



**WASHINGTON COUNTY, MARYLAND**

**PEDESTRIAN FACILITIES WITHIN PUBLIC RIGHT-OF-WAY**

**TRANSITION PLAN**

**2024**



**TABLE OF CONTENTS**

**EXECUTIVE SUMMARY .....3**

**INTRODUCTION.....5**

**ADA COORDINATOR AND IMPLEMENTING OFFICIAL .....7**

**PUBLIC NOTICE ABOUT THE ADA REQUIREMENTS .....8**

**PUBLIC INVOLVEMENT .....8**

**GRIEVANCE PROCEDURE.....9**

**SELF-EVALUATION SUMMARY .....9**

**ADA DESIGN STANDARDS .....10**

**TRANSITION PLAN .....10**

**IMPLEMENTATION SCHEDULE .....15**

**CONCLUSION .....15**

**APPENDICES**

**APPENDIX A - PROGRAM RESPONSIBILITY CONTACT INFORMATION**

**APPENDIX B –NOTICE UNDER THE AMERICANS WITH DISABILITIES ACT**

**APPENDIX C – GRIEVANCE POLICY/FORM**

**APPENDIX D – MDOT STANDARDS**

**APPENDIX E –SCHEDULE FOR IMPROVEMENTS**

## EXECUTIVE SUMMARY

The Americans with Disabilities Act (ADA) of 1990 is a civil rights law that prohibits discrimination against individuals with disabilities from receiving or having access to public service. Title II of the ADA applies to state and local governments for programs, services, activities, and prohibits discrimination against qualified individuals with disabilities.

Public agencies are required to conduct a Self-Evaluation of services, policies and practices as it relates to access for individuals with disabilities (28 CFR § 35.105(a)). Public agencies must also develop a Transition Plan to outline modifications and efforts that must be made to correct findings of non-compliance with ADA standards (28 CFR § 35.150 (d)).

Washington County took an approach implemented by other local and state governments to evaluate ADA deficiencies within public right-of-way. Washington County conducted a Self-Evaluation of all pedestrian facilities in County-maintained right-of-way. This survey included roads constructed by developers in right-of-way dedicated to public use that were subsequently accepted by the County as public right-of-way, as well as roads constructed by the County and those transferred to the County by other public agencies. The schedule of work is continually updated as projects are completed. The Self-Evaluation is available on the Washington County website.

The first step to developing the ADA Transition Plan was to analyze the inventory collected as part of the Self-Evaluation Report. This information was used to determine which facilities did not meet ADA standards. The County utilizes a priority system for each facility in the inventory. This information was used to understand the overall state of the pedestrian network as it relates to ADA standards and determine where investments can be optimized to serve the most users.

Washington County has prepared this ADA Transition Plan based upon the Self-Evaluation findings, public outreach, and collaboration with citizens and stakeholders throughout the County. This ADA Transition Plan identifies barriers to pedestrian facilities within the Washington County public right-of-way, recommends potential mitigations, estimates funding requirements, and provides a schedule to implement the mitigations.

The County determined the overall financial investment needed to bring county facilities into ADA compliance. This was done by assigning an estimated improvement cost to each noncompliant facility. Program cost information will be used to plan and schedule improvement projects. Based on the findings, it will cost approximately \$1.6 million to improve existing non-compliant facilities documented in the data inventory.

Lastly, the County developed an ADA Capital Improvement Plan program and allocated funding to make improvements each year to support projects prioritized by the methods of the ADA Transition Plan. The ADA Capital Improvement Plan Program supports the County's ongoing commitment to provide equal access to all.

The ADA Transition Plan with annual results will be updated every year to keep efforts focused on achieving improvements to access in the public right-of way. The updates will highlight progress made, refine priority areas for projects, and update the remaining program costs. The five-year update will include the update to the Self-Evaluation and a formal public comment period for the Transition Plan to continue the collaborative partnership with the community.

## INTRODUCTION

The Americans with Disabilities Act (ADA) consists of five titles outlining protections in the following areas:

Title I – Employment; Title II – Non-discrimination on the Basis of Disability in State and Local Government Services; Title III – Nondiscrimination on the Basis of Disability by Accommodations and in Commercial Facilities; Title IV – Telecommunications; and Title V – Miscellaneous Provisions.

Title II of ADA pertains to the programs, activities and services public entities provide. The County must comply with this section of the act as it specifically applies to public service agencies. Title II of ADA provides that, “...no qualified individual with a disability shall, by reason of such disability, be excluded from participation in or be denied the benefits of the services, programs, or activities of a public entity, or be subjected to discrimination by any such entity.” (42 U.S.C. § 12132; 28 CFR § 35.130).

The County is fully committed to the goal of achieving equal opportunity and non-discrimination for all persons in their interactions with the County.

The purpose of the ADA Transition Plan is to develop a strategy, timeline, and budget to bring accessible routes and intersections within the County right-of-way into compliance with ADA standards. Consistent with the aspects of Title II compliance, the elements that an ADA Transition Plan should contain are as follows:

- The name of the designated public official responsible for implementation of the improvements.
- A process for the public to report problems and request improvements to the public entity’s facilities, including grievance procedures.
- A list of physical barriers in a public entity’s facilities that do not or may not meet the requirements of the ADA regarding the accessibility of its programs, activities, or services to individuals with disabilities.
- A detailed outline of methods for removing physical barriers to make facilities accessible.
- A schedule and budget demonstrating the necessary steps to achieve compliance with Title II. If the time period for achieving compliance is longer than 1 year, the ADA Transition Plan should identify the interim steps that will be taken during each year of the transition period.
- A program to monitor the implementation and mitigate gaps.

Title II of the ADA is companion legislation to two previous federal statutes and regulations: the Architectural Barriers Acts of 1968 and Section 504 of the Rehabilitation Act of 1973.

- The Architectural Barriers Act of 1968 is a federal law that requires facilities designed, built, altered or leased with federal funds to be accessible. The Architectural Barriers Act marks one of the first efforts to ensure access to the built environment.

- Section 504 of the Rehabilitation Act of 1973 is a federal law that protects qualified individuals from discrimination based on their disability. The nondiscrimination requirements of the law apply to employers and organizations that receive financial assistance from any federal department or agency. Title II of ADA extended this coverage to all state and local government entities, regardless of whether they receive federal funding or not.

In addition to completing a Transition Plan, the County must meet the general requirements of Title II. The County:

- Must operate services, programs, or activities so that, when viewed in their entirety, they are accessible to and useable by individuals with disabilities (28 CFR § 35.150).
- May not refuse to allow a person with a disability to participate in services, programs or activities simply because the person has a disability (28 CFR § 35.130 (a)).
- May not provide benefits or services to individuals with disabilities that are separate or different than those provided to others unless the separate or different measures are necessary to ensure that benefits and services are equally effective (28 CFR § 35.130(b)(1)(iv) & (d)).
- Must make reasonable modifications in policies, practices and procedures to ensure equal access to individuals with disabilities unless modifications would fundamentally alter the nature of the service, program or activity (28 CFR § 35.130(b) (7)).
- Must take appropriate steps to ensure that communications with applicants, participants, and members of the public with disabilities are as effective as communications with others (28 CFR § 35.160(a)).
- Must designate at least one responsible employee to coordinate ADA compliance (28 CFR § 35.107(a)). This person is often referred to as the "ADA Coordinator." The public entity must provide the ADA Coordinator's name, office address, and telephone number to all interested individuals.
- Must provide notice of ADA requirements. The notice must provide information about the provisions of Title II and its applicability to services, programs or activities (28 CFR § 35.106).
- Must adopt and publish grievance procedures providing for prompt and equitable resolution of complaints (28 CFR § 35.107(b)).

This Transition Plan only addresses existing county-owned public right-of-way. County-owned buildings and parks are addressed in a separate document.

## **ADA COORDINATOR AND IMPLEMENTING OFFICIAL**

As required by the ADA, public agencies with 50 or more employees must designate at least one responsible employee to coordinate ADA compliance and investigate complaints/requests. This individual is responsible for reviewing potential violations of the ADA and addressing ADA concerns from the general public and from other departments and employees of the public entity.

In accordance with 28 CFR § 35.107(a), the County has identified an ADA Coordinator to oversee the county policies and procedures.

The designated ADA coordinator for Washington County's public right-of-way is the:

Director of Human Resources  
100 West Washington Street  
Hagerstown, MD 21740

The Director of Human Resources serves as the primary contact for the ADA policies, practices, and procedures that relate to Washington County's public right-of-way. Requests for information, questions, complaints, or grievances should be initially directed to the ADA Coordinator.

The Implementing Official has a broader scope of responsibility and can recommend policy or budget actions necessary to implement provisions of the ADA Transition Plan. The ADA Implementing Official for Washington County's public right-of-way is the:

Director of Engineering  
747 Northern Avenue  
Hagerstown, MD 21742

The Director of Engineering is the official responsible, under 28 CFR § 35.150(d)(3)(iv) for the implementation of the ADA Transition Plan for Public Right-of-Way.

The County official responsible for sidewalk, roadway and traffic signal maintenance is the:

Director of Public Works  
100 W. Washington Street  
Hagerstown, MD 21740

The Director of Public Works is the official responsible, under 28 CFR § 35.133(a), for maintenance of all accessible features of facilities.

Contact information for the above-referenced County Officials is included in Appendix A.

## **PUBLIC NOTICE ABOUT THE ADA REQUIREMENTS**

Under Title II of the Americans with Disabilities Act (28 CFR § 35.106), each agency is required to publish notice of its responsibilities with regards to the ADA. This public notice is provided as Appendix B and can also be found on the County webpage.

Washington County has provided public notice of the ADA Transition Plan via an accessible web page on the Washington County website. Providing notice is an on-going responsibility. Staff will notify the public of any ADA Transition Plan updates, and a .pdf version of this ADA Transition Plan has been made available on the website.

## **PUBLIC INVOLVEMENT**

As part of the Self-Evaluation and Transition Plan requirement per Title II of the ADA, public entities are required to engage in meaningful public participation during the drafting of the ADA Transition Plan. Public entities must accept comments from the public on the ADA Transition Plan and are strongly encouraged to consult with individuals with disabilities and organizations that represent these individuals to assist in the self-evaluation process.

28 CFR § 35.150(d)(1) requires public entities to “provide an opportunity to interested persons, including individuals with disabilities or organizations representing individuals with disabilities, to participate in the development of the Transition Plan by submitting comments.”

Washington County’s primary goals for conducting public outreach on the ADA Transition Plan are to inform the public about the County’s plan and processes regarding removal of barriers to accessibility within the County public right-of-way and to identify gaps in the proposed ADA Transition Plan.

A record of public involvement to date is included in the Self-Evaluation. The table below provides a summary of the comments received to date.

**Table 1: Summary of Public Comments to Date**

<b>Comment</b>	<b>Response</b>
Halfway Blvd and Virginia Ave intersection. Request for curb ramps.	MDOT SHA intersection. MDOT SHA to review request.
Washington County Library. Request for additional ADA parking.	Verified number of ADA parking spaces for the new building is appropriate.
Edgewood Drive in Funkstown. No existing sidewalk. Request for sidewalk installation.	Project will be considered during the Capital Improvement Plan review process.

The current Transition Plan is posted on the website, and the public can submit comments via link to a designated ADA comments e-mail box.

The County will continue to provide the latest information for projects and policy on the webpage including updates to this plan.



## **GRIEVANCE PROCEDURE**

Pursuant to requirements of applicable federal regulations, the Board of County Commissioners of Washington County, Maryland, has adopted this grievance procedure to provide for prompt and equitable resolution of complaints under section 504 of the Rehabilitation Act of 1973 and amendments (the “Rehabilitation Act”), and the Americans with Disabilities Act of 1990 and amendments (the “ADA”). It is intended for use by any individual who wishes to file a complaint alleging discrimination on the basis of disability in the access of facilities or provision of services, activities, programs, or benefits by the Board of County Commissioners of Washington County, Maryland. The Board of County Commissioners of Washington County, Maryland’s Personnel Policy PR-31 governs employment-related complaints of disability discrimination.

The Grievance Form should be used by any individual who wishes to file a complaint alleging discrimination on the basis of disability in employment practices and policies or the provision of programs, services and benefits by the Washington County Commissioners. A complainant can request reconsideration of the case in instances where he or she is dissatisfied with the resolution. A copy of the Grievance Procedure and Complaint Form is included as Appendix C.

## **SELF-EVALUATION SUMMARY**

The County is required under Title II of the Americans with Disabilities Act (ADA) and 28 CFR § 35.105 to perform a self-evaluation of its current transportation infrastructure policies, practices, and programs. The Self-Evaluation Plan identifies what policies and practices impact accessibility and examines how the County implements these policies. Any barriers to accessibility identified in the Self-Evaluation Plan and the remedy to the identified barrier are set out in this transition plan, as required in 28 CFR § 35.150 (d)(3)(i). Washington County updates its inventory of pedestrian facilities within its public right-of-way every five years. The summary of the results is detailed in the Self-Evaluation (as an appendix).

### **Overview**

The pedestrian facilities specifically addressed in the Self-Evaluation for this Transition Plan are sidewalks and curb ramps. Any barriers to accessibility resulting from these facilities are identified.

The County will update this information periodically as new facilities are constructed, existing facilities are improved, and County policies and/or practices change. These updates will ensure the inventory remains current as we make progress with the Transition Plan implementation.

## **ADA DESIGN STANDARDS**

The Architectural and Transportation Barrier Compliance Board (alternatively called the Access Board) developed accessibility guidelines for pedestrian facilities in the public right-of-way. The Federal Highway Administration has recognized these as its currently recommended best practices. The Maryland Department of Transportation (MDOT) develops, maintains, and publishes ADA compliant design standards for use on transportation facilities in Maryland's public right-of-way. To promote consistency, the County utilizes MDOT design standards for its transportation facilities. All new County roadway construction and reconstruction will conform to the MDOT design standards that apply to ADA. MDOT Standard details are provided as Appendix D and on the County website.

## **TRANSITION PLAN IMPLEMENTATION**

Title II of the ADA requires that public entities having responsibility for or authority over facilities, streets, sidewalks, and/or other areas meant for public use develop a transition plan to ensure their facilities meet the standards for program accessibility.

### **Methods Used to Improve Accessibility**

The County will maintain and improve accessibility of pedestrian facilities in the public right-of-way using a variety of methods and programs. The program that is expected to have the largest impact is the Capital Improvement Program. However, there are other programs such as sidewalk maintenance, signal improvements, road resurfacing, and developer improvements that will also result in accessibility improvements in the public right-of-way.

### **Capital Improvement Program**

The County has developed an ADA Capital Improvement Program to implement the ADA Transition Plan by retrofitting and replacing existing pedestrian facilities with new accessible facilities. By design, the Transition Plan only addresses existing facilities that are not ADA compliant; therefore, it does not include expansion of the sidewalk network. Projects in this program will be prioritized by the methods described herein. The projects developed through this program will be stand-alone ADA improvement projects and will be built by public contract. The goal of the ADA Capital Improvement Program is to have several projects each year according to the priorities and budgeted funding.

## **Sidewalk Maintenance**

The County Division of Public Works employees provide maintenance activities including vegetation trimming, crack filling, grinding vertical surface discontinuities, and maintaining sidewalks and paths in the public right-of-way. This program will generally address maintenance issues that appear over time as a result of the sidewalk or pedestrian path's age or usage. This program will not generally be used to correct non-compliant deficiencies in the original design and construction of sidewalk, such as steep cross slopes or narrow pedestrian access routes.

## **Traffic Signal Improvements**

The County Highway Department employees maintain the County's traffic signals and accessible pedestrian signals. Major modifications such as adding or relocating accessible pedestrian signals will generally be part of a capital improvement project. The County will provide repairs to existing systems as needed.

## **Roadway Resurfacing Programs**

The County preserves its roadways through a pavement maintenance program. Some roadway resurfacing treatments result in alterations to crosswalks, which trigger requirements for accessible curb ramps. When determining whether a roadway resurfacing treatment constitutes an alteration of a pedestrian facility, the County will follow the guidance of the Department of Justice / Department of Transportation Joint Technical Assistance on the Title II of the Americans with Disabilities Act Requirements to Provide Curb Ramps when Streets, Roads, or Highways are Altered through Resurfacing" published in 2013 and the "Questions & Answers Supplement to the 2013 DOJ/DOT Joint Technical Assistance on the Title II of the Americans with Disabilities Act Requirements To Provide Curb Ramps when Streets, Roads, or Highways are Altered through Resurfacing" published in 2015. The County provides curb ramp upgrades as a part of the pavement maintenance program.

## **Developer Improvements**

When private developments alter existing pedestrian facilities in the public right-of-way, the County requires the developer to make improvements. The County also reviews development plans to ensure compliance with ADA standards.

## **Funding Opportunities**

This County identifies that \$50,000 to \$100,000 annually through fiscal year 2034 will be committed to the correction of ADA deficiencies. The funding for corrective measures comes from the Capital Improvement Plan (General Fund or Grant Funds) as it annually commits funds to Transportation ADA projects for curb ramp and sidewalk improvements. ADA accessibility improvements are also provided on road, bridge, or facility projects listed separately in the Capital Improvement Plan.

## **Prioritization**

After collecting a detailed inventory of existing facilities as part of the Self-Evaluation data, the County needed a way to compare these facilities for deficiencies and ultimately determine a process for planning improvement projects.

The primary goal of the ADA Transition Plan is to identify and remove all barriers within the County right-of-way. While it is critical to remove barriers and provide accessibility to all individuals with disabilities, it is simply not feasible to immediately eliminate all barriers. Therefore, it is necessary to have a system for prioritizing needed improvements to best utilize available resources.

The schedule for removing barriers in the County's public right-of-way included as Appendix E was developed using guidelines identified in Title II regulation §35.150(d)(2).

*If a public entity has responsibility or authority over streets, roads, or walkways, its transition plan shall include a schedule for providing curb ramps or other sloped areas where pedestrian walks cross curbs, giving priority to walkways serving entities covered by the Act, including State and local government offices and facilities, transportation, places of public accommodation, and employers, followed by walkways serving other areas.*

Based on these guidelines, the prioritization criteria for removal of barriers in the right-of-way include the following:

- Locations serving government offices and public facilities;
- Locations serving transportation;
- Locations serving commercial districts and employers; and
- Locations serving other areas.

In addition to the required criteria, the County has prioritized the following:

- Location of citizen complaint/request (ADA Title II Program Access)

## **Barrier Priorities and Categories**

Matrices included on the following pages illustrate the prioritization criteria for curb ramps and sidewalks barrier removal projects in the County's public right-of-way. Each facility evaluated was assigned a rank based on its barrier priority and category. The priority given is based on the information described above, and the barrier category is based on the condition of the facility. The description for each category is provided after each matrix.

The columns in the matrix indicate the assigned priority and are in order of importance from left to right, with the left column having the highest importance. The rows indicate the category of condition assigned to each facility during the evaluation process, with the top row having the highest importance. The table shading indicates the priority rank with the darkest shading indicating the highest priority when the priorities and categories are combined. Each matrix is

followed by a description of the barrier categories, a table summarizing removal actions by barrier priority, and maps showing each identified barrier’s location.

The following pages describe the types of facilities evaluated and summarize the barrier findings as follows:

- A matrix showing priorities by category;
- Description of the barrier categorizations; and
- Summary tables of the identified barriers; and
- Maps showing the locations of identified barriers.

In addition to the required criteria, the County has prioritized the following:

- Locations of citizen complaint or request (ADA title II program access).

**ADA Priorities:**

Priorities (Categories)	Priority Description	A Location of Citizen ADA Complaint and/or Request	B Location Serving Governmental Offices & Public Facilities	C Location Serving Transportation	D Location Serving Commercial Districts, Employers	E Location Serving Other Areas
1	See Category 1 Description	A1	B1	C1	D1	E1
2	See Category 2 Description	A2	B2	C2	D2	E2
3	See Category 3 Description	A3	B3	C3	D3	E3
4	See Category 4 Description	A4	B4	C4	D4	E4
5	No Deficiencies Identified	A5	B5	C5	D5	E5

**Curb Ramp Barrier Descriptions**

Category 1:

- The curb ramp is significantly damaged or deteriorated.
- Existing sidewalk with no curb ramp access or where there is an obstruction to accessing the curb ramp.
- The curb ramp has no detectable warning (truncated domes).
- The curb ramp directs pedestrians into the vehicle travel lane (i.e., located outside of a crosswalk).

Category 2:

- The curb ramp’s surface is not firm, stable, and/or slip resistant.
- Diagonal curb ramp design with existing physical constraints (including but not limited to obstruction, steep running slope or cross slope, non-compliant clear space or turning space, non-compliant width or lip height, etc.).
- The curb ramp has a lip or vertical discontinuity of greater than 1/4 inch.
- Width of the ramp is less than 36 inches.

- Turning space is less than 2 by 2 feet and/or the slope exceeds 4%.
- The curb ramp detectable warning is not located within marked crossings (when present).
- Clear space at the bottom of the ramp outside of the travel lane is less than 2 by 2 feet.

Category 3:

- Running slope of ramp exceeds 8.33%, or 5% for blended transition.
- Cross slope of ramp exceeds 3%.
- Counter slope of ramp is greater than 5%.
- Parallel curb ramp with constrained turning space on two or more sides is less than 4 by 5 feet.
- Turning space is less than 4 by 4 feet.
- Clear space at the bottom of the ramp outside of the travel lane is less than 4 by 4 feet.
- The curb ramp has a lip or vertical discontinuity equal to or between 1/4 inch and 1/2 inch.
- Grade break is not perpendicular to ramp.

Category 4:

- The curb ramp has a lip or vertical discontinuity greater than 1/4 inch.
- The detectable warning surface does not meet ADA Accessibility Guidelines or PROWAG standards.
- Cross slope of ramp exceeds 2%.

Category 5:

- No deficiencies identified.

## **Sidewalk Barrier Descriptions**

Category 1:

- The sidewalk has no detectable warning (truncated domes).
- The sidewalk width is less than 48 inches.

Category 2:

- Barrier located along an arterial or collector.
  - Running slope of sidewalk exceeds grade of road and is greater than 5%.
  - Sidewalk has cross slopes that exceed 2% more than half of the sidewalk segment.
  - Sidewalk cross slope at driveway entries exceeds 2%.
  - Sidewalk has a significant number of vertical changes that exceed a quarter inch and openings greater than a half inch or are parallel to direction of travel (more than one per 100 feet).

Category 3:

- Barrier located along a local road.
  - Running slope of sidewalk exceeds grade of road and is greater than 5%.
  - Sidewalk has cross slopes that exceed 2% more than half of the sidewalk segment.
  - Sidewalk cross slope at driveway entries exceeds 2%.

- Sidewalk has a significant number of vertical changes that exceed a quarter inch and openings greater than a half inch or are parallel to direction of travel (more than one per 100 feet).

Category 4:

- Sidewalk has cross slopes that exceed 2% less than half of the sidewalk segment.
- Sidewalk has a significant number of vertical changes that exceed a quarter inch or openings greater than a half inch (more than one per 100 feet), but not both.
- Overhanging or protruding objects along sidewalk route.

Category 5:

- No deficiencies identified.

## **IMPLEMENTATION SCHEDULE**

Title II regulations state that if a transition plan will take more than one year to fully implement, it must contain interim steps to provide program accessibility. Based on a diligent effort by County staff, the Plan proposes a 20-year strategy for removing barriers within the public right-of-way. The barrier removal strategy incorporates flexibility in the process and allows the County to respond to new opportunities as they arise. The County reserves the right to modify barrier removal priorities to allow flexibility in accommodating community requests, petitions for reasonable modifications from people with disabilities, changes in County programs, and funding opportunities and constraints. For the most current status of the remediation of barriers, contact the County's ADA Implementing Official.

Washington County will allocate \$50,000 to \$100,000 per year for sidewalk and curb ramp improvements through Transportation ADA funding in the County's Capital Improvement Plan.

## **CONCLUSION**

Washington County recognizes pedestrian facilities as an integral part of its transportation infrastructure. The field inspections conducted for the Self-Evaluation provided a valuable baseline for measuring progress towards the goal of fully accessible pedestrian facilities within Washington County right-of-way. This Transition Plan will continue to be updated as conditions within the County evolve.

## APPENDIX A

### PROGRAM RESPONSIBILITY

The officials responsible for ADA Compliance in Washington County are:

ADA Compliance Coordination:

Director of Human Resources/  
ADA Title II Compliance Coordinator  
Human Resources Department  
Chip Rose  
100 W. Washington Street, Room 251  
Hagerstown, MD 21740  
Phone: (240) 313-2356  
Email: [crose@washco-md.net](mailto:crose@washco-md.net)

Implementation of the County's ADA Transition Plan for public right-of-way, sidewalks, curb ramps, traffic signals/intersection:

Director, Division of Engineering  
Scott Hobbs  
747 Northern Avenue  
Hagerstown, MD 21742  
Phone: (240) 313-2407  
Email: [shobbs@washco-md.net](mailto:shobbs@washco-md.net)

Implementation of the County's ADA Transition Plan for buildings and parks/outdoor facilities:

Director, Division of Public Works  
Andrew Eshleman  
100 W. Washington Street  
Hagerstown, MD 21740  
Phone: (240) 313-2252  
Email: [aeshleman@washco-md.net](mailto:aeshleman@washco-md.net)



## Appendix B

### NOTICE UNDER THE AMERICANS WITH DISABILITIES ACT

In accordance with the requirements of Title II of the Americans with Disabilities Act of 1990 (“ADA”), the Board of County Commissioners of Washington County, Maryland, and Washington County, Maryland (collectively, “County”), will not discriminate against qualified individuals with disabilities on the basis of disability in the access of facilities or provision of County services, activities, programs, or benefits.

**Employment:** The County does not discriminate on the basis of disability in its hiring or employment practices and complies with all regulations promulgated by the U.S. Equal Employment Opportunity Commission under Title I of the ADA.

**Effective Communication:** The County will generally, upon request, provide appropriate aids and services leading to effective communication for qualified persons with disabilities so they can participate in the County’s programs, services, and activities, including qualified sign language interpreters, audio recordings of meetings or programs, and other ways of making information and communications accessible to people who have speech, hearing, or vision impairments.

**Modifications to Policies and Procedures:** The County will make all reasonable modifications to policies and programs to ensure that people with disabilities have an equal opportunity to enjoy all of the County’s services, activities, programs, and benefits. For example, individuals with service animals are welcomed in the County’s offices, even where pets are generally prohibited.

Anyone who requires an auxiliary aid or service for effective communication, or a modification of policies or procedures to participate in a County program, service, or activity, should contact the office Chip Rose, ADA Title II Coordinator for Washington County, Maryland, at 100 West Washington Street, Hagerstown, Maryland 21740, telephone (240)-313-2353, email [crose@washco-md.net](mailto:crose@washco-md.net), as soon as reasonably possible before the scheduled event.

The ADA does not require the County to take any action that would fundamentally alter the nature of its services, activities, programs, or benefits, or that would impose an undue financial or administrative burden on the County.

**Grievance Procedure:** Complaints that a County facility, service, activity, program, or benefit is not accessible to persons with disabilities on the basis of disability discrimination should be directed to Debra Condo, ADA Title II Coordinator for Washington County, Maryland, at 100 West Washington Street, Hagerstown, Maryland 21740, telephone (240)-313-2353. Detailed information about filing a complaint is contained in the County’s Grievance Procedure under the Americans with Disabilities Act.

The County will not place a surcharge on a particular individual with a disability or any group of individuals with disabilities to cover the cost of providing auxiliary aids or services, or reasonable modifications of policy, such as retrieving items from locations that are open to the public but are not accessible to persons who use wheelchairs.

## Appendix C

### Complaint/Grievance Policy

Washington County has updated the internal grievance procedure providing for prompt and equitable resolution of complaints alleging any action prohibited by the U.S. Department of Justice regulations implementing Title II of the Americans with Disabilities Act (ADA). Title II states, in part, that "no otherwise qualified disabled individual shall, solely by reason of such disability, be excluded from the participation in, be denied the benefits of, or be subjected to discrimination" in programs or activities sponsored by a public entity.

Complaints related to the Title II of the ADA should be addressed to the Health and Human Services Department Director, Chip Rose (240-313-2356, [crose@washco-md.net](mailto:crose@washco-md.net)). Ms. Condo is responsible for County-wide ADA compliance.

1. A complaint must be filed in writing and must contain the name and address of the person filing it and a brief description, including the date and location, of the alleged violation. If necessary, an alternative means of filing the complaint or receiving the response may be requested.
2. Complaints should be filed in as timely a manner as possible but no later than 60 business days after the alleged violation.
3. An investigation by the ADA Compliance Officer or designee, as may be appropriate, shall follow a filing of complaint. These rules contemplate informal but thorough investigations, affording all interested persons and their representatives, if any, an opportunity to submit evidence relevant to a complaint.
4. The ADA Compliance Officer or designee will provide a response in writing, or in an alternative format if requested, to the complainant within 30 business days after the complaint is received.
5. The complainant can request a reconsideration of the case in instances where he or she is dissatisfied with the resolution. The request for reconsideration should be made in writing, or in an alternative format upon request, to the County Administrator within 30 business days of receiving the ADA Compliance Officer's decision.
6. The County Administrator or designee will review the complaint, conduct an additional investigation if appropriate, and respond to the complainant in writing, or in an alternative format upon request, within 30 business days after receipt of the request for reconsideration. A copy of the County Administrator's response will be forwarded to the ADA Compliance Officer.
7. The ADA Compliance Officer will maintain copies of all written ADA complaints, appeals to the County Administrator, and responses from these two offices for at least 3 years.
8. These rules shall be construed to protect the substantive rights of interested persons to meet appropriate due process standards and to assure that Washington County complies with the ADA and implementing regulations.
9. Use of this grievance process does not preclude the complainant from filing an administrative complaint with the designated federal agency or filing a lawsuit for injunctive relief and damages. An individual may choose to pursue any or all of these methods.



# APPENDIX D – MDOT STANDARDS

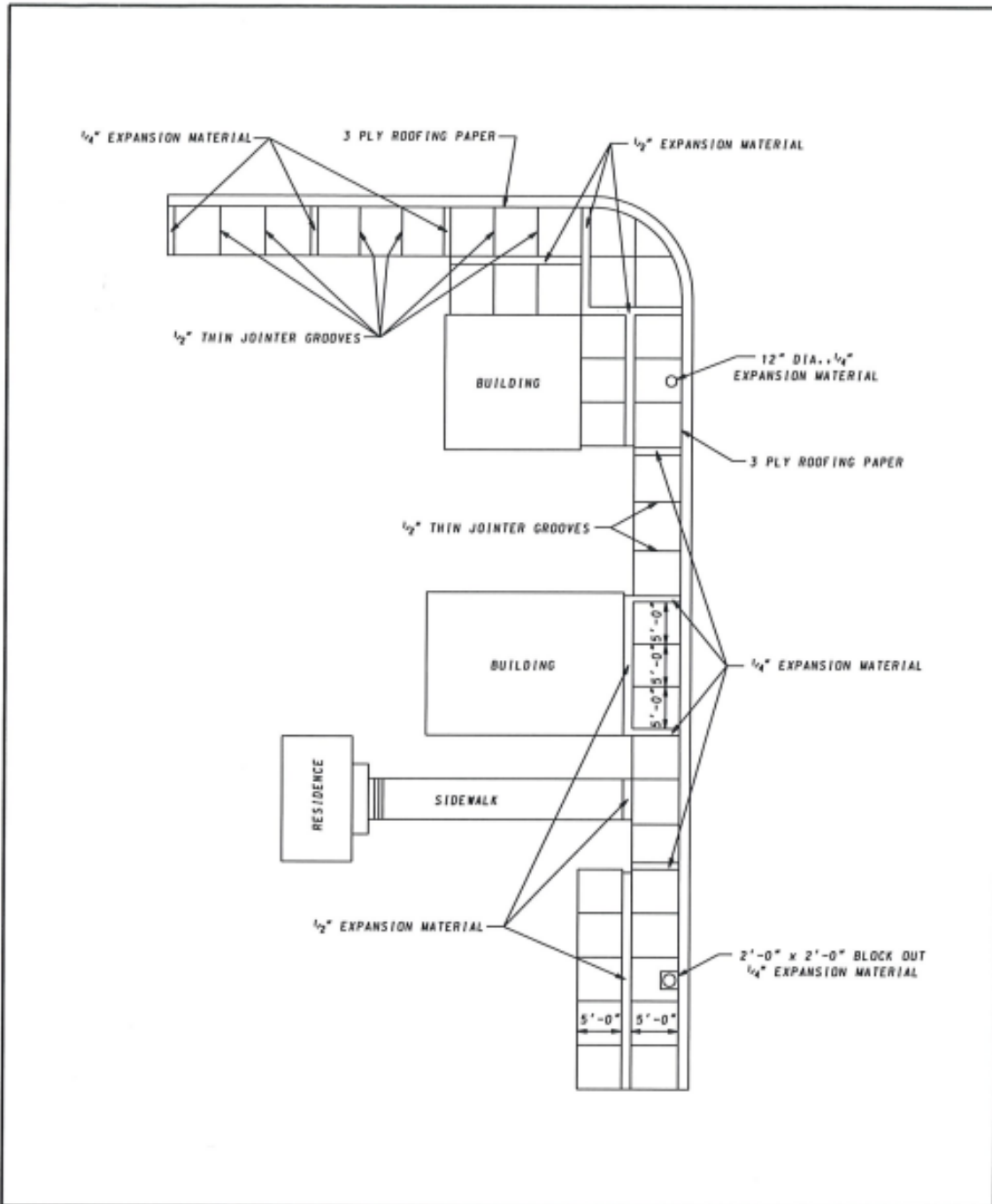

SPECIFICATION	CATEGORY CODE ITEMS										
APPROVED	<i>Kirk G. McCall</i> DIRECTOR - OFFICE OF HIGHWAY DEVELOPMENT										
	<table border="1"> <tr> <td>APPROVAL • DVA REVISIONS</td> <td>APPROVAL • FEDERAL HIGHWAY ADMINISTRATION</td> </tr> <tr> <td>APPROVAL 3-11-64</td> <td>APPROVAL 6-9-64</td> </tr> <tr> <td>REVISED 10-1-01</td> <td>REVISED</td> </tr> <tr> <td>REVISED</td> <td>REVISED</td> </tr> <tr> <td>REVISED</td> <td>REVISED</td> </tr> </table>	APPROVAL • DVA REVISIONS	APPROVAL • FEDERAL HIGHWAY ADMINISTRATION	APPROVAL 3-11-64	APPROVAL 6-9-64	REVISED 10-1-01	REVISED	REVISED	REVISED	REVISED	REVISED
	APPROVAL • DVA REVISIONS	APPROVAL • FEDERAL HIGHWAY ADMINISTRATION									
	APPROVAL 3-11-64	APPROVAL 6-9-64									
	REVISED 10-1-01	REVISED									
REVISED	REVISED										
REVISED	REVISED										

**Maryland Department of Transportation**  
**STATE HIGHWAY ADMINISTRATION**  
 STANDARDS FOR HIGHWAYS AND INCIDENTAL STRUCTURES  
  
**SIDEWALK EXPANSION JOINTS**  
  
**STANDARD NO. MD 655.01**

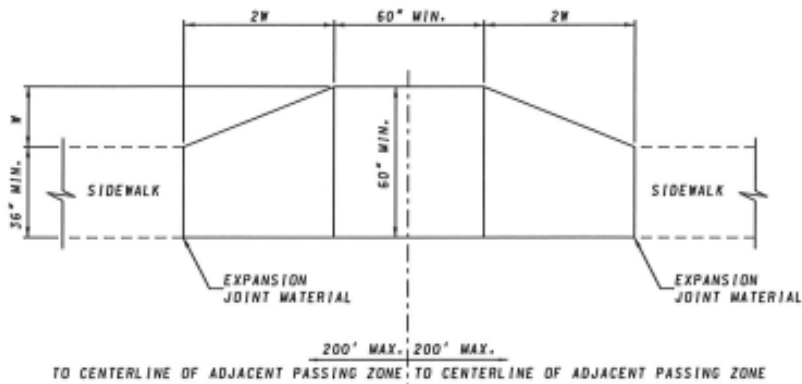

**PLAN**

**NOTES**

1. WHERE THE CONTINUOUS WIDTH FOR TRAVEL IS LESS THAN 60', SIDEWALK PASSING ZONES SHALL BE PROVIDED AT AN INTERVAL NOT TO EXCEED 200'. USE OF ENTRANCES AND LEADER WALKS AS PASSING ZONES IS ACCEPTABLE PROVIDED THAT THE GEOMETRY MEETS THE REQUIREMENTS OF THIS STANDARD.
2. SIDEWALK PASSING ZONES SHALL BE LOCATED AS INDICATED ON DRAWINGS, HOWEVER EXISTING LIGHT POLES, FIRE HYDRANTS, DROP INLETS, ETC. MAY AFFECT PLACEMENT.
3. SIDEWALK TRANSVERSE SLOPE SHALL BE MAINTAINED ACROSS THE ENTIRE WIDTH OF THE PASSING ZONE (4B:1 MAX.).

SPECIFICATION <b>603</b>	CATEGORY CODE ITEMS	<p><b>Maryland Department of Transportation</b>  <b>STATE HIGHWAY ADMINISTRATION</b>          STANDARDS FOR HIGHWAYS AND INCIDENTAL STRUCTURES</p> <p><b>SIDEWALK PASSING ZONES</b></p> <p><b>STANDARD NO. MD 655.02</b></p>	
APPROVED	 DIRECTOR - OFFICE OF HIGHWAY DEVELOPMENT		
	APPROVAL • SHA REVISIONS APPROVAL 2-18-04		APPROVAL • FEDERAL HIGHWAY ADMINISTRATION APPROVAL 3-31-04
	REVISED		REVISED
	REVISED	REVISED	

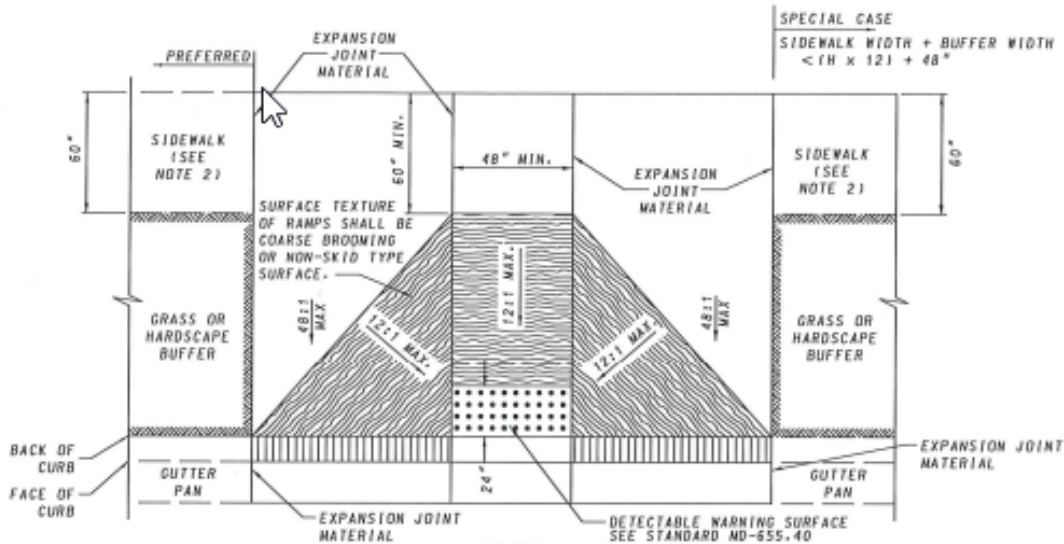

**PLAN**

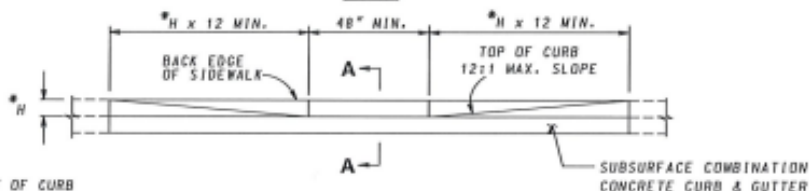

**ELEVATION**

\* - H = HEIGHT OF CURB  
ALL MEASUREMENTS IN INCHES

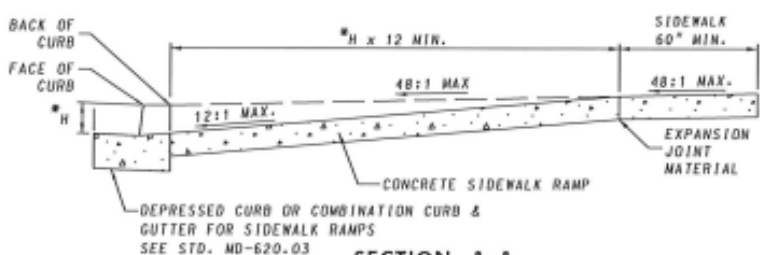

**SECTION A-A**

**NOTES**

1. TO BE USED ON WIDE SIDEWALKS OR SIDEWALKS WITH SIGNIFICANT SEPARATION FROM THE ROADWAY WHERE THE GEOMETRY SPECIFIED IN THE DETAILS ABOVE CAN BE SATISFIED. MAY BE MODIFIED TO SUIT A PARTICULAR LOCATION.
2. WHERE 60" SIDEWALK CAN NOT BE PROVIDED, A DESIGN WAIVER MUST BE REQUESTED
3. NO TRAVERSABLE SLOPE ON THE RAMP OR SIDEWALK SHALL EXCEED 12:1 IN THE DIRECTION OF PEDESTRIAN TRAVEL, OR 48:1 PERPENDICULAR TO THE DIRECTION OF PEDESTRIAN TRAVEL.
4. EXPANSION JOINT MATERIAL SHALL BE INSTALLED IN ACCORDANCE WITH STD. MD-655.01.
5. SIDEWALK RAMPS TO BE SHOWN ON PLANS SYMBOLICALLY AND REFERENCED WITH THE CENTER OF THE RAMP ALIGNED TO A STATION ON THE CONSTRUCTION CENTERLINE. SEPARATE DETAILS SHALL BE SHOWN WHERE PROPOSED RAMP VARIES FROM STANDARD CASES.
6. TRANSITION PANELS TO TIE INTO EXISTING SIDEWALK MUST BE A MINIMUM OF 5' IN LENGTH.

SPECIFICATION <b>603 &amp; 611</b>	CATEGORY CODE ITEMS										
APPROVED	<i>[Signature]</i> DIRECTOR - OFFICE OF HIGHWAY DEVELOPMENT										
<b>SHA</b> State Highway Administration	<table border="1"> <tr> <td>APPROVAL • SHA REVISIONS</td> <td>APPROVAL • FEDERAL HIGHWAY ADMINISTRATION</td> </tr> <tr> <td>APPROVAL 2-18-04</td> <td>APPROVAL 3-31-04</td> </tr> <tr> <td>REVISED 3-25-08</td> <td>REVISED 4-5-06</td> </tr> <tr> <td>REVISED 6-2-14</td> <td>REVISED 5-28-14</td> </tr> <tr> <td>REVISED</td> <td>REVISED</td> </tr> </table>	APPROVAL • SHA REVISIONS	APPROVAL • FEDERAL HIGHWAY ADMINISTRATION	APPROVAL 2-18-04	APPROVAL 3-31-04	REVISED 3-25-08	REVISED 4-5-06	REVISED 6-2-14	REVISED 5-28-14	REVISED	REVISED
APPROVAL • SHA REVISIONS	APPROVAL • FEDERAL HIGHWAY ADMINISTRATION										
APPROVAL 2-18-04	APPROVAL 3-31-04										
REVISED 3-25-08	REVISED 4-5-06										
REVISED 6-2-14	REVISED 5-28-14										
REVISED	REVISED										

**Maryland Department of Transportation  
STATE HIGHWAY ADMINISTRATION**  
STANDARDS FOR HIGHWAYS AND INCIDENTAL STRUCTURES

**SIDEWALK RAMPS  
PERPENDICULAR**

**STANDARD NO. MD 655.11**

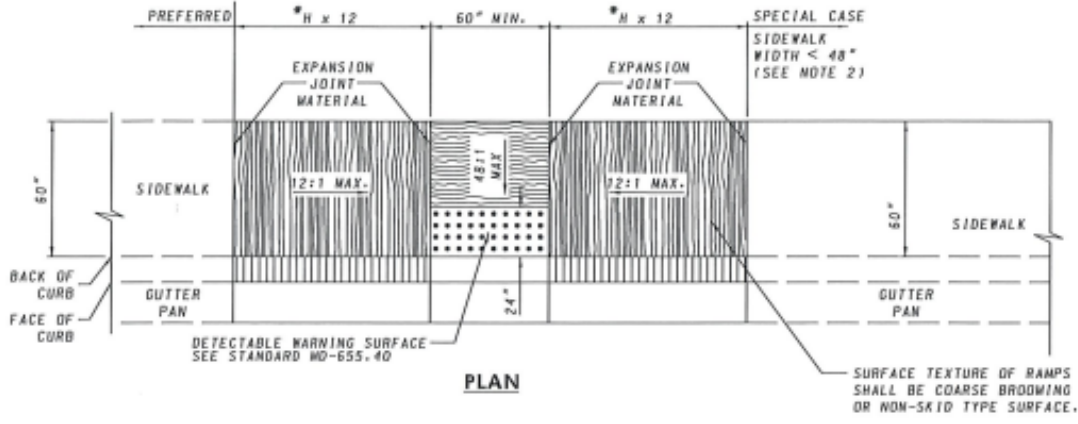

**PLAN**

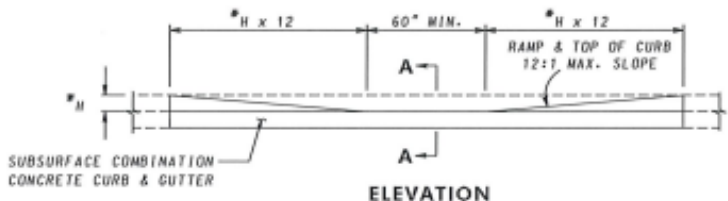

**ELEVATION**

\* - H = HEIGHT OF CURB  
ALL MEASUREMENTS IN INCHES

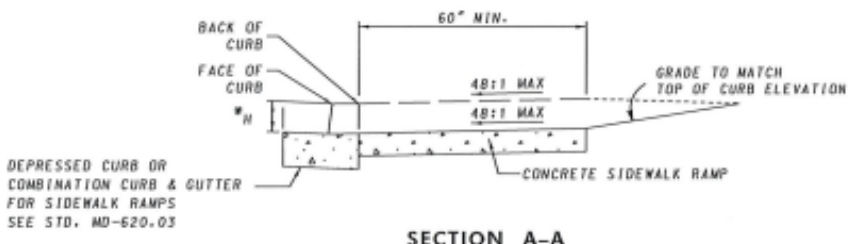

**SECTION A-A**

**NOTES**

1. TO BE USED WHERE SIDEWALK IS ADJACENT TO THE CURB. THIS STANDARD MAY BE MODIFIED TO SUIT A PARTICULAR LOCATION.
2. WHERE 60" SIDEWALK CAN NOT BE PROVIDED, A DESIGN WAIVER MUST BE REQUESTED.
3. NO TRAVERSABLE SLOPE ON THE RAMP OR SIDEWALK SHALL EXCEED 12:1 IN THE DIRECTION OF PEDESTRIAN TRAVEL, OR 48:1 PERPENDICULAR TO THE DIRECTION OF PEDESTRIAN TRAVEL. THE CROSS-SLOPE OF THE LANDING AREA CANNOT EXCEED GRADE OF ROADWAY.
4. EXPANSION JOINT MATERIAL SHALL BE INSTALLED IN ACCORDANCE WITH STD. MD-655-01.
5. SIDEWALK RAMPS TO BE SHOWN ON PLANS SYMBOLICALLY AND REFERENCED WITH THE CENTER OF THE RAMP ALIGNED TO A STATION ON THE CONSTRUCTION CENTERLINE. SEPARATE DETAILS SHALL BE SHOWN WHERE PROPOSED RAMP VARIES FROM STANDARD CASES.
6. TRANSITION PANELS TO TIE INTO EXISTING SIDEWALK MUST BE A MINIMUM OF 5' IN LENGTH.

SPECIFICATION <b>603 &amp; 611</b>	CATEGORY CODE ITEMS
APPROVED	DIRECTOR - OFFICE OF HIGHWAY DEVELOPMENT
	APPROVAL - SHA REVISIONS
	APPROVAL - FEDERAL HIGHWAY ADMINISTRATION
	REVISIONS
	REVISIONS
	REVISIONS

**Maryland Department of Transportation**  
**STATE HIGHWAY ADMINISTRATION**  
 STANDARDS FOR HIGHWAYS AND INCIDENTAL STRUCTURES  
**SIDEWALK RAMPS**  
**PARALLEL**

**STANDARD NO. MD 655.12**

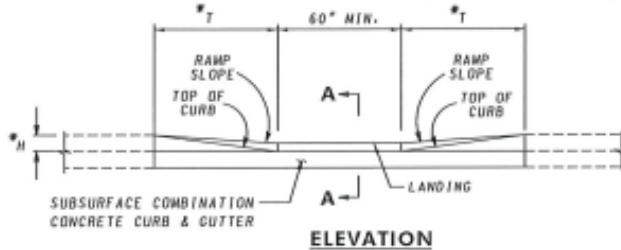
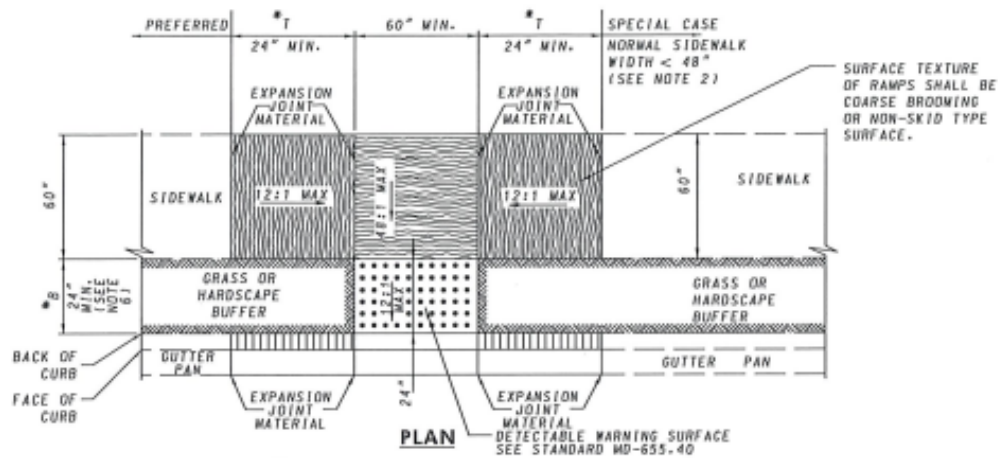

- \* - H = HEIGHT OF CURB
- B = BUFFER WIDTH (BACK OF CURB TO FRONT OF SIDEWALK)
- T = TRANSITION LENGTH (LENGTH OF RAMP FROM SIDEWALK TO LANDING)
- $T = (12 \times H) - B$
- ALL MEASUREMENTS IN INCHES

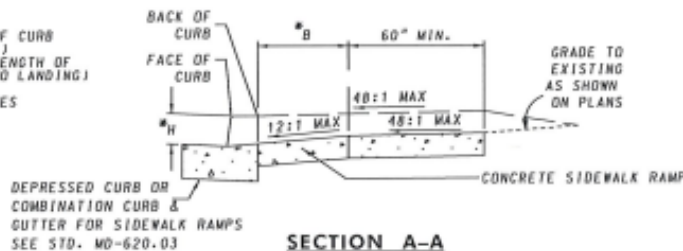

**NOTES**

1. TO BE USED WHERE AT LEAST 7'-0" EXISTS BETWEEN THE BACK OF CURB AND THE BACK OF SIDEWALK. THIS STANDARD MAY BE MODIFIED TO SUIT A PARTICULAR LOCATION.
2. WHERE 60" SIDEWALK CAN NOT BE PROVIDED, A DESIGN WAIVER MUST BE REQUESTED.
3. NO TRAVERSABLE SLOPE ON THE RAMP OR SIDEWALK SHALL EXCEED 12:1 IN THE DIRECTION OF PEDESTRIAN TRAVEL, OR 48:1 PERPENDICULAR TO THE DIRECTION OF PEDESTRIAN TRAVEL.
4. EXPANSION JOINT MATERIAL SHALL BE INSTALLED IN ACCORDANCE WITH STD. MD-655.01.
5. SIDEWALK RAMPS TO BE SHOWN ON PLANS SYMBOLICALLY AND REFERENCED WITH THE CENTER OF THE RAMP ALIGNED TO A STATION ON THE CONSTRUCTION CENTERLINE. SEPARATE DETAILS SHALL BE SHOWN WHERE PROPOSED RAMP VARIES FROM STANDARD CASES.
6. FOR BUFFER WIDTHS LESS THAN 24", WIDEN SIDEWALK TO BACK OF CURB AS SHOWN FOR THE SPECIAL CASE. THEN BUILD PARALLEL RAMP USING STANDARD MD-655.12.
7. TRANSITION PANELS TO TIE INTO EXISTING SIDEWALK MUST BE A MINIMUM OF 5' IN LENGTH
8. IF THE BUFFER AREA IS GREATER THAN OR EQUAL TO 4' THE LANDING AREA MUST BE 2' X 2'. IF THE BUFFER AREA IS LESS THAN 4' THE LANDING AREA CROSS-SLOPE CANNOT EXCEED THE GRADE OF THE ROAD.

SPECIFICATION <b>603 &amp; 611</b>	CATEGORY CODE ITEMS
APPROVED	<i>[Signature]</i> DIRECTOR - OFFICE OF HIGHWAY DEVELOPMENT
	APPROVAL • SHA REVISIONS
	APPROVAL • FEDERAL HIGHWAY ADMINISTRATION
	APPROVAL 2-10-84
	APPROVAL 3-31-04
REVISION 8-25-88	REVISION 4-5-06
REVISION 6-2-14	REVISION 5-30-14
REVISION	REVISION

**Maryland Department of Transportation  
STATE HIGHWAY ADMINISTRATION**  
STANDARDS FOR HIGHWAYS AND INCIDENTAL STRUCTURES

**SIDEWALK RAMPS  
COMBINATION**

**STANDARD NO. MD 655.13**



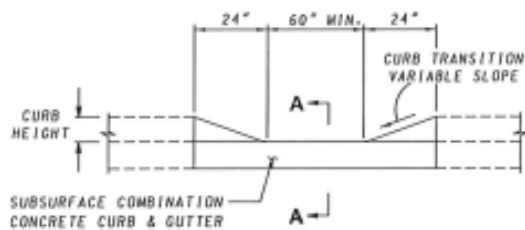
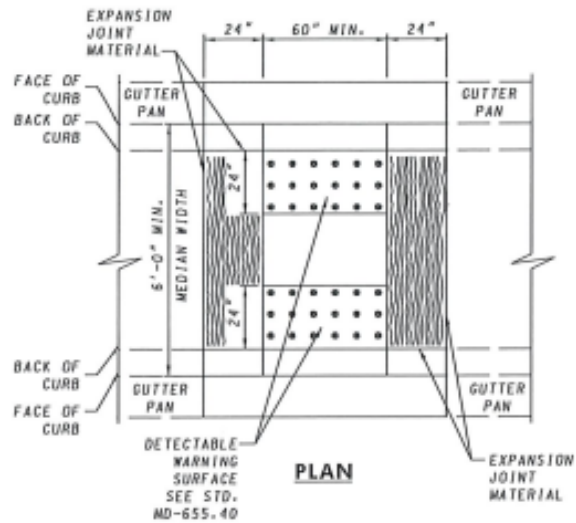

**ELEVATION**

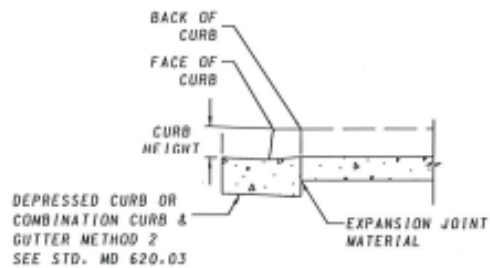

**SECTION A-A**

**NOTES**

1. TO BE USED WHERE A STREET-LEVEL PEDESTRIAN CROSSING IS REQUIRED THROUGH RAISED MEDIANS OR RAISED ISLANDS AND THERE IS INSUFFICIENT WIDTH TO PROVIDE A RAMPED MEDIAN OR ISLAND OPENING (STD. MD-655.22).
2. EXPANSION JOINT MATERIAL SHALL BE INSTALLED IN ACCORDANCE WITH STANDARD MD-655.01.
3. CUT-THROUGH MEDIAN AND ISLAND OPENINGS TO BE SHOWN ON PLANS SYMBOLICALLY AND REFERENCED WITH THE CENTER OF THE OPENING ALIGNED TO A STATION ON THE CONSTRUCTION CENTERLINE. SEPARATE DETAILS SHALL BE SHOWN WHERE PROPOSED OPENING VARIES FROM STANDARD METHODS.
4. WHERE 60° CUT THROUGHS CAN NOT BE PROVIDED A DESIGN WAIVER MUST BE REQUESTED.

SPECIFICATION <b>603 &amp; 611</b>	CATEGORY CODE ITEMS	<b>Maryland Department of Transportation</b> <b>STATE HIGHWAY ADMINISTRATION</b> STANDARDS FOR HIGHWAYS AND INCIDENTAL STRUCTURES  <b>CUT-THROUGH</b> <b>MEDIAN AND ISLAND OPENINGS</b>  <b>STANDARD NO. MD 655.21</b>	
APPROVED	 DIRECTOR - OFFICE OF HIGHWAY DEVELOPMENT		
	APPROVAL - SHA REVISIONS APPROVAL <b>2-18-04</b> REVISED <b>6-2-14</b> REVISED REVISED		

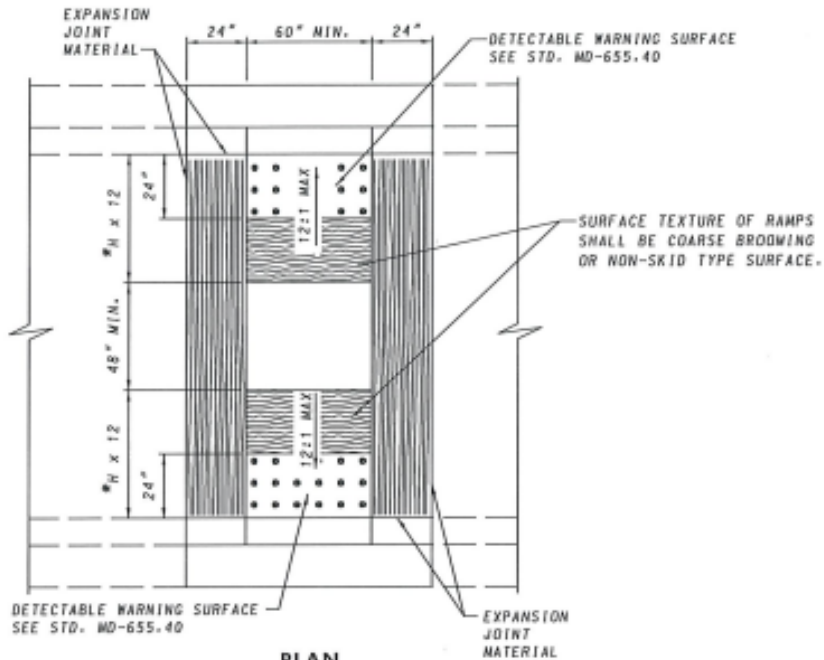

\* - H = HEIGHT OF CURB  
ALL MEASUREMENTS IN INCHES

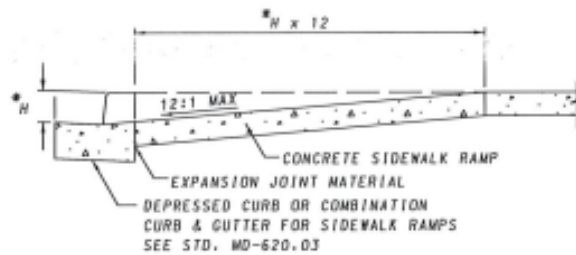
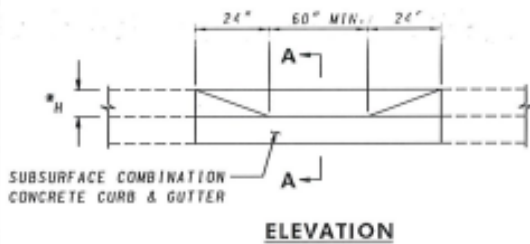

#### NOTES

1. TO BE USED WHERE A PEDESTRIAN ACCESS ROUTE CROSSES RAISED MEDIANS OR RAISED ISLANDS AND THERE IS SUFFICIENT WIDTH TO SATISFY THE GEOMETRY OUTLINED IN THIS STANDARD.
2. EXPANSION JOINT MATERIAL SHALL BE INSTALLED IN ACCORDANCE WITH STANDARD MD-655.01.
3. RAMPED MEDIAN AND ISLAND OPENINGS TO BE SHOWN ON PLANS SYMBOLICALLY AND REFERENCED WITH THE CENTER OF THE OPENING ALIGNED TO A STATION ON THE CONSTRUCTION CENTERLINE. SEPARATE DETAILS SHALL BE SHOWN WHERE PROPOSED OPENING VARIES FROM STANDARD METHODS.
4. WHERE 60" OPENINGS CAN NOT BE USED A DESIGN WAIVER MUST BE REQUESTED.

SPECIFICATION <b>603 &amp; 611</b>	CATEGORY CODE ITEMS	<b>Maryland Department of Transportation</b> <b>STATE HIGHWAY ADMINISTRATION</b> STANDARDS FOR HIGHWAYS AND INCIDENTAL STRUCTURES  <b>RAMPED</b> <b>MEDIAN AND ISLAND OPENINGS</b>	
APPROVED	DIRECTOR - OFFICE OF HIGHWAY DEVELOPMENT		
	APPROVAL - SHA REVISIONS	APPROVAL - FEDERAL HIGHWAY ADMINISTRATION	
	APPROVAL 2-10-04	APPROVAL 3-31-04	
	REVISED 4-2-14	REVISED 5-20-14	
	REVISED	REVISED	
STANDARD NO.		MD 655.22	

**MAT DETAILS**

SEE PLACEMENT GUIDELINES BELOW

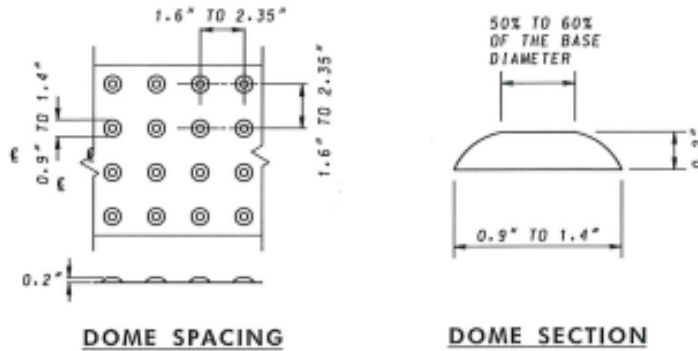

**PLACEMENT GUIDELINES**

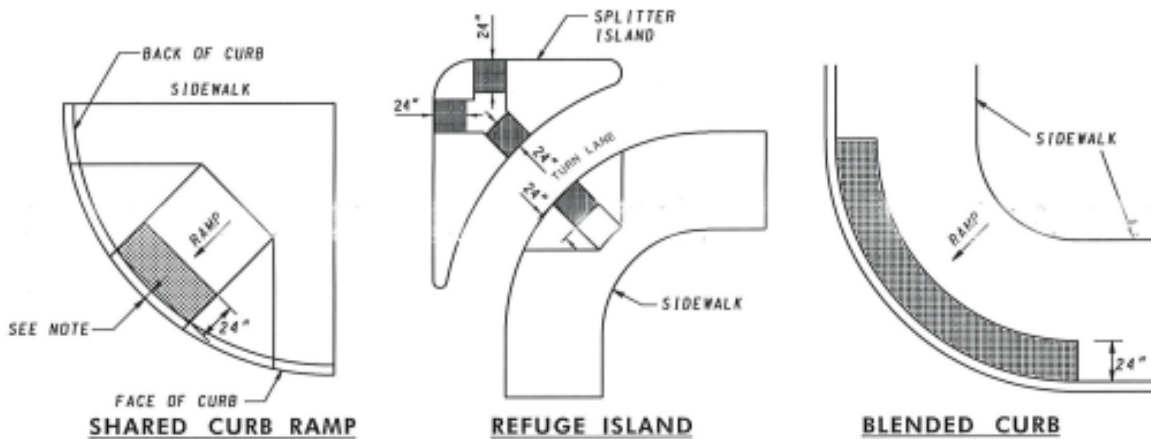

WHERE ISLANDS OR MEDIANS ARE LESS THAN 6 FEET WIDE, THE DETECTABLE WARNING SHOULD EXTEND ACROSS THE FULL LENGTH OF THE CUT THROUGH THE ISLAND OR MEDIAN

**NOTES**

1. THE DETECTABLE WARNING SURFACE SHALL BE LOCATED SO THAT THE EDGE NEAREST THE CURB LINE IS 6 TO 8 INCHES FROM THE FACE OF CURB.
2. FOR SKEWED APPLICATIONS DETECTABLE WARNING SHALL BE PLACED SUCH THAT THE DOMES CLOSEST TO THE BACK OF CURB ARE NO LESS THAN 0.5\"
3. DETECTABLE WARNING SURFACE SHALL BE PAID FOR IN ACCORDANCE WITH SECTION 611 OF THE SPECIFICATIONS.
4. DETECTABLE WARNING SURFACES ARE REQUIRED AT STREET CROSSING & SIGNALIZED INTERSECTIONS.

SPECIFICATION <b>611</b>	CATEGORY CODE ITEMS	<p><b>Maryland Department of Transportation</b>  <b>STATE HIGHWAY ADMINISTRATION</b>                  STANDARDS FOR HIGHWAYS AND INCIDENTAL STRUCTURES</p> <p><b>DETECTABLE WARNING SURFACES</b></p> <p><b>STANDARD NO. MD 655.40</b></p>	
APPROVED	DIRECTOR - OFFICE OF HIGHWAY DEVELOPMENT <i>[Signature]</i>		
	APPROVAL • SHA REVISIONS APPROVAL 2-18-04 REVISED 4-17-06 REVISED REVISED		APPROVAL • FEDERAL HIGHWAY ADMINISTRATION APPROVAL 3-31-04 REVISED 4-5-06 REVISED REVISED

Appendix E

Schedule of Improvements

Fiscal Year	Location	Condition	Description	Recommended Improvements	LF of Sidewalks	# of Curb Ramps	Estimated Cost	
FY25	Maugans Avenue at Greensfield Avenue	B1	No detectable warning surface.	Install detectable warning surface.		1	\$200	
FY25	Maugans Avenue at Seneca Ridge Drive	B1	No detectable warning surface.	Install detectable warning surface.		2	\$400	
FY25	Lexington Avenue at Lincoln Avenue / Scarlet Oak Drive	B1	No curb ramp. / No detectable warning surface.	Install curb ramp. Install detectable warning surface.		2	\$15,000	
FY25	Rockland Drive at Morning Walk Drive	B1	No detectable warning surface.	Install detectable warning surface.		4	\$800	
FY25	Rockland Drive at Westenberger Drive	B1	No detectable warning surface.	Install detectable warning surface.		2	\$400	
FY25	Rockland Drive at Coatbridge Lane	B1	No detectable warning surface.	Install detectable warning surface.		2	\$400	
FY25	Rockland Drive at Morning Dew Drive / Court	B1	No detectable warning surface.	Install detectable warning surface.		4	\$800	
FY25	Rockland Drive at Shetland Way	B1	No detectable warning surface.	Install detectable warning surface.		2	\$400	
FY25	Maugans Avenue (near Maugansville Elementary)	B2	No passing zones.	Install passing zones.	10		\$2,000	
FY25	Robinwood Drive	B2	No passing zones.	Install passing zones.	55		\$11,000	
FY25	Glenside Drive at Oak Ridge Drive	C1	No curb ramp.	Install curb ramp.		2	\$10,000	
FY25	Maugansville Road at Leona Avenue	C1	No detectable warning surface.	Install detectable warning surface.		2	\$400	
FY25	Maugans Avenue at Oliver Drive	C1	No detectable warning surface.	Install detectable warning surface.		1	\$200	
FY25	Dual Highway mid-block (between Cornell Avenue & Mount Aetna Road)	C1	No detectable warning surface.	Install detectable warning surface.		6	\$1,200	
FY25	Maugansville Road	C1	Missing and cracked sidewalk.	Install and replace sidewalk.	300		\$60,000	
FY26	Glenside Drive mid-block (between Virginia Avenue & Oak Ridge Drive)	C1	Missing and cracked sidewalk.	Install and replace sidewalk.	1850		\$400,000	
FY27	Longmeadow Road mid-block (between Highlane Street & Railroad)	D1	Missing and cracked sidewalk.	Install and replace sidewalk.	650		\$130,000	
FY28	Lincoln Avenue mid-block (between Virginia Avenue & Lexington Avenue)	D1	Missing and cracked sidewalk.	Install and replace sidewalk.	200		\$40,000	
FY28	Lincoln Avenue mid-block (between Virginia Avenue & Lexington Avenue)	D1	No curb ramp. / No detectable warning surface.	Install curb ramp. Install detectable warning surface.		4	\$40,000	
FY29	Glenside Drive mid-block (between Virginia Avenue & Oak Ridge Drive)	D1	No curb ramp.	Install curb ramp.		2	\$20,000	
FY29	Halfway Boulevard at I-81 Exit 5 (West of 81)	D1	No detectable warning surface.	Install detectable warning surface.		6	\$1,200	
FY29	Halfway Boulevard at I-81 Exit 5 (East of 81)	D1	No detectable warning surface.	Install detectable warning surface.		2	\$400	
FY29	Valley Mall Road at Valley Mall Access from Halfway Boulevard	D1	No curb ramp.	Install curb ramp.		2	\$10,000	
FY30	Village Mill at Leona Avenue	D1	No curb ramp.	Install curb ramp.		1	\$10,000	
FY30	Village Mill at Eby Lane	D1	No detectable warning surface.	Install detectable warning surface.		2	\$400	
FY30	Village Mill at Maugans Avenue	D1	No detectable warning surface.	Install detectable warning surface.		4	\$800	
FY30	Village Mill at Railroad Street	D1	No detectable warning surface.	Install detectable warning surface.		3	\$600	
FY30	Village Mill mid-block (between Railroad Street & Maugans Avenue)	D1	Missing and cracked sidewalk.	Install and replace sidewalk.	250		\$49,000	
FY30	Village Mill mid-block (between Maugans Avenue & Eby Lane)	D1	Missing and cracked sidewalk.	Install and replace sidewalk.	380		\$77,000	
FY30	Village Mill mid-block (between Eby Lane & Leona Avenue)	D1	Missing and cracked sidewalk.	Install and replace sidewalk.	540		\$108,000	
FY30	Village Mill mid-block (between Garden View Road & Railroad Street)	D1	Missing and cracked sidewalk.	Install and replace sidewalk.	745		\$149,000	
FY30	Village Mill at Garden View Road	D1	No curb ramp. / No detectable warning surface.	Install curb ramp. Install detectable warning surface.		4	\$20,000	
FY30	Village Mill mid-block (between Horst Lane & Garden View Road)	D1	Cracked sidewalk.	Repair Sidewalk	200		\$5,000	
FY30	Village Mill mid-block (between Horst Lane & Garden View Road)	D1	No curb ramp.	Install curb ramp.		1	\$10,000	
FY31	John F Kennedy Drive mid-block (between Robinwood Drive & Professional Boulevard)	D1	No detectable warning surface.	Install detectable warning surface.		14	\$2,800	
FY31	John F Kennedy Drive mid-block (between Robinwood Drive & Professional Boulevard)	D2	No passing zones.	Install passing zones.	25		\$5,000	
FY31	Funkstown Road at Hebb Road	E1	No detectable warning surface.	Install detectable warning surface.		1	\$200	
FY31	Funkstown Road mid-block	E1	Missing and cracked sidewalk.	Install and replace sidewalk.	40		\$8,000	
FY31	Colonial Drive mid-block (between Cornell & Birch Knoll Road)	E1	No curb ramp.	Install curb ramp.		8	\$40,000	
FY31	Colonial Drive at Birch Knoll Road	E1	No detectable warning surface.	Install detectable warning surface.		2	\$400	
FY31	Delwood Avenue at Gardenwood Drive	E1	No curb ramp.	Install curb ramp.		2	\$10,000	
FY32	Delwood Avenue	E1	Missing and cracked sidewalk.	Install and replace sidewalk.	600		\$120,000	
FY33	Delwood Avenue at Washington Street (MD-144)	E1	No curb ramp.	Install curb ramp.		2	\$10,000	
FY33	Fairway Lane at Sand Wedge Drive	E1	No curb ramp.	Install curb ramp.		2	\$10,000	
FY33	Fairway Lane at Par Three Drive	E1	No detectable warning surface.	Install detectable warning surface.		3	\$600	
FY33	Fairway Lane at Putter Drive	E1	No detectable warning surface.	Install detectable warning surface.		3	\$600	
FY33	Fairway Lane at Clubhouse Drive	E1	No detectable warning surface.	Install detectable warning surface.		1	\$200	
FY33	Fairway Lane mid-block (between Clubhouse Drive & Downsville Pike)	E1	Missing and cracked sidewalk.	Install and replace sidewalk.	20		\$4,000	
FY33	Honeyfield Road	E1	Missing and cracked sidewalk.	Install and replace sidewalk.	250		\$50,000	
FY34	Sturgis Drive at Hebb Road	E1	No curb ramp.	Install curb ramp.		1	\$5,000	
FY34	Sturgis Drive mid-block	E1	Cracked sidewalk.	Replace sidewalk.	370		\$75,000	
FY34	Iroquois Drive	E1	Missing and cracked sidewalk.	Install and replace sidewalk.	75		\$15,000	
FY34	Navaho Circle	E1	Cracked sidewalk.	Replace sidewalk.	20		\$4,000	
FY35	Distant View Drive	E1	Missing and cracked sidewalk.	Install and replace sidewalk.	225		\$45,000	
FY35	Distant View Drive at Alpine Drive	E1	No curb ramp.	Install curb ramp.		1	\$5,000	
FY35	Shelby Circle at Reiff Church Road	E1	No detectable warning surface.	Install detectable warning surface.		2	\$400	
FY35	Sunflower Drive (Intersection with South Pointe Drive to cul-de-sac)	E1	No detectable warning surface.	Install detectable warning surface.		4	\$800	
FY35	Buttercup Drive (Intersection with South Pointe Drive to cul-de-sac)	E1	No detectable warning surface.	Install detectable warning surface.		4	\$800	
FY35	Southern Oak Drive (Intersection with South Pointe Drive to cul-de-sac)	E1	No detectable warning surface.	Install detectable warning surface.		4	\$800	
FY35	South Pointe Drive at South Fork Drive	E1	No detectable warning surface.	Install detectable warning surface.		2	\$400	
FY35	South Fork Drive at Winding Oak Drive	E1	No detectable warning surface.	Install detectable warning surface.		1	\$200	
FY35	South Pointe Drive at Winding Oak Drive (North & South intersections)	E1	No detectable warning surface.	Install detectable warning surface.		6	\$1,200	
FY35	Winding Oak at Villa Ridge Drive	E1	No detectable warning surface.	Install detectable warning surface.		2	\$400	
FY35	Hunters Woods Drive at cul-de-sac	E1	No detectable warning surface.	Install detectable warning surface.		2	\$400	
FY36	Greenmount Avenue mid-block (between Lexington Avenue & York Road)	E1	Missing and cracked sidewalk.	Install and replace sidewalk.	250		\$50,000	
FY36	Greenmount Avenue at Wolford Avenue	E1	No curb ramp.	Install curb ramp.		1	\$5,000	
FY36	Lincoln Avenue at Gay Street	E1	No detectable warning surface.	Install detectable warning surface.		1	\$200	
FY37	Roessner Avenue mid-block (between Virginia Avenue & Gay Street)	E1	Missing and cracked sidewalk.	Install and replace sidewalk.	520		\$104,000	
FY38	Lincoln Avenue mid-block (between Lincolnshire Road & Gay Street)	E1	Missing and cracked sidewalk.	Install and replace sidewalk.	260		\$52,000	
FY38	Roessner Avenue mid-block (at unnamed alley)	E1	No curb ramp.	Install curb ramp.		3	\$15,000	
FY38	Gay Street mid-block (between Coffman Avenue & Allen Avenue)	E1	Missing and cracked sidewalk.	Install and replace sidewalk.	30		\$6,000	
FY38	Coffman Avenue mid-block (between Virginia Avenue & Gay Street)	E1	Missing and cracked sidewalk.	Install and replace sidewalk.	25		\$5,000	
FY38	Pin Oak Road at Hickory Lane	E1	No detectable warning surface.	Install detectable warning surface.		2	\$400	
FY40	Morning Walk Drive at Morning Dew Drive	E1	No detectable warning surface.	Install detectable warning surface.		2	\$400	
FY40	Morning Walk Drive at Misty Field Lane	E1	No detectable warning surface.	Install detectable warning surface.		2	\$400	
FY40	Morning Walk Drive at Berwick Terrace	E1	No detectable warning surface.	Install detectable warning surface.		1	\$200	
FY40	Morning Walk Drive at Misty Acres Drive	E1	No detectable warning surface.	Install detectable warning surface.		1	\$200	
FY40	Coatbridge Lane at Misty Acres Drive	E1	No detectable warning surface.	Install detectable warning surface.		3	\$600	
FY40	Highlane Street mid-block (between Smallwood Terrace & Longmeadow Road)	E2	Running Slope too steep.	Replace or repair sidewalk.	40		\$8,000	
FY40	Sweet Vale Drive mid-block (between Mesa Terrace & Wavy Hill Avenue)	E2	Cross Slope too steep.	Replace or repair sidewalk.			\$60,000	
					TOTAL	7221	144	\$1,898,200
					Miles	1.37		

# Broadfording Road

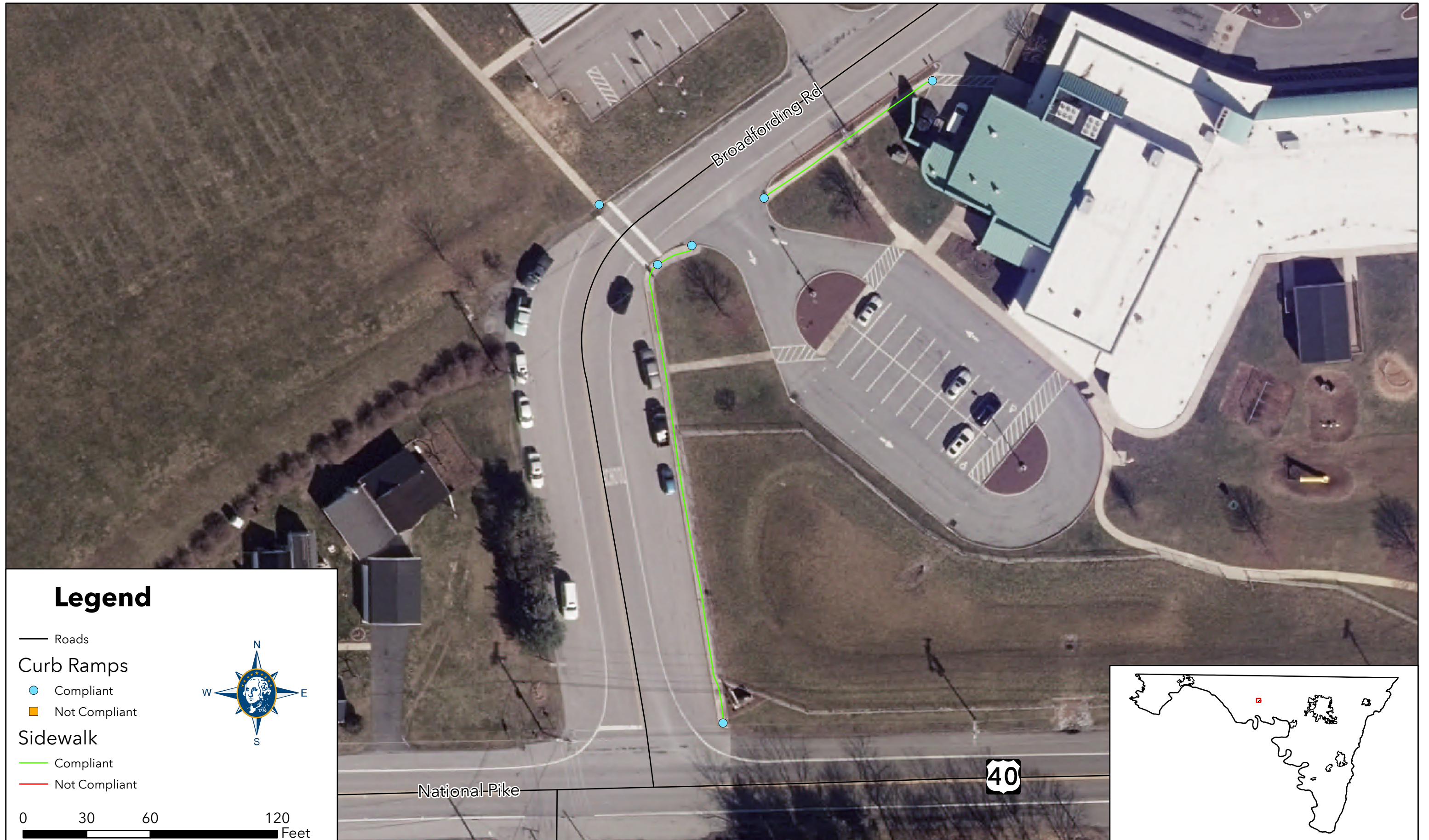

# Crayton Boulevard - Perini Avenue



# Delwood Avenue



## Legend

— Roads

### Curb Ramps

- Compliant
- Not Compliant

### Sidewalk

- Compliant
- Not Compliant



0 75 150 300 Feet

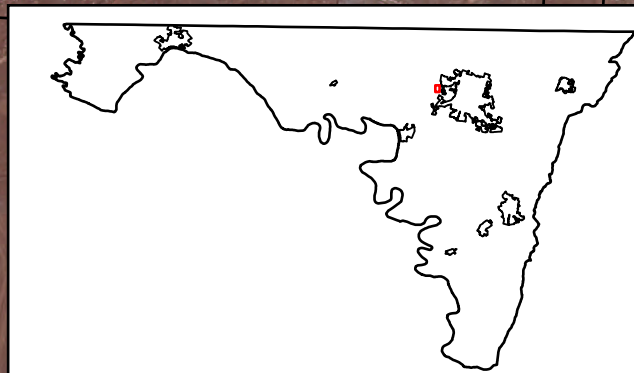

# Dual Highway Area

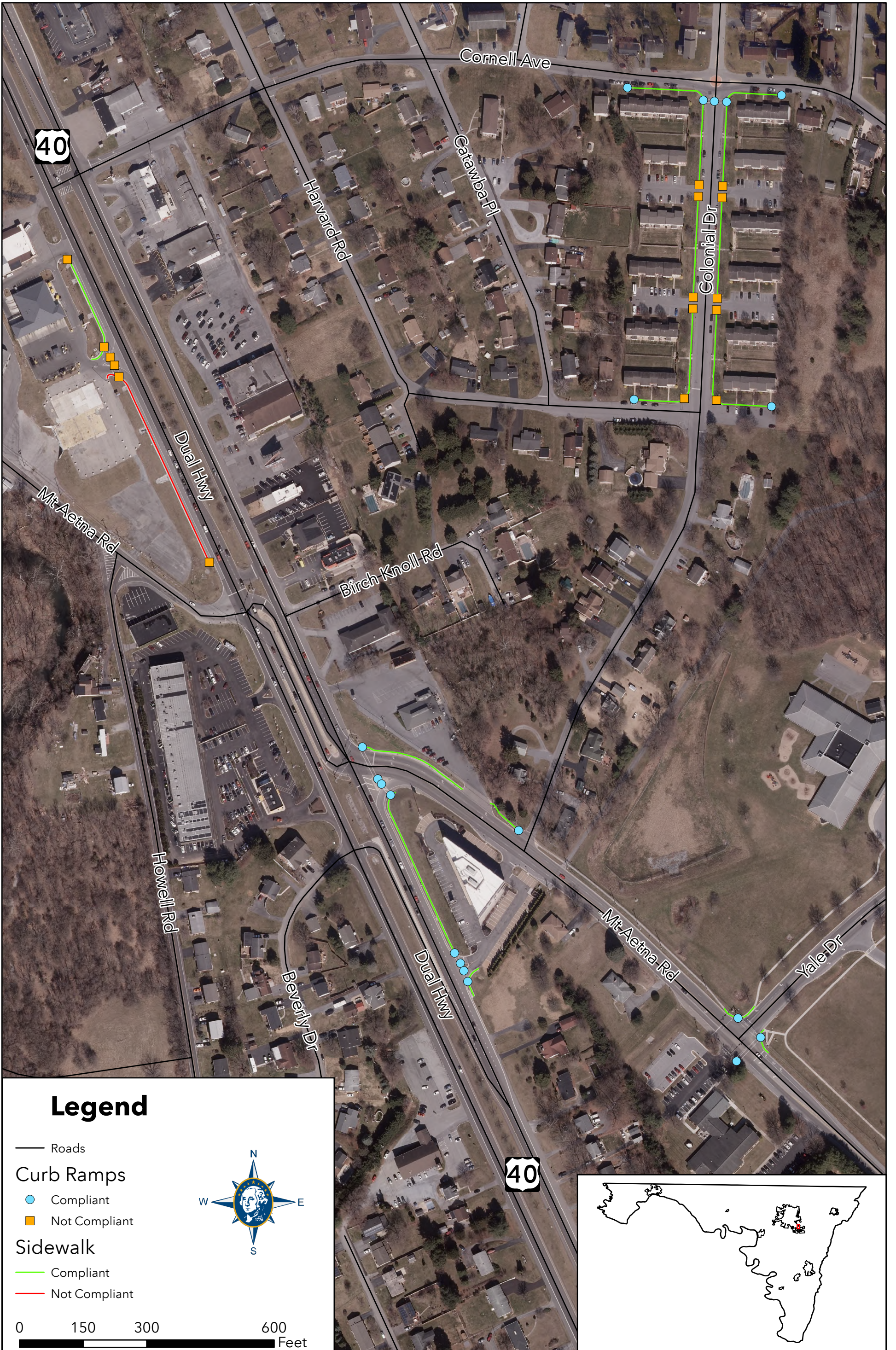



# Edgewood Drive - Robinwood Drive



# Fairway Lane Area



## Legend

— Roads

### Curb Ramps

● Compliant

■ Not Compliant

### Sidewalk

— Compliant

— Not Compliant

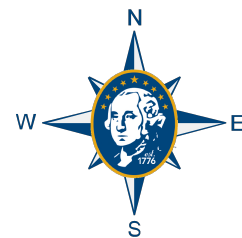

0 115 230 460 Feet

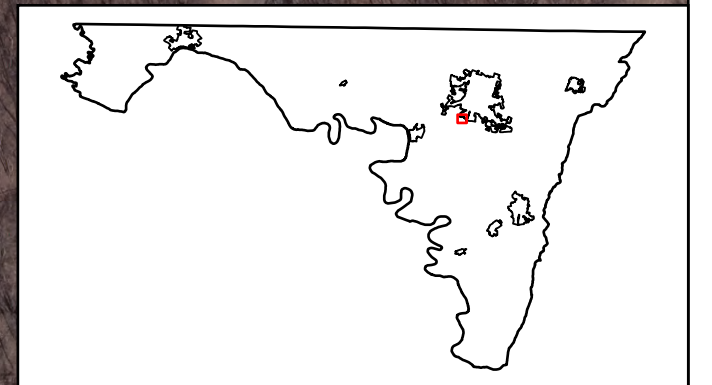

# Glenside Avenue



# Halfway Boulevard - Stotler Road



# Halfway Boulevard - Underpass Way



# Hebb Road Area



# Honeyfield Road



# Iroquois Avenue Area





# John F Kennedy Drive - Professional Boulevard



# Linwood Road



## Legend

- Roads
- Curb Ramps**
  - Compliant
  - Not Compliant
- Sidewalk**
  - Compliant
  - Not Compliant

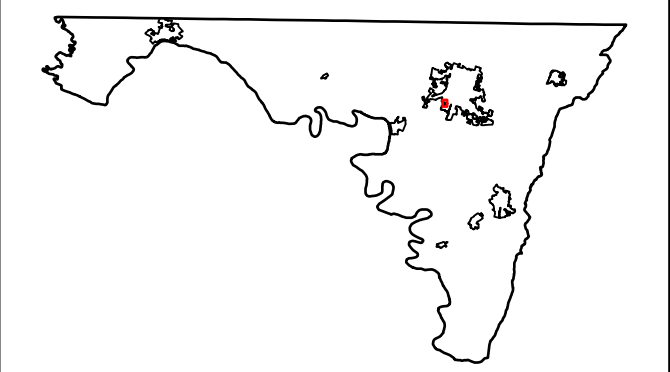
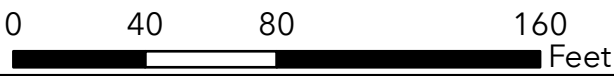
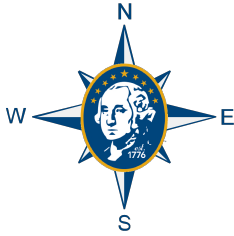

# Marsh Pike / Longmeadow Road Area



# Massey Boulevard



# Maugans Avenue



# Maugans Avenue - Longmeadow Road

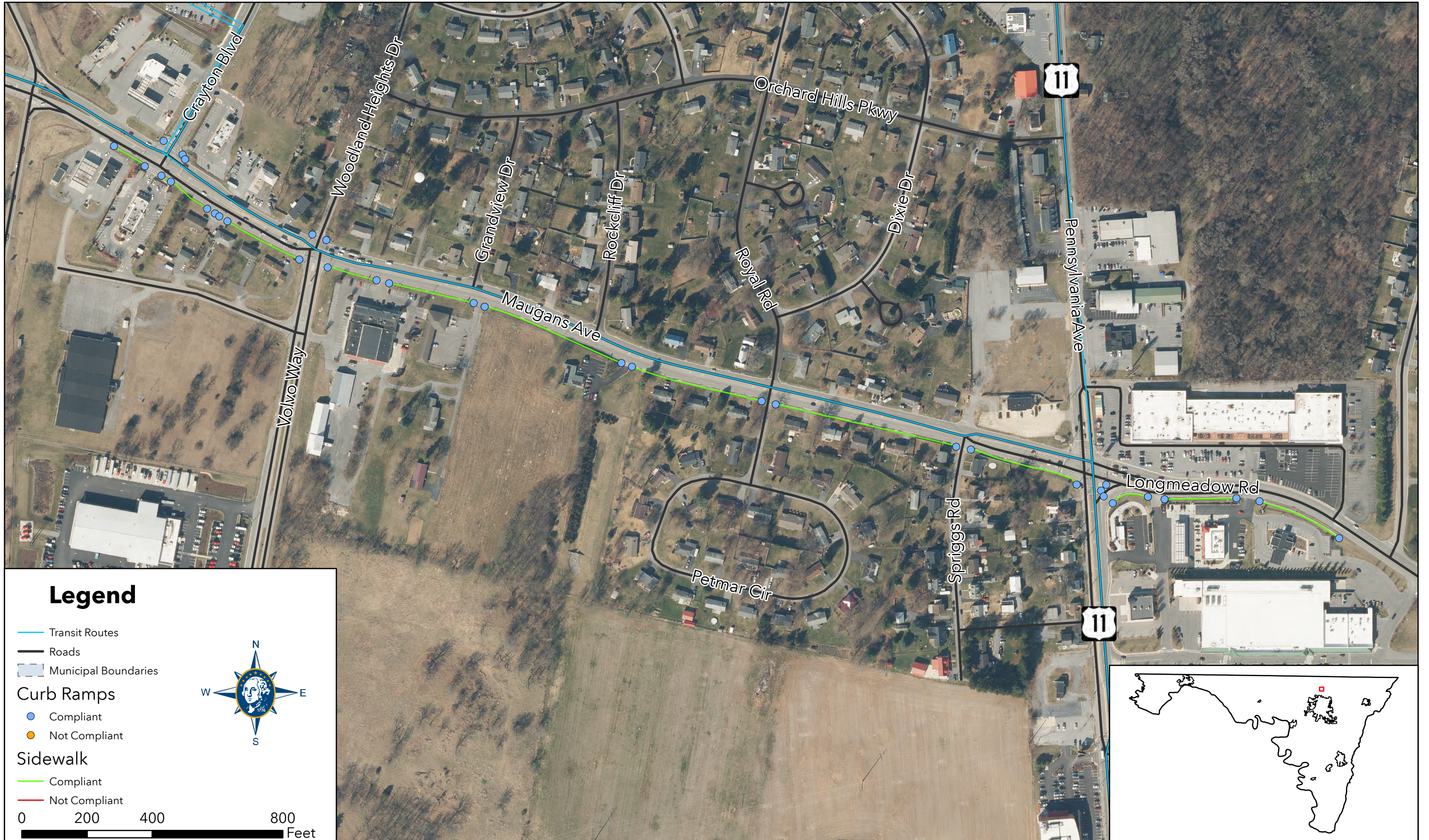

# Northern Avenue

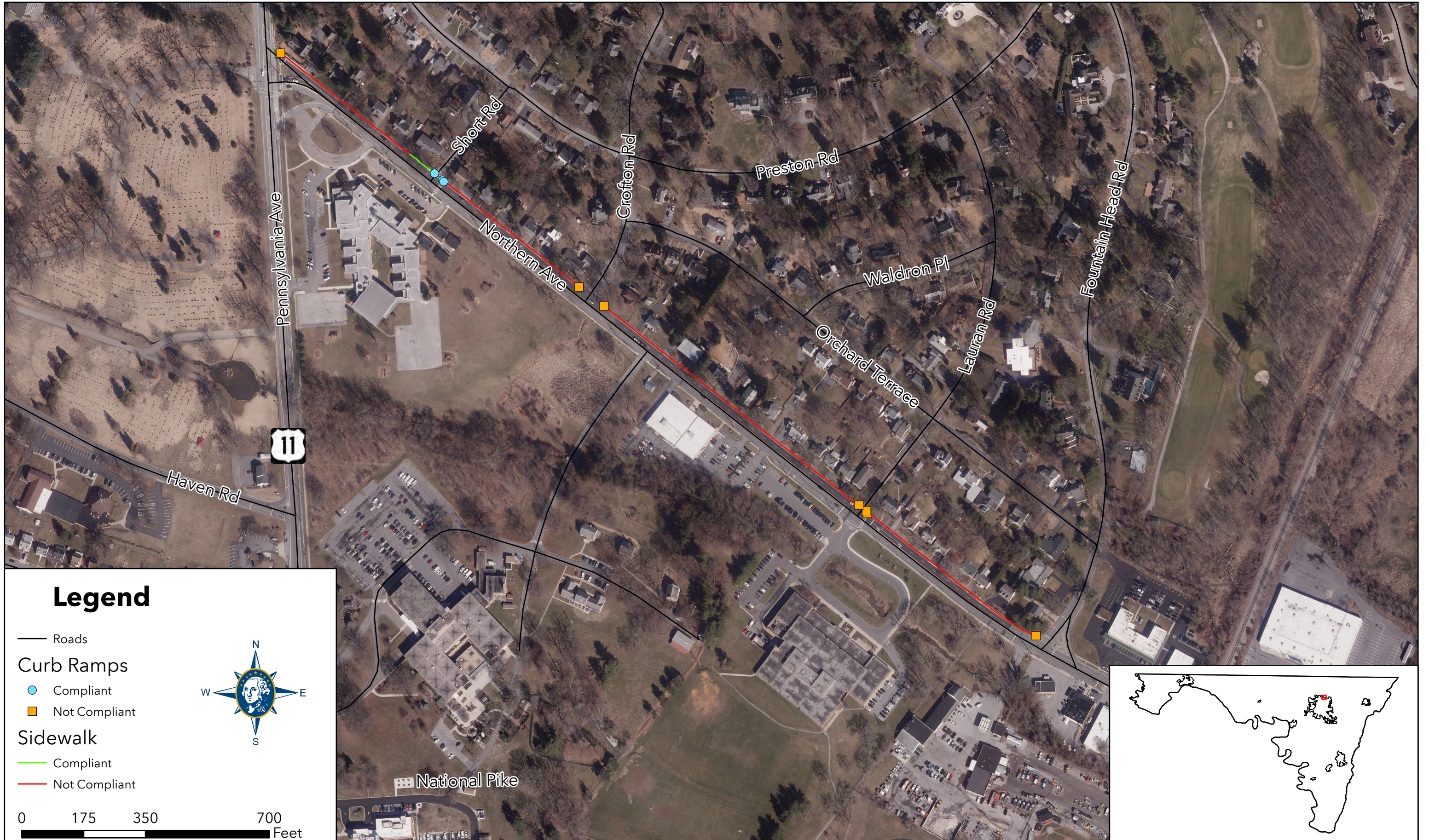

# Oak Hill Avenue



## Legend

- Roads
- Curb Ramps**
  - Compliant
  - Not Compliant
- Sidewalk**
  - Compliant
  - Not Compliant

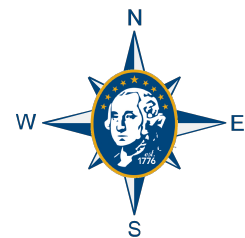

0 45 90 180 Feet

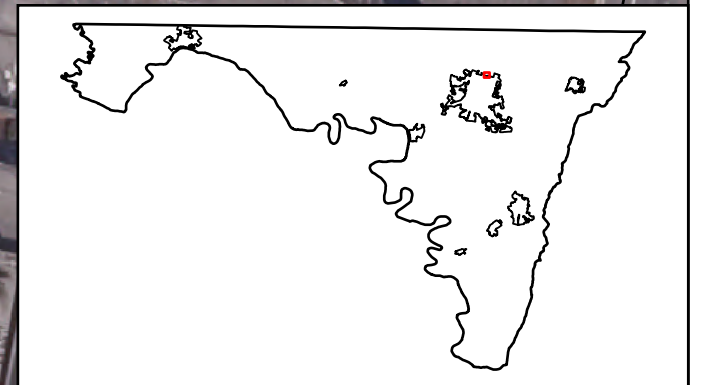



# Oak Valley Drive - Halfway Boulevard



# Pin Oak Road



# Robinwood Drive - Academic Boulevard



# Sharpsburg Pike Area



# Shelby Circle / Distant View Drive



# South Pointe Area - Southern Boulevard



# Sweet Vale Drive



# Virginia Avenue Area





# Westfields Area



# Yale Drive - Medical Campus Road



# Yale Drive - Professional Boulevard



Appendix E

Schedule of Improvements

Fiscal Year	Location	Condition	Description	Recommended Improvements	LF of Sidewalks	# of Curb Ramps	Estimated Cost	
FY25	Maugans Avenue at Greensfield Avenue	B1	No detectable warning surface.	Install detectable warning surface.		1	\$200	
FY25	Maugans Avenue at Seneca Ridge Drive	B1	No detectable warning surface.	Install detectable warning surface.		2	\$400	
		B1	No curb ramp. / No detectable warning surface.	Install curb ramp. Install detectable warning surface.		2	\$15,000	
FY25	Lexington Avenue at Lincoln Avenue / Scarlet Oak Drive	B1	No detectable warning surface.	Install detectable warning surface.		4	\$800	
FY25	Rockland Drive at Morning Walk Drive	B1	No detectable warning surface.	Install detectable warning surface.		2	\$400	
FY25	Rockland Drive at Westenberger Drive	B1	No detectable warning surface.	Install detectable warning surface.		2	\$400	
FY25	Rockland Drive at Coatbridge Lane	B1	No detectable warning surface.	Install detectable warning surface.		2	\$400	
FY25	Rockland Drive at Morning Dew Drive / Court	B1	No detectable warning surface.	Install detectable warning surface.		4	\$800	
FY25	Rockland Drive at Shetland Way	B1	No detectable warning surface.	Install detectable warning surface.		2	\$400	
FY25	Maugans Avenue (near Maugansville Elementary)	B2	No passing zones.	Install passing zones.	10		\$2,000	
FY25	Robinwood Drive	B2	No passing zones.	Install passing zones.	55		\$11,000	
FY25	Glenside Drive at Oak Ridge Drive	C1	No curb ramp.	Install curb ramp.		2	\$10,000	
FY25	Maugansville Road at Leona Avenue	C1	No detectable warning surface.	Install detectable warning surface.		2	\$400	
FY25	Maugans Avenue at Oliver Drive	C1	No detectable warning surface.	Install detectable warning surface.		1	\$200	
FY25	Dual Highway mid-block (between Cornell Avenue & Mount Aetna Road)	C1	No detectable warning surface.	Install detectable warning surface.		6	\$1,200	
FY25	Maugansville Road	C1	Missing and cracked sidewalk.	Install and replace sidewalk.	300		\$60,000	
FY26	Glenside Drive mid-block (between Virginia Avenue & Oak Ridge Drive)	C1	Missing and cracked sidewalk.	Install and replace sidewalk.	1850		\$400,000	
FY28	Lincoln Avenue mid-block (between Virginia Avenue & Lexington Avenue)	D1	Missing and cracked sidewalk.	Install and replace sidewalk.	200		\$40,000	
		D1	No curb ramp. / No detectable warning surface.	Install curb ramp. Install detectable warning surface.		4	\$40,000	
FY28	Lincoln Avenue mid-block (between Virginia Avenue & Lexington Avenue)	D1	No curb ramp.	Install curb ramp.		2	\$20,000	
FY29	Glenside Drive mid-block (between Virginia Avenue & Oak Ridge Drive)	D1	No detectable warning surface.	Install detectable warning surface.		2	\$20,000	
FY29	Halfway Boulevard at I-81 Exit 5 (West of 81)	D1	No detectable warning surface.	Install detectable warning surface.		6	\$1,200	
FY29	Halfway Boulevard at I-81 Exit 5 (East of 81)	D1	No detectable warning surface.	Install detectable warning surface.		2	\$400	
FY29	Valley Mall Road at Valley Mall Access from Halfway Boulevard	D1	No curb ramp.	Install curb ramp.		2	\$10,000	
FY27	Longmeadow Road mid-block (between Highlane Street & Railroad)	D1	Missing and cracked sidewalk.	Install and replace sidewalk.	650		\$130,000	
FY30	Village Mill at Leona Avenue	D1	No curb ramp.	Install curb ramp.		1	\$10,000	
FY30	Village Mill at Eby Lane	D1	No detectable warning surface.	Install detectable warning surface.		2	\$400	
FY30	Village Mill at Maugans Avenue	D1	No detectable warning surface.	Install detectable warning surface.		4	\$800	
FY30	Village Mill at Railroad Street	D1	No detectable warning surface.	Install detectable warning surface.		3	\$600	
FY30	Village Mill mid-block (between Railroad Street & Maugans Avenue)	D1	Missing and cracked sidewalk.	Install and replace sidewalk.	250		\$49,000	
FY30	Village Mill mid-block (between Maugans Avenue & Eby Lane)	D1	Missing and cracked sidewalk.	Install and replace sidewalk.	380		\$77,000	
FY30	Village Mill mid-block (between Eby Lane & Leona Avenue)	D1	Missing and cracked sidewalk.	Install and replace sidewalk.	540		\$108,000	
FY30	Village Mill mid-block (between Garden View Road & Railroad Street)	D1	Missing and cracked sidewalk.	Install and replace sidewalk.	745		\$149,000	
		D1	No curb ramp. / No detectable warning surface.	Install curb ramp. Install detectable warning surface.		4	\$20,000	
FY30	Village Mill at Garden View Road	D1	Cracked sidewalk.	Repair Sidewalk	200		\$5,000	
FY30	Village Mill mid-block (between Horst Lane & Garden View Road)	D1	No curb ramp.	Install curb ramp.		1	\$10,000	
FY31	John F Kennedy Drive mid-block (between Robinwood Drive & Professional Boulevard)	D1	No detectable warning surface.	Install detectable warning surface.		14	\$2,800	
FY31	John F Kennedy Drive mid-block (between Robinwood Drive & Professional Boulevard)	D2	No passing zones.	Install passing zones.	25		\$5,000	
FY31	Funkstown Road at Hebb Road	E1	No detectable warning surface.	Install detectable warning surface.		1	\$200	
FY31	Funkstown Road mid-block	E1	Missing and cracked sidewalk.	Install and replace sidewalk.	40		\$8,000	
FY31	Colonial Drive mid-block (between Cornell & Birch Knoll Road)	E1	No curb ramp.	Install curb ramp.		8	\$40,000	
FY31	Colonial Drive at Birch Knoll Road	E1	No detectable warning surface.	Install detectable warning surface.		2	\$400	
FY31	Delwood Avenue at Gardenwood Drive	E1	No curb ramp.	No curb ramp.		2	\$10,000	
FY32	Delwood Avenue	E1	Missing and cracked sidewalk.	Install and replace sidewalk.	600		\$120,000	
FY33	Delwood Avenue at Washington Street (MD-144)	E1	No curb ramp.	Install curb ramp.		2	\$10,000	
FY33	Fairway Lane at Sand Wedge Drive	E1	No curb ramp.	Install curb ramp.		2	\$10,000	
FY33	Fairway Lane at Par Three Drive	E1	No detectable warning surface.	Install detectable warning surface.		3	\$600	
FY33	Fairway Lane at Putter Drive	E1	No detectable warning surface.	Install detectable warning surface.		3	\$600	
FY33	Fairway Lane at Clubhouse Drive	E1	No detectable warning surface.	Install detectable warning surface.		1	\$200	
FY33	Fairway Lane mid-block (between Clubhouse Drive & Downsville Pike)	E1	Missing and cracked sidewalk.	Install and replace sidewalk.	20		\$4,000	
FY33	Honeyfield Road	E1	Missing and cracked sidewalk.	Install and replace sidewalk.	250		\$50,000	
FY34	Sturgis Drive at Hebb Road	E1	No curb ramp.	Install curb ramp.		1	\$5,000	
FY34	Sturgis Drive mid-block	E1	Cracked sidewalk.	Replace sidewalk.	370		\$75,000	
FY34	Iroquois Drive	E1	Missing and cracked sidewalk.	Install and replace sidewalk.	75		\$15,000	
FY34	Navaho Circle	E1	Cracked sidewalk.	Replace sidewalk.	20		\$4,000	
FY35	Distant View Drive	E1	Missing and cracked sidewalk.	Install and replace sidewalk.	225		\$45,000	
FY35	Distant View Drive at Alpine Drive	E1	No curb ramp.	Install curb ramp.		1	\$5,000	
FY35	Shelby Circle at Reiff Church Road	E1	No detectable warning surface.	Install detectable warning surface.		2	\$400	
FY35	Sunflower Drive (Intersection with South Pointe Drive to cul-de-sac)	E1	No detectable warning surface.	Install detectable warning surface.		4	\$800	
FY35	Buttercup Drive (Intersection with South Pointe Drive to cul-de-sac)	E1	No detectable warning surface.	Install detectable warning surface.		4	\$800	
FY35	Southern Oak Drive (Intersection with South Pointe Drive to cul-de-sac)	E1	No detectable warning surface.	Install detectable warning surface.		4	\$800	
FY35	South Pointe Drive at South Fork Drive	E1	No detectable warning surface.	Install detectable warning surface.		2	\$400	
FY35	South Fork Drive at Winding Oak Drive	E1	No detectable warning surface.	Install detectable warning surface.		1	\$200	
FY35	South Pointe Drive at Winding Oak Drive (North & South intersections)	E1	No detectable warning surface.	Install detectable warning surface.		6	\$1,200	
FY35	Winding Oak at Villa Ridge Drive	E1	No detectable warning surface.	Install detectable warning surface.		2	\$400	
FY35	Hunters Woods Drive at cul-de-sac	E1	No detectable warning surface.	Install detectable warning surface.		2	\$400	
FY36	Greenmount Avenue mid-block (between Lexington Avenue & York Road)	E1	Missing and cracked sidewalk.	Install and replace sidewalk.	250		\$50,000	
FY36	Greenmount Avenue at Wolford Avenue	E1	No curb ramp.	Install curb ramp.		1	\$5,000	
FY36	Lincoln Avenue at Gay Street	E1	No detectable warning surface.	Install detectable warning surface.		1	\$200	
FY37	Roessner Avenue mid-block (between Virginia Avenue & Gay Street)	E1	Missing and cracked sidewalk.	Install and replace sidewalk.	520		\$104,000	
FY38	Lincoln Avenue mid-block (between Lincolnshire Road & Gay Street)	E1	Missing and cracked sidewalk.	Install and replace sidewalk.	260		\$52,000	
FY38	Roessner Avenue mid-block (at unnamed alley)	E1	No curb ramp.	Install curb ramp.		3	\$15,000	
FY38	Gay Street mid-block (between Coffman Avenue & Allen Avenue)	E1	Missing and cracked sidewalk.	Install and replace sidewalk.	30		\$6,000	
FY38	Coffman Avenue mid-block (between Virginia Avenue & Gay Street)	E1	Missing and cracked sidewalk.	Install and replace sidewalk.	25		\$5,000	
FY38	Pin Oak Road at Hickory Lane	E1	No detectable warning surface.	Install detectable warning surface.		2	\$400	
FY40	Morning Walk Drive at Morning Dew Drive	E1	No detectable warning surface.	Install detectable warning surface.		2	\$400	
FY40	Morning Walk Drive at Misty Field Lane	E1	No detectable warning surface.	Install detectable warning surface.		2	\$400	
FY40	Morning Walk Drive at Berwick Terrace	E1	No detectable warning surface.	Install detectable warning surface.		1	\$200	
FY40	Morning Walk Drive at Misty Acres Drive	E1	No detectable warning surface.	Install detectable warning surface.		1	\$200	
FY40	Coatbridge Lane at Misty Acres Drive	E1	No detectable warning surface.	Install detectable warning surface.		3	\$600	
FY40	Highlane Street mid-block (between Smallwood Terrace & Longmeadow Road)	E2	Running Slope too steep.	Replace or repair sidewalk.	40		\$8,000	
FY40	Sweet Vale Drive mid-block (between Mesa Terrace & Wavy Hill Avenue)	E2	Cross Slope too steep.	Replace or repair sidewalk.			\$60,000	
					TOTAL	7221	144	\$1,898,200
					Miles	1.37		

# Broadfording Road

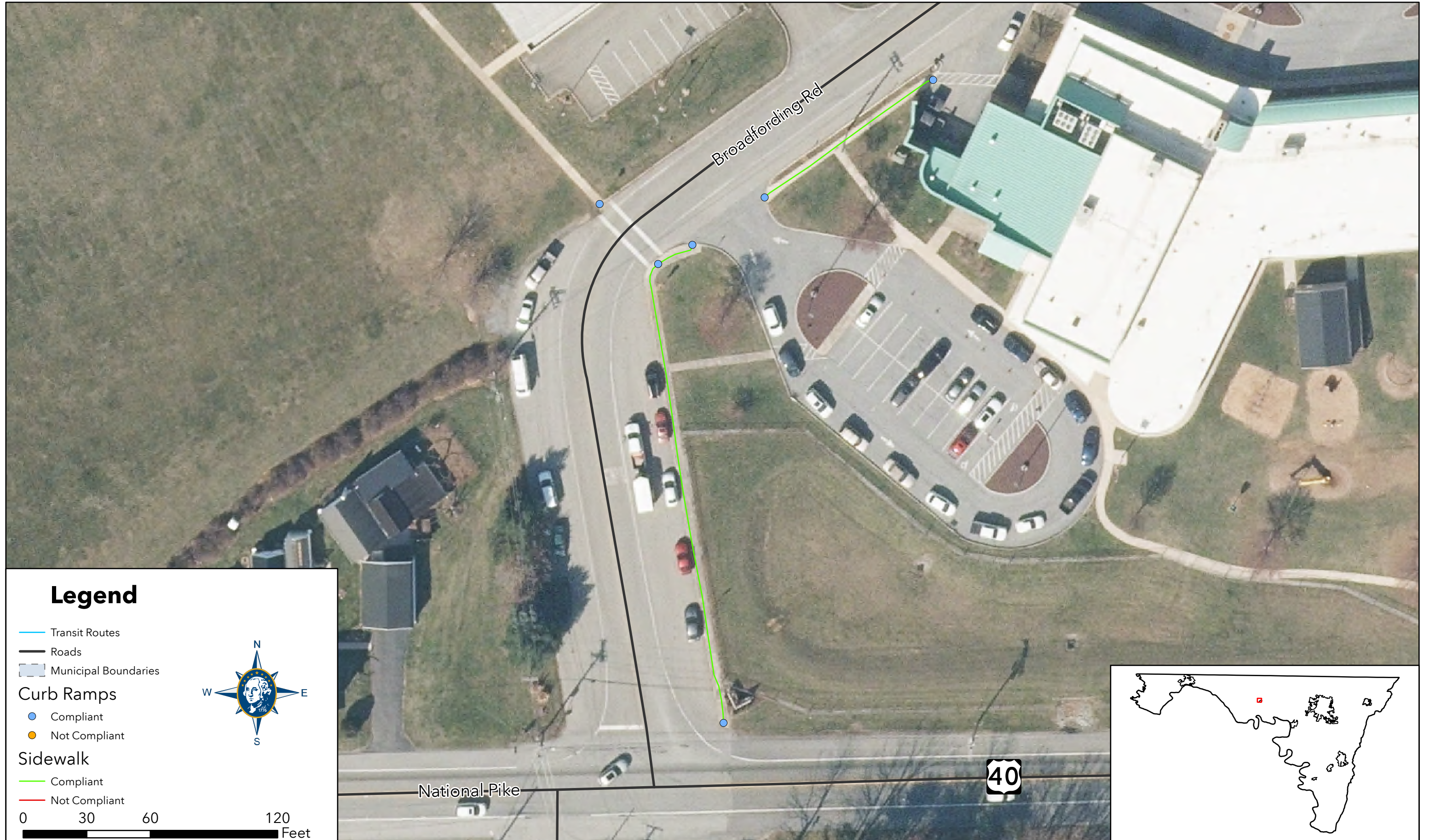

# Colonial Drive



# Crayton Boulevard - Perini Avenue



# Delwood Avenue



## Legend

- Transit Routes
- Roads
- ▭ Municipal Boundaries

### Curb Ramps

- Compliant
- Not Compliant

### Sidewalk

- Compliant
- Not Compliant

0 75 150 300 Feet

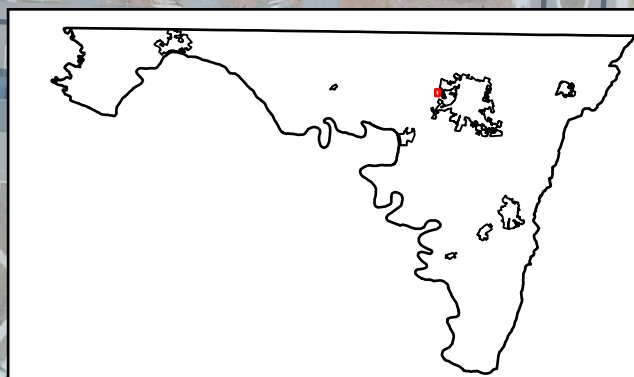
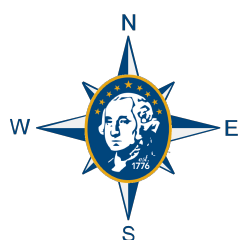



# Dual Highway Area

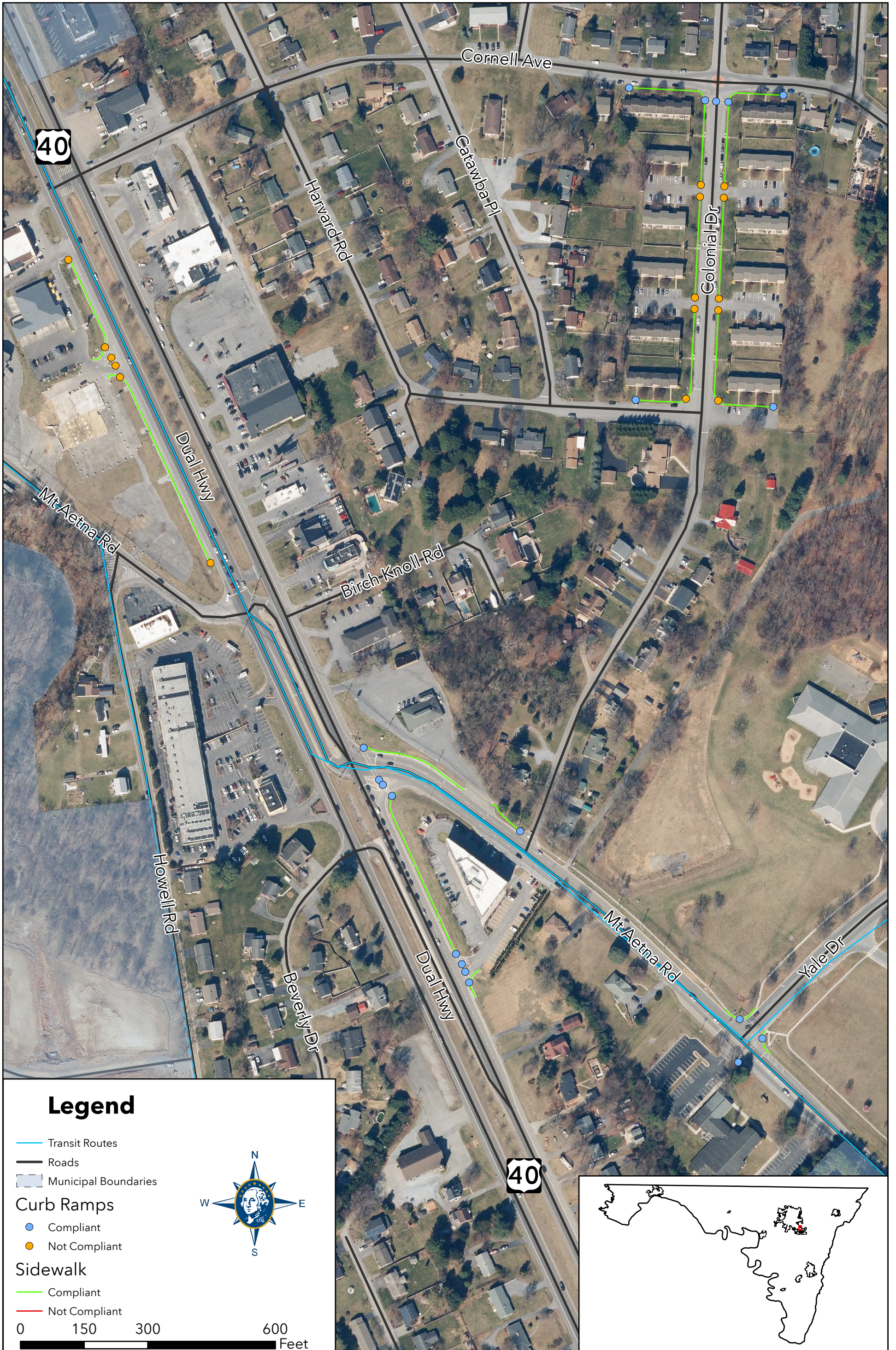

# Edgewood Drive - Robinwood Drive



# Fairway Lane Area

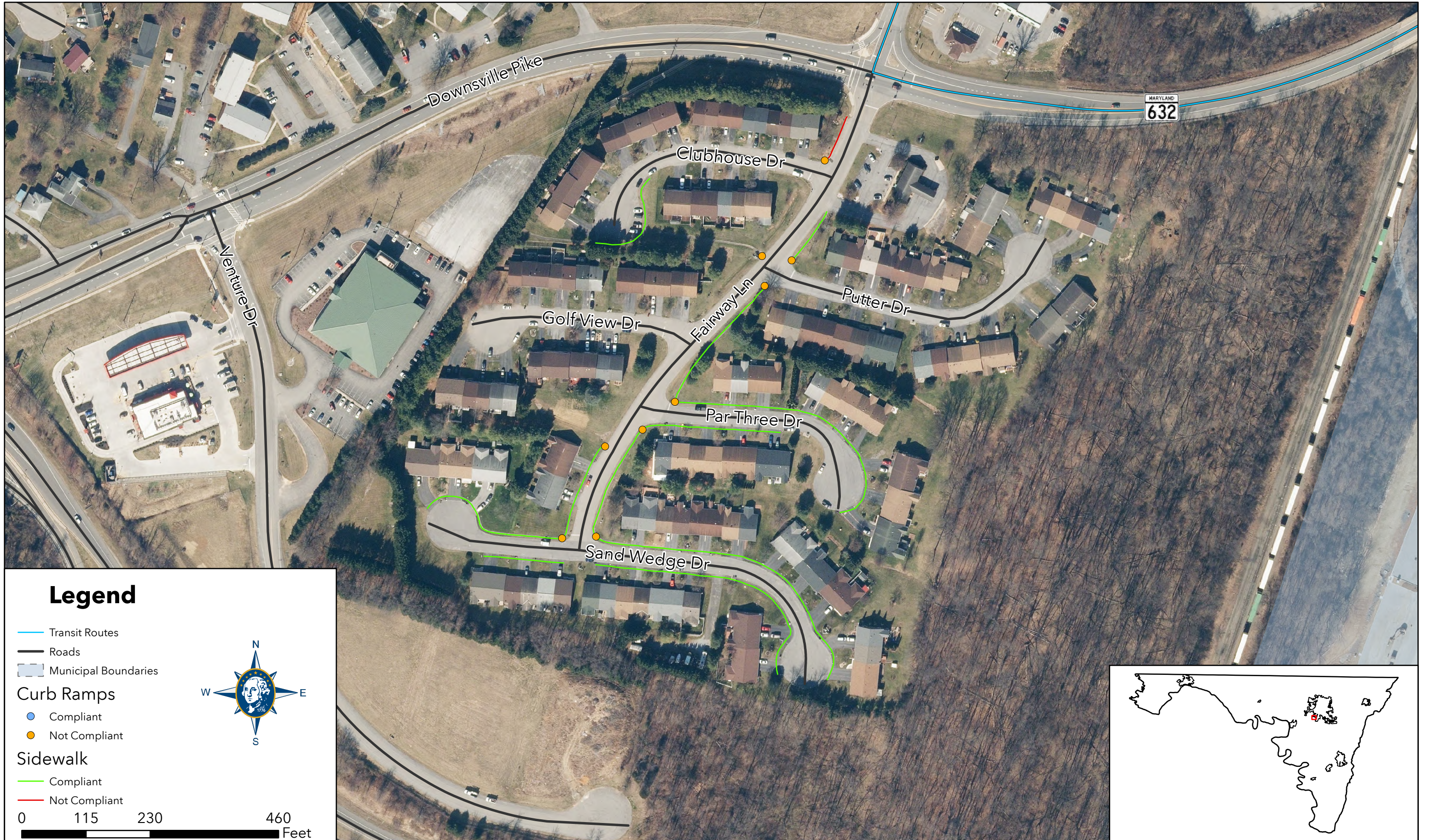

# Glenside Avenue



# Halfway Boulevard - Stotler Road



# Halfway Boulevard - Underpass Way

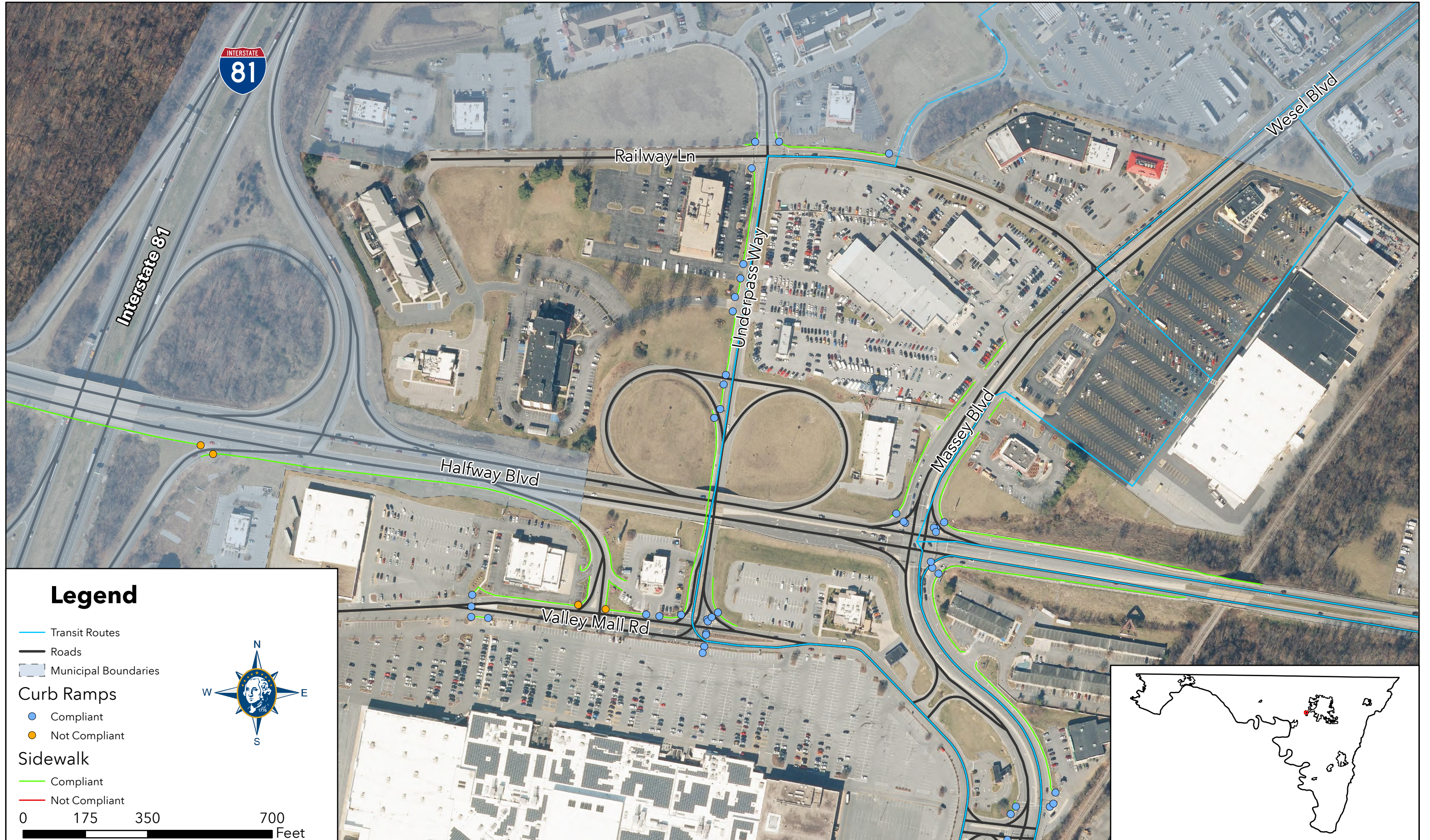

# Hebb Road Area



# Honeyfield Road

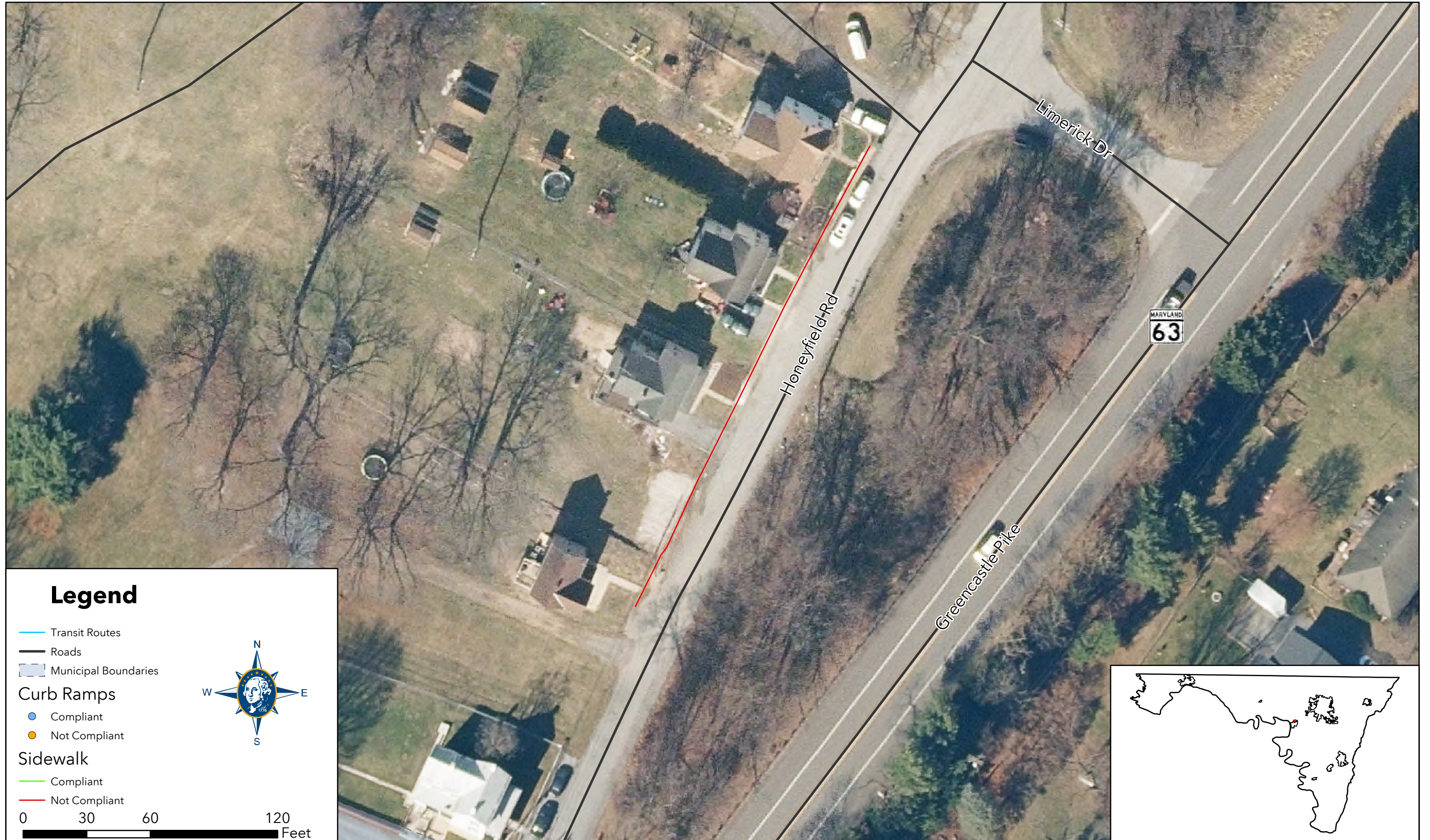



# Iroquois Avenue Area



# John F Kennedy Drive - Professional Boulevard



# Linwood Road



## Legend

- Transit Routes
- Roads
- Municipal Boundaries
- Curb Ramps**
  - Compliant
  - Not Compliant
- Sidewalk**
  - Compliant
  - Not Compliant



0 40 80 160 Feet

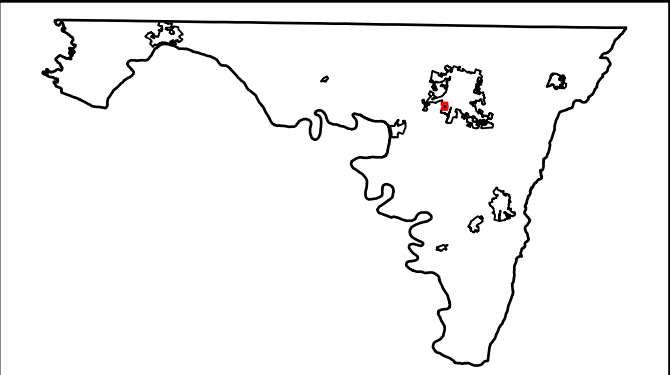

# Marsh Pike - Longmeadow Road Area



# Massey Boulevard



# Maugans Avenue - Longmeadow Road

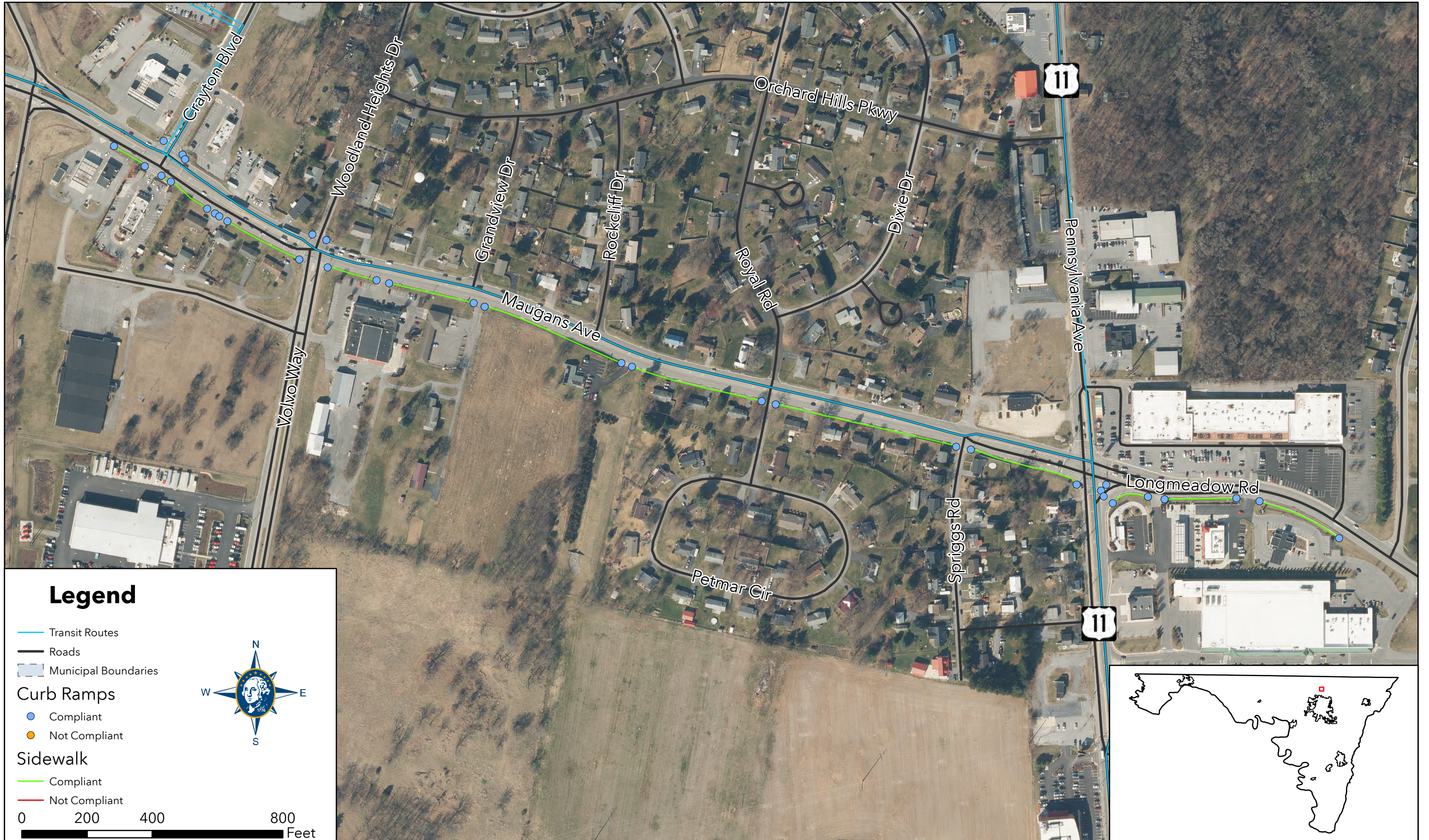

# Maugans Avenue



# Maugansville Area





# Oak Hill Avenue



# Oak Valley Drive - Halfway Boulevard



# Pin Oak Road



# Robinwood Drive - Academic Boulevard

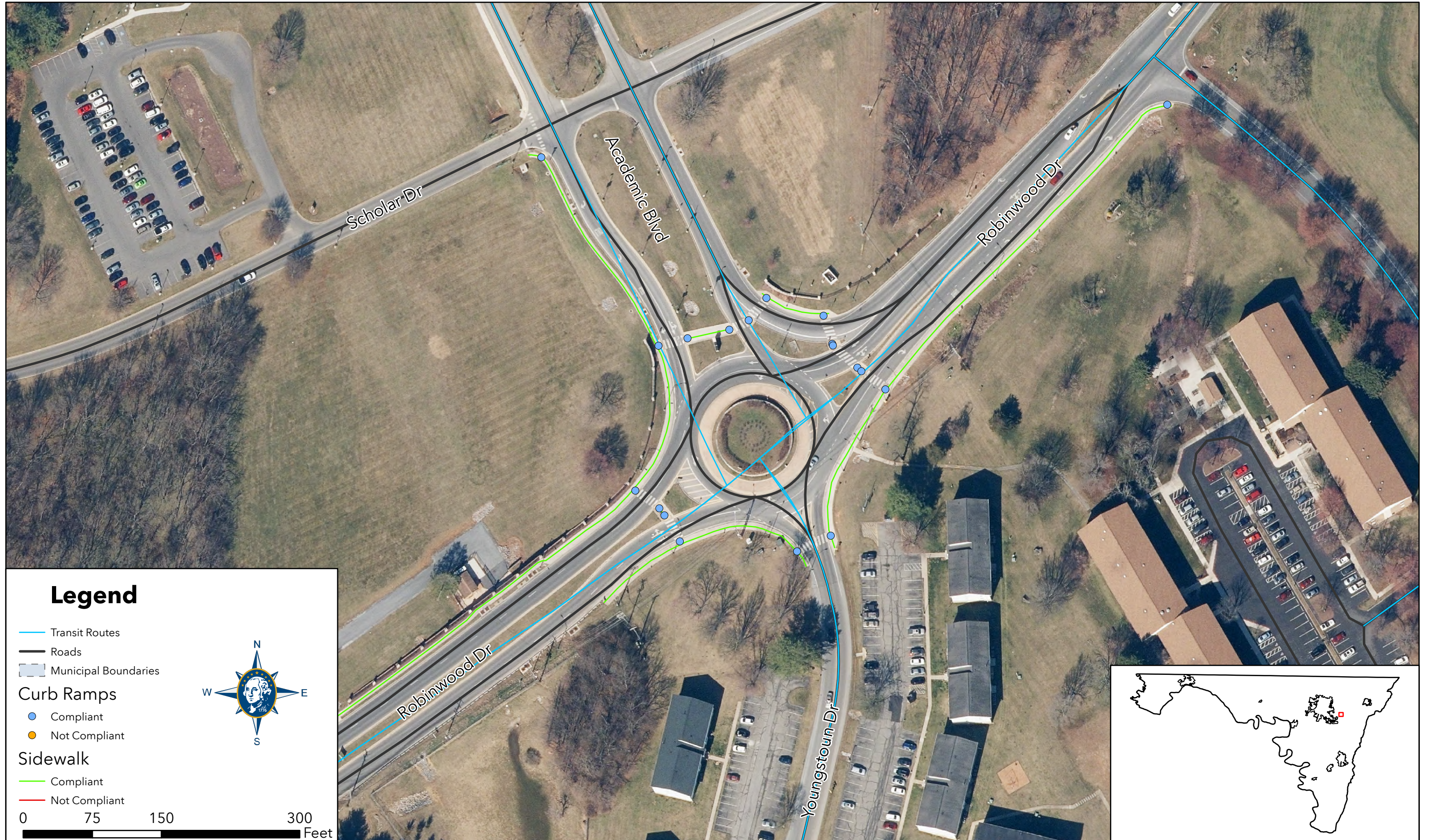

# Sharpsburg Pike Area

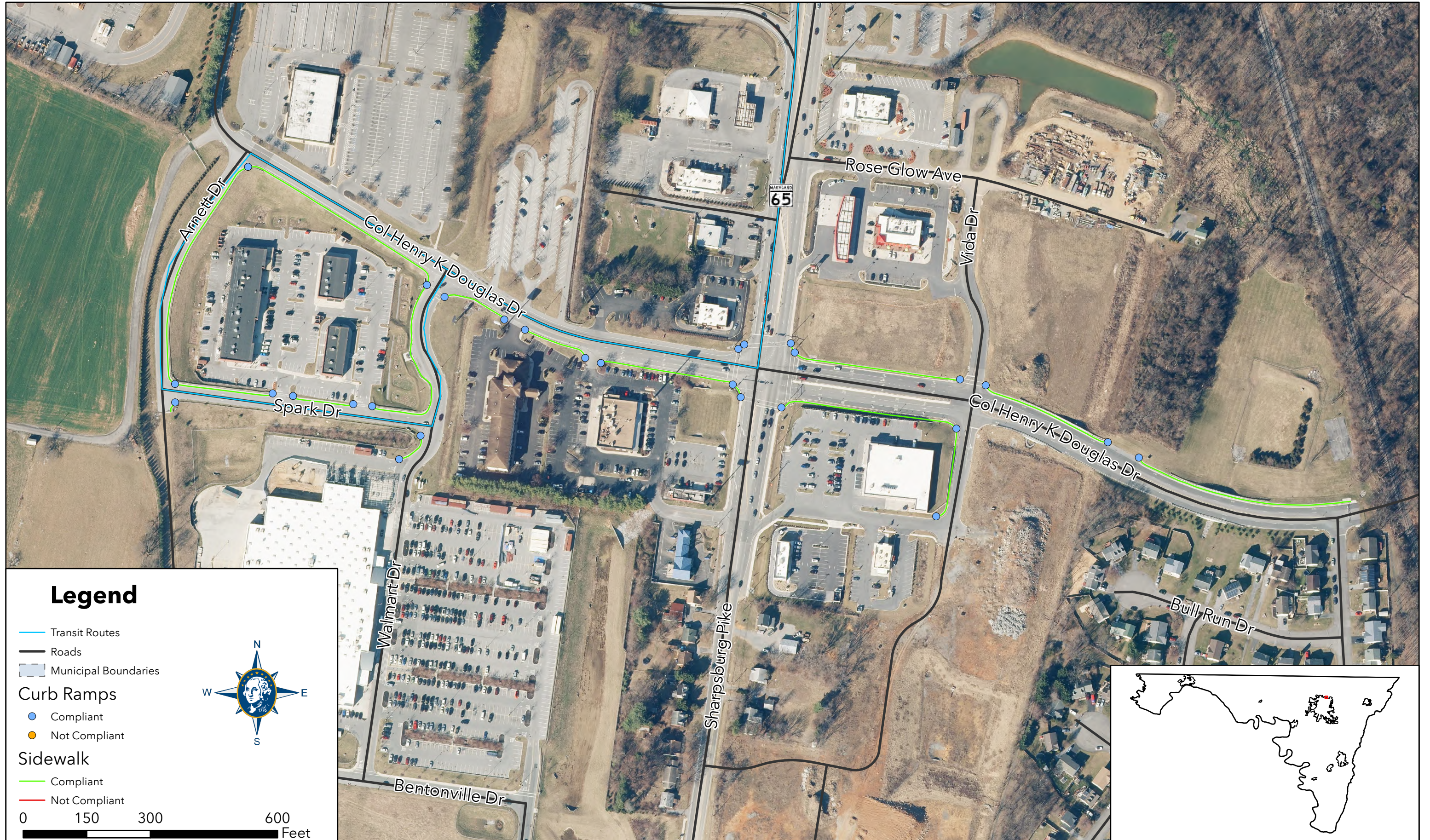

# Shelby Circle - Distant View Drive



# South Pointe Area - Southern Boulevard



# Sweet Vale Drive





# Virginia Avenue Area



# Westfields Area



# Yale Drive - Medical Campus Road



# Yale Drive - Professional Boulevard

