



# REQUEST FOR QUOTATION

PLEASE COMPLETE THE FOLLOWING CONTACT INFORMATION:

NOTES:

Company Name: \_\_\_\_\_  
 Address: \_\_\_\_\_  
 \_\_\_\_\_  
 Contact Name: \_\_\_\_\_  
 Contact Title: \_\_\_\_\_  
 E-mail: \_\_\_\_\_

1. The County reserves the right to reject any and/or all quotes, to waive any technicalities in the quote, and to take whatever action is in the best interest of Washington County.
2. The County is exempt from State of Maryland Sales Tax. The County's Maryland Sales Tax Exemption Number is 30001292.

**RETURN QUOTATIONS TO:**

WASHINGTON COUNTY DIVISION OF ENGINEERING  
 80 West Baltimore Street  
 Hagerstown MD 21740

Attention: Scott Hobbs – Director

Telephone Number: 240-313-2460

## REQUEST FOR QUOTATION

DATE ISSUED

9/14/18

DESCRIPTION

**ADA SIDEWALK RAMPS**  
**DIVISION OF ENGINEERING**  
*(See Attached Instructions & Specifications)*

PRICE (See form of Proposal)

**QUOTATION DUE: Friday, September 28, 2018, no later than 4:00 P.M. by e-mail ([ecquotes@washco-md.net](mailto:ecquotes@washco-md.net)), fax (240-313-2401), or delivered.**

**IF DELIVERED, QUOTATIONS TO BE ADDRESSED TO:** Washington County Division of Engineering, Attn: Scott Hobbs, Director, Washington County Administrative Annex, 80 West Baltimore Street, Hagerstown, Maryland, 21740 and enclosed in a sealed opaque envelope marked "QUOTATION – ADA SIDEWALK RAMPS" and bearing the vendor's name.

Having received clarification on all items of conflict or upon which any doubt arose, the undersigned proposed to furnish all labor, materials and equipment called for by said specifications and instructions on the attached Quotation Proposal Form.

Official Signature \_\_\_\_\_

Name Printed \_\_\_\_\_

Telephone Number \_\_\_\_\_

Acknowledge Addenda # \_\_\_\_\_ Date \_\_\_\_\_

# \_\_\_\_\_ Date \_\_\_\_\_, # \_\_\_\_\_ Date \_\_\_\_\_

## ADA SIDEWALK RAMPS

### NOTICE TO QUOTERS & INSTRUCTIONS

1. **QUOTATION SUBMISSION:** Quotations are due by e-mail ([ecquotes@washco-md.net](mailto:ecquotes@washco-md.net)), fax (240-313-2401) or delivery. If delivered, the quotation shall be enclosed in a sealed opaque envelope bearing the name of the Quoter and marked “**QUOTATION – ADA SIDEWALK RAMPS**” Quotations are to be addressed to Washington County Division of Engineering, Washington County Administrative Annex, 80 West Washington Street, Hagerstown, MD 21740. Please direct all general inquiries to Scott Hobbs, Director. **Quotations must be received no later than Friday, September 28, 2018 at 4:00 P.M.**
2. **PRE-QUOTATION CONFERENCE:** No conference will be scheduled.
3. **SITE VISITS:** It is strongly encouraged that each Bidder submitting a quotation for this work examine the site and thoroughly satisfy himself/herself to the conditions under which he/she will operate or that will in any manner affect any work under his/her contract. The Bidder shall accept the site as he/she finds them. All proposals shall take into consideration all conditions that may affect the work. No allowance shall be made to any Bidder for negligence in this respect.
4. **AWARD OF CONTRACT:** The base bid or the base bid plus alternates selected will be used as a basis for evaluation of quotations and award of the Contract. If an award of Contract is made, it will be made to the responsible Bidder who submits the lowest, responsive quotation. Carelessness in quoting prices, or in preparation of quotation otherwise, will not relieve the Quoter. Erasures or changes in quotations must be initialed.
5. **DISPUTES:** In cases of disputes as to whether or not an item or service quoted or delivered meets specifications, the decision of the County Commissioners or authorized representative shall be final and binding on both parties.
6. **EQUAL OPPORTUNITY:** The Board of County Commissioners of Washington County, Maryland does not discriminate on the basis of race, color, national origin, sex, religion, age and disability in employment or the provision of services.
7. **EXCEPTION:** The submission of a quote shall be considered an agreement to all items, conditions, and specifications provided herein and in the various quotation documents unless specifically noted otherwise in the proposal.
8. **INSURANCE:** Upon request and prior to execution of contract, the successful contractor must show Evidence of Insurance as outlined in the attached copy of Washington County Policy No. P-4 (Attachment No. 1).
9. **INTERPRETATION, DISCREPANCIES, OMISSIONS:** Should any Bidder find discrepancies in, or omissions from the documents or be in doubt of their meaning, or feel that the specifications are discriminatory, he/she should at once request an interpretation, in writing, from:

Scott Hobbs – Director  
Washington County Division of Engineering  
Washington County Administrative Annex  
80 West Baltimore Street  
Hagerstown, MD 21740  
E-mail: [ecbidquestions@washco-md.net](mailto:ecbidquestions@washco-md.net)  
Fax: 240-313-2401

All necessary interpretations will be issued to all bidders in the form of addenda to the specifications, and such addenda shall become part of the contract documents. Exceptions as taken in no way obligates the County to change the specifications. Failure of any Bidder to receive any such addendum or interpretation shall not relieve such Bidder from any obligation under his/her bid as submitted. The County will assume no responsibility for oral instructions or suggestions. **ORAL ANSWERS WILL NOT BE BINDING ON THE COUNTY.** No questions/requests received after 4:00 P.M., local time, Wednesday, September 19, 2018 will be considered.

10. **TIME OF COMPLETION AND LIQUIDATED DAMAGES:** Bidder must agree to commence work within three (3) calendar days of receipt of written “Notice to Proceed” by the County and to fully complete the project within **25** consecutive calendar days thereafter.

The proposed Notice to Proceed date for this project is **OCTOBER 8, 2018** and, therefore the proposed calendar date of completion for the entire project will be **NOVEMBER 1, 2018**. The bidder must agree to pay as liquidated damages, the sum of **\$250.00** for each consecutive calendar thereafter.

Time is an essential element of the Contract and it is important that the Work be vigorously prosecuted until Final Acceptance. The Contractor understands and agrees that the County and the general public will suffer financial loss and/or inconvenience if the Project is not substantially complete on the date set forth in the Contract Documents. The County and the Contractor agree that the amount of financial loss and/or inconvenience is not subject to accurate estimation and the actual damages are not easily ascertained. Therefore, the County and the Contractor agree that the amount of liquidated damages set forth in the Contract Documents is a reasonable forecast of the just and fair compensation for the harm that would result from the Contractor’s failure to timely complete the work.

For each calendar day that the Work shall remain uncompleted beyond the Contract Time, the Contractor and/or the Surety shall be liable for liquidated damages in the amount provided for in the Contract Documents, provided, however, that due account shall be taken of any adjustment of the Contract time for completion of work as granted by approved equitable adjustments.

11. **DISPOSAL FEES:** Disposal of items shall be at an approved location or landfill and any fees for same must be included in the contractor's quotation.
12. **PRICE PROPOSAL:** A price proposal shall include unit prices for all work items provided in the bid forms herein. The total sum for the work listed in the Task Order of Work/Specifications shall include the cost of any and all permits and/or fees, the cost of all applicable seals and other taxes required by Local, State and Federal laws, the cost of bonds and insurances required, the cost of all material, labor, tools, equipment, transportation, landfill users fees, superintending and

other services and facilities of every nature whatsoever or as may be necessary to complete the work as described in the specifications. The County will waive the permit fees for permits issued under County jurisdiction.

13. **PAYMENT:** Payment will be made within thirty (30) days after satisfactory acceptance. Invoices shall be submitted in duplicate to Mr. Scott Hobbs, Director, Division of Engineering, 80 West Baltimore Street, Hagerstown, Maryland 21740. Invoices submitted without clear, concise, readable, definitive information shall be returned for clarification, and may delay payment. Invoices must include the site name and the Washington County-issued Purchase Order (P.O.) number.
14. **PAYMENT OF COUNTY AND MUNICIPAL TAXES:** Effective October 1, 1993, in compliance with Section 1-106(b)(3) of the Code of the Public Local Laws of Washington County, Maryland, "If a Bidder has not paid all taxes owed to the County or a municipal corporation in the County, the County Commissioners may reject the Bidder's bid."
15. **POLITICAL CONTRIBUTION DISCLOSURE:** In accordance with Maryland Code, State Finance and Procurement Article, §17-402, the Bidder shall comply with Maryland Code, Election Law Article, Title 14, which requires that every person that enters into contracts, leases, or other agreements with the State, a county, or any incorporated municipality, or their agencies during a calendar year in which the person receives in the aggregate \$100,000 or more, shall file with the State Administrative Board of Election Laws a statement disclosing contributions in excess of \$500 made during the reporting period to a candidate for elective office in any primary or general election. The statement shall be filed with the State Administrative Board of Election Laws: (1) before a purchase or execution of a lease or contract by the State, a county, an incorporated municipality or their agencies, and shall cover the preceding two (2) calendar years; and (2) if the contribution is made after the execution of a lease or contract, then twice a year, throughout the contract term, on: (a) February 5, to cover the 6-month period ending January 31; and (b) August 5, to cover the 6-month period ending July 31.
16. **RESERVATIONS:** The Board of County Commissioners of Washington County, Maryland, reserves the right to accept or reject any or all quotes, to waive formalities, informalities and technicalities therein. The Board reserves the right to contact a Quoter for clarifications and may, at its sole discretion, allow a Quoter to correct any and all formalities, informalities and technicalities in the best interest of the Washington County.
17. **SALES TAX:** The County is exempt from State of Maryland Sales Tax. The County's Sales Tax Exemption Number is 3000129-2. The Bidder is responsible to make any necessary inquiries and investigations with regulating state agencies to obtain a determination of tax exemptions in his/her quotation.
19. **WORK SITE DAMAGES:** Any damage to finished surfaces, surrounding areas, building, etc., shall be repaired to the damaged party's satisfaction at the Contractor's expense.
20. **FINAL ACCEPTANCE SIGN-OFF:** Final acceptance shall take place after all deficiencies noted by the Washington County Project Manager have been corrected to his/her satisfaction.
21. **PRICES VALID:** All quoted prices shall be valid for ninety (90) consecutive calendar days after submission of quote.

22. **GENERAL CONDITIONS FOR CONSTRUCTION CONTRACTS:** Contractor advised that contract shall abide by Washington County General Conditions for Construction, dated October 2008.

## Quotation

### ADA SIDEWALK RAMPS

#### TASK ORDER OF WORK

#### 1. SUMMARY:

- A. This quotation shall be for the work associated with installation of sidewalk, drains, curb, curb ramps, and dumpster pad as specified including the removal and disposal of existing concrete and asphalt necessary for the work as well as all material, labor, equipment, tools, and incidentals necessary to complete the work. *All work shall comply with the 2010 guidelines of the Americans with Disabilities Act (ADA) Standards for Accessible Design and the latest revision thereto.* The Contractor shall submit all applicable material specifications to the Engineer for review and approval prior to the start of work.

#### 2. RESPONSIBILITIES OF THE COUNTY AND CONTRACTOR:

- A. Unless otherwise advised, Mr. Scott Hobbs, Director, shall be the Owner's designated representative and point of contact for matters relating to the performance of this work.
- B. The Contractor is responsible for the maintenance of traffic during construction and shall adhere to an approved traffic control plan or operation for traffic in and out of the alley and parking lot. The parking lot shall remain open at all times during normal business hours and the alley shall remain open unless approved otherwise. Vehicles near the work area will be temporarily relocated to provide adequate access to the work.
- C. The Contractor shall complete the work described herein within the time specified herein following receipt of a written notice to proceed from the Owner.
- D. All work associated with this proposal shall be completed in accordance with the applicable standards, codes, laws and regulations adopted by the Authority Having Jurisdiction (AHJ). This project is located within the State of Maryland, County of Washington.
- E. The Contractor shall take all necessary precautions for the protection of the work and safety of the public, all as indicated in the MUTCD.
- F. All equipment, materials, and vehicles shall be stored outside the road clear zone. Driveway entrances shall not be blocked at any time unless coordinated with the property owner and the County.
- G. The Contractor shall notify MISS UTILITY at (800) 257-7777 to arrange for stakeout of utilities at least five days before starting any construction.
- H. Bonds are not required on this project.
- I. There is no MBE/DBE requirements on this project.

J. The location for the project is:

100 West Washington Street, Hagerstown MD 21740

**3. ADDITIONAL INFORMATION IS ATTACHED HERETO FOR INFORMATION PURPOSES:**

Attachment No. 1 – Insurance Requirements

Attachment No. 2 – Aerial Map

Attachment No. 3 – Special Provisions

Attachment No. 4 – Bid Forms

Attachment No. 5 – Standard Details

Attachment No. 6 – Project Photos

Attachment No. 7 – Washington County, MD General Conditions for Construction  
October 2008

FORM OF PROPOSAL

TO:

The Board of County Commissioners  
of Washington County, Maryland  
c/o Washington County Division of Engineering  
Washington County Administrative Annex  
80 West Baltimore Street  
Hagerstown, MD 21740

FROM:

\_\_\_\_\_  
\_\_\_\_\_  
\_\_\_\_\_

DATE: \_\_\_\_\_

QUOTATION DUE: Friday, September 28, 2018  
4:00 P.M.

Ladies/Gentlemen:

We hereby submit our proposal for:

**ADA SIDEWALK RAMPS**

Having examined the site and being familiar with pertinent local conditions affecting the work and having carefully examined the contents of this Quotation Package bearing the project title, and dated \_\_\_\_\_, including

Addenda (if any):

Addendum No. \_\_\_\_\_ Dated \_\_\_\_\_

and having received clarification on all items of conflict or upon which any doubt arose, the undersigned proposes to furnish all labor, materials and equipment called for by the said documents for the entire work, in strict accordance with the specifications, for the stipulated sum of:

Base Bid

\_\_\_\_\_ DOLLARS (\$ \_\_\_\_\_ )  
Written Figures

Add Alternates

\_\_\_\_\_ DOLLARS (\$ \_\_\_\_\_ )  
Written Figures

Base Bid + Add Alternates

\_\_\_\_\_ DOLLARS (\$ \_\_\_\_\_ )  
Written Figures



FIRM NAME AND ADDRESS: \_\_\_\_\_

\_\_\_\_\_

BY (Signature): \_\_\_\_\_

NAME AND TITLE (Printed): \_\_\_\_\_

TELEPHONE NO: \_\_\_\_\_

FAX NUMBER: \_\_\_\_\_

E-MAIL ADDRESS: \_\_\_\_\_

DATE: \_\_\_\_\_

FEDERAL EMPLOYER'S IDENTIFICATION NUMBER: \_\_\_\_\_

ATTACHMENT NO. 1

**POLICY TITLE:** Insurance Requirements for Independent Contractors

**POLICY NUMBER:** P-4

**ADOPTION DATE:** August 29, 1989

**EFFECTIVE DATE:** September 1, 1989

**FILING INSTRUCTIONS:**

**I. PURPOSE**

To protect Washington County against liability, loss or expense due to damaged property, injury to or death of any person or persons and for care and loss of services arising in any way, out of, or in connection with or resulting from the work or service performed on behalf of Washington County.

**II. ACTION**

The following should be inserted in all Independent Contractor Contracts:

"The Contractor shall procure and maintain at his sole expense and until final acceptance of the work by the County, insurance as hereinafter enumerated in policies written by insurance companies admitted in the State of Maryland, have A.M. Best rating of A- or better or its equivalent, and acceptable to the County."

1. **Workers Compensation:** The Contractor agrees to comply with Workers Compensation laws of the State of Maryland and to maintain a Workers Compensation and Employers Liability Policy.

Minimum Limits Required:

Workers Compensation -	Statutory
Employers Liability -	\$100,000 (Each Accident)
	\$500,000 (Disease - Policy Limit)
	\$100,000 (Disease - Each Employee)

2. **Comprehensive General Liability Insurance:** The Contractor shall provide Comprehensive General Liability including Products and Completed Operations.

Minimum Limits Required:

\$1,000,000 combined single limit for Bodily Injury and Property Damage.

Such insurance shall protect the County, its agents, elected and appointed officials, commission members and employees, and name Washington County on the policy as additional insured against liability, loss or expense due to damaged property (including loss of use), injury to or death of any person or persons and for care and loss of services arising in any way, out of, or in connection with or resulting from the work of service performed on behalf of Washington County.

The Contractor is ultimately responsible that Subcontractors, if subcontracting is authorized, procure and maintain at their sole expense and until final acceptance of the work by the County, insurance as hereinafter enumerated in policies written by insurance companies admitted in the State of Maryland, have A.M. Best rating of A- or better or its equivalent, and acceptable to the County.

3. **Business Automobile Liability:** The Contractor shall provide Business Auto Liability including coverage for all leased, owned, non-owned and hired vehicles.

Minimum Limits Required:

\$1,000,000 combined single limit for Bodily Injury or Property Damage.

**Certificate(s) of Insurance:** The Contractor shall provide certificates of insurance requiring a 30 day notice of cancellation to the Insurance Department, Board of County Commissioners of Washington County prior to the start of the applicable project.

Approval of the insurance by the County shall not in any way relieve or decrease the liability of the Contractor. It is expressly understood that the County does not in any way represent that the specified limits of liability or coverage or policy forms are sufficient or adequate to protect the interest or liabilities of the Contractor.

All responsibility for payment of any sums resulting from any deductible provisions, corridor, or self-insured retention conditions of the policy or policies shall remain with the Contractor.

**General Indemnity:** The Contractor shall indemnify, defend and save harmless the Board of County Commissioners of Washington County, its appointed or elected officials, commission members, employees and agents for any and all suits, legal actions, administrative proceedings, claims, demands, damages, liabilities, interest, attorneys fees, costs and expenses of whatsoever kind of nature, whether arising before or after final acceptance and in any manner directly or indirectly caused, occasioned or contributed to in whole or in part by reason of any act, error or omission, fault or negligence whether active or passive by the Contractor, or any one acting under its direction, control or on its behalf in connection with or incident to its performance of the Contract.

Revision Date: August 27, 1991  
Effective Date: August 27, 1991  
Revision Date: March 4, 1997  
Effective Date: March 4, 1997

# Quick Tips Understanding the Acord Certificate of Insurance

Washington County, Maryland

**ACORD, CERTIFICATE OF INSURANCE**

ISSUE DATE (MM/DD/YY)  09/02/99

1. **PRODUCER**  
Insurance Agent/Broker who issues certificate.

2. **NAME OF INSURED**  
Must be the legal name of the contracting party.

3. **TYPES OF INSURANCE**  
Must include the types of insurance required by contract.

4. **POLICY FORM**  
"Claims made" or "occurrence" form

5. **NAMED ADDITIONAL INSURED**  
The Board of County Commissioners of Washington County, MD must be named as additional insured.

6. **CERTIFICATE HOLDER**  
Must be Board of County Commissioners of Washington County MD

7. **POLICY EFFECTIVE DATE**  
Must be prior to or coincidental with effective date of contract.

8. **POLICY EXPIRATION DATE**  
If occurrence form, date must be on or after termination of contract.

9. **LIMITS OF INSURANCE**  
Must be the same or greater than required by contract. See minimums below.

10. **DESCRIPTION OF OPERATIONS**  
The County is named additional insured here; place & event sometimes described here.

11. **NOTICE OF CANCELLATION**  
Must be modified as indicated; 30 days required.

12. **AUTHORIZED REPRESENTATIVE**  
Must be signed, not stamped.

PRODUCER: Bill Jones Insurance Agency, License #0C32505, 40 E. Main St., Ste. 1100, Baltimore, MD 94405, Ph.#: 800/663-005

INSURED: XYZ Construction, P. O. Box 41229, Hagerstown, MD 21740

COMPANIES AFFORDING COVERAGE:  
 COMPANY LETTER A TRAVELERS INDEMNITY OF WISCONSIN  
 COMPANY LETTER B RELIANCE INSURANCE OF PENNSYLVANIA  
 COMPANY LETTER C STATE INSURANCE COMPANY  
 COMPANY LETTER D  
 COMPANY LETTER E

CO. LETTER	TYPE OF INSURANCE	POLICY NUMBER	POLICY EFFECTIVE DATE (MM/DD/YY)	POLICY EXPIRATION DATE (MM/DD/YY)	ALL LIMITS (IN THOUSANDS)
A	GENERAL LIABILITY <input type="checkbox"/> OPERATIONAL-GENERAL LIABILITY <input checked="" type="checkbox"/> CLAIMS MADE <input checked="" type="checkbox"/> OCCUR <input type="checkbox"/> OTHERS & CONTRACTORS PRINT	NGA0105086-09	10/1/06	10/1/07	GENERAL AGGREGATE \$ 1,000,000 PRODUCTS-COMPOSITS AGGREGATE \$ 1,000,000 PERSONAL & ADVERTISING AGENCY \$ 1,000,000 EACH OCCURRENCE \$ 1,000,000 PER OCCURRENCE \$ MEDICAL EXPENSE (Any one person) \$ Exclud.
B	AUTOMOBILE LIABILITY <input type="checkbox"/> NY AUTO <input checked="" type="checkbox"/> ALL OWNED AUTOS <input checked="" type="checkbox"/> RENTED AUTOS <input checked="" type="checkbox"/> TRIP AUTOS <input type="checkbox"/> NON-OWNED AUTOS <input type="checkbox"/> DAMAGE LIABILITY	0105081-RDE	4/7/07	4/7/08	UNLIMITED BODILY INJURY \$ 1,000,000 BODILY INJURY TO EMPLOYEES \$ BODILY INJURY TO ASSAULT \$ PROPERTY DAMAGE \$
C	EXCESS LIABILITY <input checked="" type="checkbox"/> UMBRELLA FORM <input type="checkbox"/> OTHER THAN UMBRELLA FORM	46699898	1/10/07	1/10/08	EACH OCCURRENCE \$1,000,000 AGGREGATE \$
B	WORKERS COMPENSATION AND EMPLOYERS LIABILITY	JKA010-9087654	4/7/07	4/7/08	STATUTORY LIMITS \$ 1,000,000 EACH ACCIDENT \$ 1,000,000 PER POLICY LIMIT \$ 1,000,000 PER SEVERE EACH EMPLOYEE

DESCRIPTION OF OPERATIONS/LOCATIONS/SUBSIDIARIES/RESTRICTIONS/SPECIAL ITEMS  
 The Board of County Commissioners, Washington County, MD, its appointed or selected officials, officers, agents, and employees are named as additional insureds.

CERTIFICATE HOLDER: Board of County Commissioners of Washington County, MD, 100 N. Washington St., Hagerstown, MD 21740

CANCELLATION: SHOULD ANY OF THE ABOVE DESCRIBED POLICIES BE CANCELLED BEFORE THE EXPIRATION DATE THEREOF, THE ISSUING COMPANY WILL endeavor TO MAIL 30 DAYS WRITTEN NOTICE TO THE CERTIFICATE HOLDER NAMED TO THE LEFT, BUT FAILURE TO MAIL SUCH NOTICE SHALL IMPOSE NO OBLIGATION ON THE PART OF THE ISSUING COMPANY, THE POLICY OR POLICIES DESCRIBED.

AUTHORIZED REPRESENTATIVE: Bill Jones

ACORD 25-S (1/78) ACORD CORPORATION 1988

1. THE PRODUCER: Produces or orders Certificate for Insured; answers questions, revises certificate to meet contract requirements.
2. NAME OF INSURED: Must be legal name of contracting party.
3. TYPES OF INSURANCE: Must include types required by contract.
4. POLICY FORM: Will indicate claims-made or occurrence form; see "8. Policy Expiration Date" and Glossary for additional information.
5. NAMED ADDITIONAL INSURED: The Certificate must state, either under Description of Operations or by attached endorsement, that Board of County Commissioners is additional insured.
6. CERTIFICATE HOLDER: Must be Board of County Commissioners of Washington County, MD -- include department, contact person.
7. POLICY EFFECTIVE DATE: Must be prior to or coincidental with effective date of contract.
8. POLICY EXPIRATION DATE: For "occurrence" form coverage, date should be on or after the termination date of contract; if "claims-made coverage," coverage must survive for a period not less than three years following termination of contract and shall provide for a retroactive date of placement prior to or coinciding with the effective date of contract.
9. LIMITS OF INSURANCE: Must be same or greater than required by contract.
10. DESCRIPTION OF OPERATIONS: Review information in this section to determine it is consistent with contract.
11. NOTICE OF CANCELLATION: This language must be modified to read: "Should any of the above described policies be cancelled before the expiration date thereof, the issuing company will mail 30 days notice to the certificate holder named to the left."
12. AUTHORIZED REPRESENTATIVE: Must be signed by an authorized representative of Producer.

Quick Tips: Understanding the Acord Certificate of Insurance • 07/07

ATTACHMENT 2

100 West Washington Street Parking Lot



Legend



- Parcel Boundaries
- 100 West Washington St Parking Lot

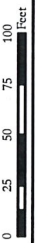

ATTACHMENT 3

**SPECIAL PROVISIONS**  
**FOR**  
**ADA SIDEWALK RAMPS**  
**IN**  
**WASHINGTON COUNTY, MARYLAND**

.....  
**THE PROJECT**

This project consists of ADA sidewalk curb ramp improvements, and concrete slab work at 100 West Washington Street. The proposed project includes removal of existing sidewalk and curb; new sidewalk, drains, curb ramps, and concrete pad construction.

**TABLE OF CONTENTS**

**CATEGORY 100 - PRELIMINARY**

Item No. 101 – MOBILIZATION.....	SP-1
Item No. 102 – MAINTENANCE OF TRAFFIC.....	SP-1/2

**CATEGORY 200 - GRADING**

Item No. 201 – UNCLASSIFIED EXCAVATION.....	SP-3
Item No. 202 – REMOVAL OF EXISTING PAVEMENT, SIDEWALK AND PAVED DITCHES.....	SP-4
Item No. 203 – REMOVAL OF EXISTING CURB OR COMBINATION CURB AND GUTTER.....	SP-4

**CATEGORY 300 - DRAINAGE**

Item No. 301 – SELECT BACKFILL USING NO. 57 AGGREGATE.....	SP-5
Item No. 302 – SELECT BACKFILL USING CRUSHER RUN AGGREGATE (CR-6) .....	SP-5

**CATEGORY 400 – STRUCTURES**

Item No. 401 – MIX NO. 3 CONCRETE FOR DUMPSTER PAD.....	SP-6/7
---	--------

**CATEGORY 600 - SHOULDERS**

Item No. 601 – 5 INCH CONCRETE SIDEWALK AND SIDEWALK RAMPS.....	SP-8
Item No. 602 – 6” COMBINATION CURB AND GUTTER .....	SP-9
Item No. 603 – 6” CURB .....	SP-9
Item No. 603A – 6” CURB (ADD ALTERNATE).....	SP-9
Item No. 604 – CAST-IN-PLACE, REPLACEABLE DETECTABLE WARNING SURFACES.....	SP-9/10



- B. All personnel on the project site shall comply with MOSH and Federal OSHA regulations. At a minimum, all personnel shall wear reflective safety vests within the work zone and/or the road right-of-way.

**.04 MEASUREMENT AND PAYMENT:** Maintenance of Traffic will not be measured for payment, but will be paid for at the Contract lump sum price. The payment will be full compensation for all work necessary to maintain traffic including all work, sequence of operations, and flagmen for the fulfillment of the Contract requirements and implementation of the approved Traffic Control Plan. Payment will be prorated and paid in equal amounts on each monthly estimate. The number of months used for prorating will be the number of Contract calendar days divided by 30.

**Item No. 202 – REMOVAL OF EXISTING PAVEMENT, SIDEWALK, PAVED DITCHES**

**Item No. 203 - REMOVAL OF EXISTING CURB OR COMBINATION CURB AND GUTTER**

**Item No. 203A - REMOVAL OF EXISTING CURB OR COMBINATION CURB AND GUTTER (ADD ALTERNATE)**

**.01 DESCRIPTION:** Remove to full depth and dispose of existing pavement, sidewalk, paved ditches, curb, or combination curb and gutter.

**.02 MATERIALS:** Not applicable.

**.03 CONSTRUCTION:**

03.01 Full Depth Saw Cut. Saw cut to full depth the existing pavement, sidewalk, paved ditches, curb, or combination curb and gutter along the lines specified or as directed.

03.02 Use of Removed Pavement, Sidewalk, Paved Ditches, Curb, or Combination Curb and Gutter. When approved, removed materials may be broken and used in the work. Refer to Section 204.02.01 of the MDOT SHA Standard Specifications.

03.03 Protection of Retained Pavement, Sidewalk, Paved Ditches, Curb, or Combination Curb and Gutter. Protect all sections designated to remain from being damaged. Repair or replace damaged areas.

**.04 MEASUREMENT AND PAYMENT:** Removal of existing pavement, sidewalk, paved ditches will be measured and paid for at the Contract unit price bid per cubic yard. Removal of existing curb or combination curb and gutter will be measured and paid for at the Contract unit price bid per linear foot. The payment will be full compensation for all material, labor, equipment, tools, and incidentals necessary to complete the work. Saw cuts will not be measured and the cost will be incidental to the project.

## CATEGORY 400 – STRUCTURES

### **Item No. 401 – MIX NO. 3 CONCRETE FOR DUMPSTER PAD**

**.01 DESCRIPTION:** This work shall consist of the construction of cast-in-place reinforced concrete including furnishing, proportioning, mixing, placing, finishing, curing and protecting the concrete.

**.02 MATERIALS:**

Concrete SHA Mix No.3	MDOT SHA Standard Section 902.10.03, 915.03
Reinforcement	MDOT SHA Standard Section 908

**.03 CONSTRUCTION:** Refer to MDOT SHA Standard Specifications Section 603.03 and the following:

- A. All cast in place concrete shall be MDOT SHA Mix No. 3 (3,500 p.s.i.).
- B. The Contractor shall be responsible for sampling, molding, curing, transporting, and testing concrete test specimen for compressive strength analysis in conformance with AASHTO/ASTM specifications. As a minimum, the Contractor shall take four (4) concrete cylinders per pour for each mix design and/or as directed by the Engineer. The field concrete testing shall include slump test, air content test, and temperature information on freshly mixed concrete. All necessary paperwork shall be prepared by the Contractor, and sent along with the concrete test cylinders to a laboratory approved by the Engineer. The specimens shall not be transported from field to laboratory before completion of initial curing. During transportation, specimens shall be cured and protected with suitable cushioning material to prevent damage from jarring and damage by freezing temperatures, or moisture loss. For compressive strength testing each set of concrete cylinders shall be tested as follows:
  - One (1) concrete cylinder shall be broken at seven (7) days.
  - One (1) concrete cylinder shall be broken at fourteen (14) days.
  - Two (2) concrete cylinders shall be broken at twenty-eight (28) days.

The compressive strength test results report, for each concrete cylinder, shall be submitted to the Engineer no later than 48 hours after actual break time period. The Engineer may change the test frequency for the concrete cylinder breaks as noted above.

The Contractor shall provide and pay for an approved Field Technician to perform the field sampling and testing. Cost associated with field sampling and testing of concrete shall be at the expense of the Contractor.

**CATEGORY 600 – SHOULDERS**

**Item No. 601 - 5 INCH CONCRETE SIDEWALK AND SIDEWALK RAMPS**

**.01 DESCRIPTION:** This work shall consist of constructing concrete sidewalks (5" depth) and ramps as shown on the Plans, Details, and/or as directed by the Engineer.

**.02 MATERIALS:**

Curing Materials	MDOT SHA Standard Section 902.07
Form Release Compound	MDOT SHA Standard Section 902.08
Concrete Mix No.3	MDOT SHA Standard Section 902.10.03
Welded Wire Fabric	MDOT SHA Standard Section 908
Joint Sealer	MDOT SHA Standard Section 911.01
Preformed Joint Filler	MDOT SHA Standard Section 911.02
Roofing Paper	MDOT SHA Standard Section 911.07
Sidewalk Drains 3/8" Galvanized Diamond Tread Plate	

**.03 CONSTRUCTION:** Refer to MDOT SHA Standard Specifications Section 603.03 and the following:

- A. The Contractor will be required to provide as a minimum, test for slump, air content, mix temperature and four (4) cylinders per pour for laboratory testing including delivery to the County approved testing laboratory. Test results shall be provided to the County with copies of all test results provided to the Contractor. Testing and acceptance parameters shall be in accordance with MDOT SHA Standard Supplemental Specifications Section 902, with the exception that the Contractor shall provide and pay for an approved Field Technician to perform the field sampling and testing. Cost associated with field sampling and testing of concrete shall be at the expense of the Contractor.

**.04 MEASUREMENT AND PAYMENT:** Concrete sidewalks will be measured and paid at the Contract unit price per square foot. The payment will include: excavation, backfill, disposal of excess or unsuitable material, forms, reinforcement when specified, joints, sealer, compaction, curing, finishing, aggregate reservoir stone, and all material, labor, equipment, tools, and incidentals necessary to complete the work.

The cost to furnish and install the sidewalk drains is incidental to this work.

manufacturer's recommendations. These recommendations shall address the conditions of the concrete surface on which the system is to be applied, surface finish, presence of curing compound, length of cure, etc. The recommendations shall also address ambient temperature, moisture conditions, adhesive shelf life, set time, tools required, and other details about the technique of system installation.

**.04 MEASUREMENT AND PAYMENT:** Detectable Warning Surfaces will be measured and paid for at the Contract unit price per square foot. The payment will be full compensation for removal and disposal of old treatments, including adhesives and sealants, reapplying, and for all material, labor, equipment, tools, and incidentals necessary to complete the work.

The sidewalk on which the detectable warning surface is placed will be measured and paid for at the Contract price for the pertinent Sidewalk item.

ATTACHMENT 4

**BID FORMS**

**SUMMARY SCHEDULE OF PRICES**

Category 100 .....\$ \_\_\_\_\_

Category 200 .....\$ \_\_\_\_\_

Category 300 .....\$ \_\_\_\_\_

Category 400 .....\$ \_\_\_\_\_

Category 600 .....\$ \_\_\_\_\_

Total (Categories 100, 200, 300, 400, 600) .....\$ \_\_\_\_\_

Add Alternates .....\$ \_\_\_\_\_

Total with Add Alternates .....\$ \_\_\_\_\_

**BID FORMS**

ITEM	CODE	QUANTITY	UNIT	ITEM DESCRIPTION	UNIT PRICE		ITEM TOTAL	
101		LUMP SUM	L.S.	MOBILIZATION	—	—	—	
102		LUMP SUM	L.S.	MAINTENANCE OF TRAFFIC	—	—	—	
					—	—	—	
					—	—	—	
					—	—	—	
					—	—	—	
					—	—	—	
					—	—	—	
End Category <u>100</u>				Total This Sheet				—



**BID FORMS**

ITEM	CODE	QUANTITY	UNIT	ITEM DESCRIPTION	UNIT PRICE	ITEM TOTAL
201		50	C.Y.	UNCLASSIFIED EXCAVATION	—	—
202		20	C.Y.	REMOVAL OF EXISTING PAVEMENT, SIDEWALK, PAVED DITCHES	—	—
203		98	L.F.	REMOVAL OF EXISTING CURB OR COMBINATION CURB AND GUTTER	—	—
					—	—
					—	—
					—	—
					—	—
					—	—
					—	—
<b>End Category 200</b>					Total This Sheet	—

**BID FORMS**

ITEM	CODE	QUANTITY	UNIT	ITEM DESCRIPTION	UNIT PRICE		ITEM TOTAL
301		20	C.Y.	SELECT BACKFILL USING AASHTO NO. 57 AGGREGATE	—	—	—
302		10	C.Y.	SELECT BACKFILL USING CRUSHER RUN AGGREGATE CR-6	—	—	—
					—	—	—
					—	—	—
					—	—	—
					—	—	—
					—	—	—
					—	—	—
End Category <u>300</u>					Total This Sheet		—

**BID FORMS**

ITEM	CODE	QUANTITY	UNIT	ITEM DESCRIPTION	UNIT PRICE	ITEM TOTAL
401		7	C.Y.	MIX NO. 3 CONCRETE FOR DUMPSTER PAD	—	—
					—	—
					—	—
					—	—
					—	—
					—	—
					—	—
					—	—
					—	—
					—	—
					—	—
					—	—
End Category 400					Total This Sheet	—

**BID FORMS**

ITEM	CODE	QUANTITY	UNIT	ITEM DESCRIPTION	UNIT PRICE	ITEM TOTAL
601		304	S.F.	5 INCH CONCRETE SIDEWALK AND SIDEWALK RAMPS	—	—
602		86	L.F.	6" COMBINATION CURB AND GUTTER	—	—
603		27	L.F.	6" CURB	—	—
604		60	S.F.	DETECTABLE WARNING SURFACE FOR CURB RAMPS	—	—
					—	—
					—	—
					—	—
					—	—
<b>End Category 600</b>					Total This Sheet	

**BID FORMS**

ITEM	CODE	QUANTITY	UNIT	ITEM DESCRIPTION	UNIT PRICE	ITEM TOTAL
203A		100	L.F.	REMOVAL OF EXISTING CURB OR COMBINATION CURB AND GUTTER (ADD ALTERNATE)	—	—
603A		98	L.F.	6" CURB (ADD ALTERNATE)	—	—
					—	—
					—	—
					—	—
					—	—
					—	—
					—	—
					—	—
<b>End Category ADD ALTERNATES</b>					Total This Sheet	

ATTACHMENT 5

# WAREHAM ALLEY

# JONATHAN STREET

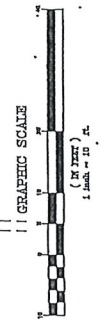
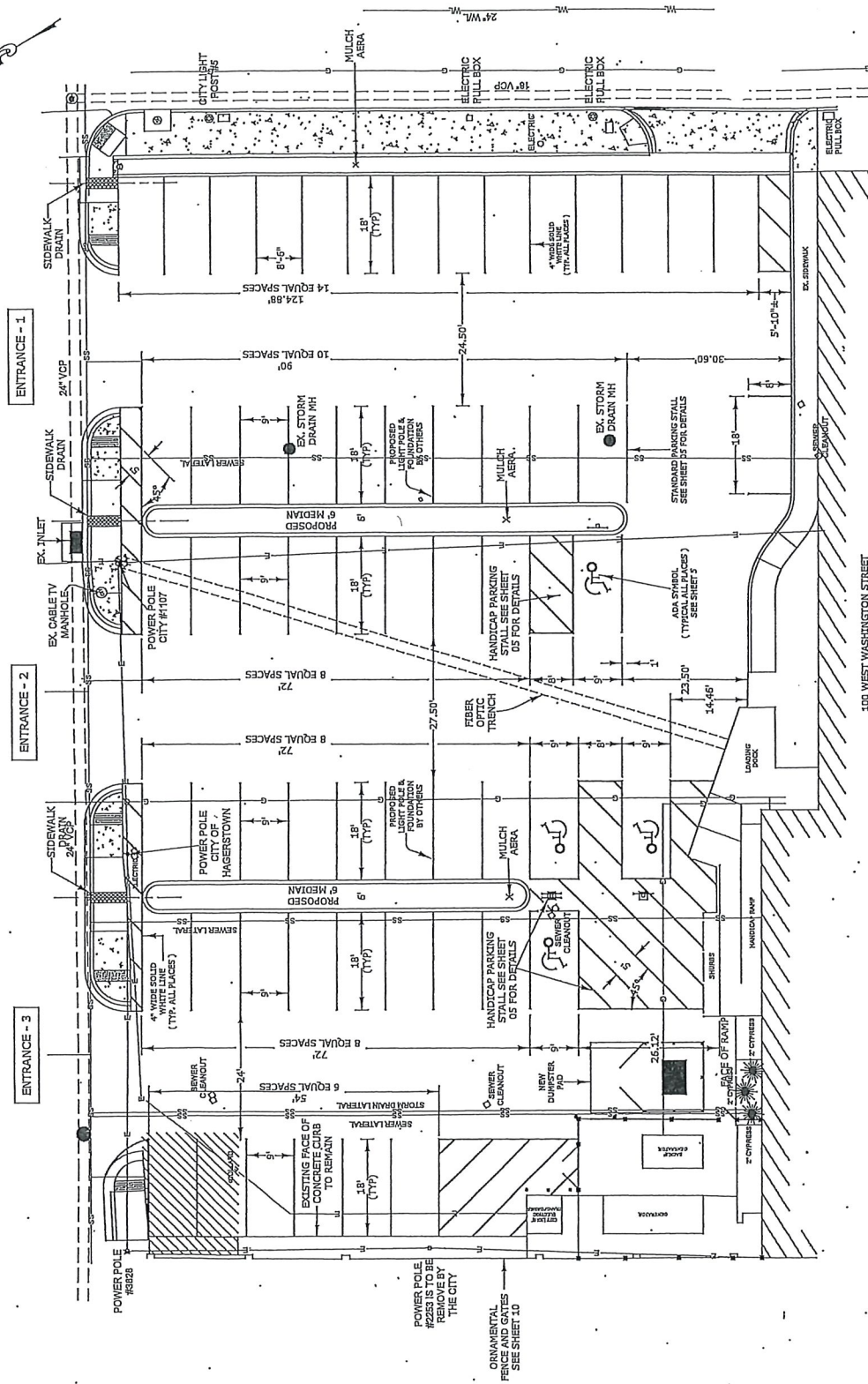
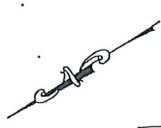

100 WEST WASHINGTON STREET  
WAREHAM ALLEY  
ADMINISTRATION BUILDING

POWER POLE #18223 IS TO BE REMOVED BY THE CITY

ORNAMENTAL FENCE AND GATES SEE SHEET 10

**WAREHAM  
ALLEY**

THE CONTRACTOR IS TO REMOVE 73 SF OF EXISTING CONCRETE SIDEWALK AND 21 LF CONCRETE CURB AND GUTTER. THEN THE CONTRACTOR IS TO CONSTRUCT 58 SF CONCRETE SIDEWALK ( HANDICAP RAMP ) AND 18 LF CONCRETE CURB & GUTTER PER CITY OF HAGERSTOWN PLATES T-041, T-050, T-052, AND T-054. ( SAW CUT, PAVEMENT REMOVAL, AND CONCRETE CURB STREET REPAIR IS INCIDENTAL TO THE CURB & GUTTER PAY ITEM )

THE CONTRACTOR IS TO REMOVE 82 SF OF EXISTING CONCRETE SIDEWALK AND 21 LF CONCRETE CURB AND GUTTER. THEN THE CONTRACTOR IS TO CONSTRUCT 61 SF CONCRETE SIDEWALK ( HANDICAP RAMP ) AND 18 LF CONCRETE CURB & GUTTER PER CITY OF HAGERSTOWN PLATES T-041, T-050, T-052, AND T-054. ( SAW CUT, PAVEMENT REMOVAL, AND CONCRETE CURB STREET REPAIR IS INCIDENTAL TO THE CURB & GUTTER PAY ITEM )

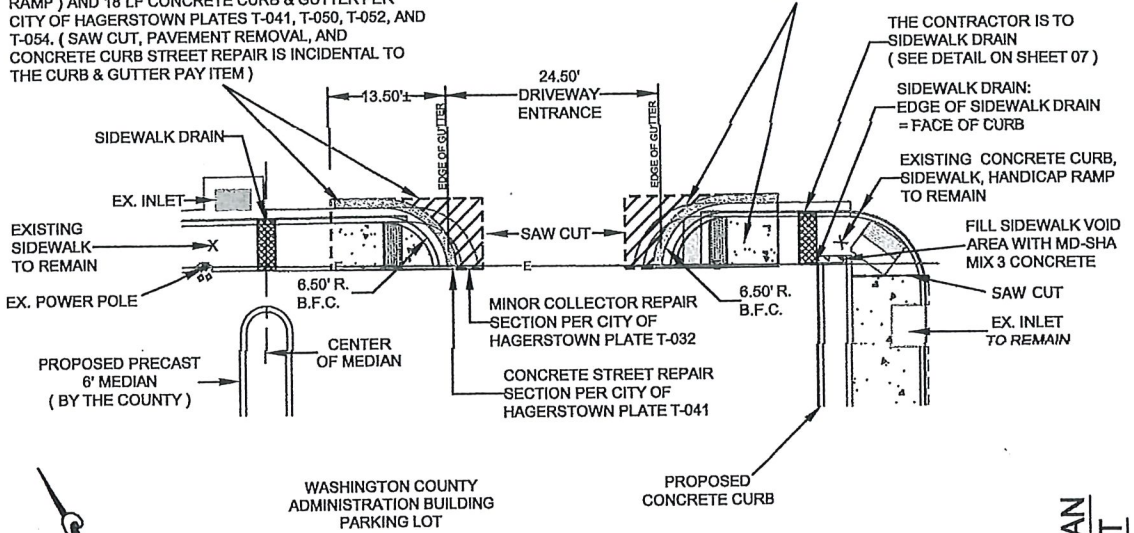

**ENTRANCE - 1**  
SCALE: 1" = 10'  
( BY THE CONTRACTOR )

**WAREHAM  
ALLEY**

THE CONTRACTOR IS TO REMOVE 26 SF OF EXISTING CONCRETE SIDEWALK AND 12 LF CONCRETE CURB AND GUTTER. THEN THE CONTRACTOR IS TO CONSTRUCT 78 SF CONCRETE SIDEWALK ( HANDICAP RAMP ) AND 18 LF CONCRETE CURB & GUTTER PER CITY OF HAGERSTOWN PLATES T-041, T-050, T-052, AND T-054. ( SAW CUT, PAVEMENT REMOVAL, AND CONCRETE CURB STREET REPAIR IS INCIDENTAL TO THE CURB & GUTTER PAY ITEM ).

★ NOTE: THE CONTRACTOR IS TO MAINTAIN THE EXISTING FACE OF CURB ALIGNMENT

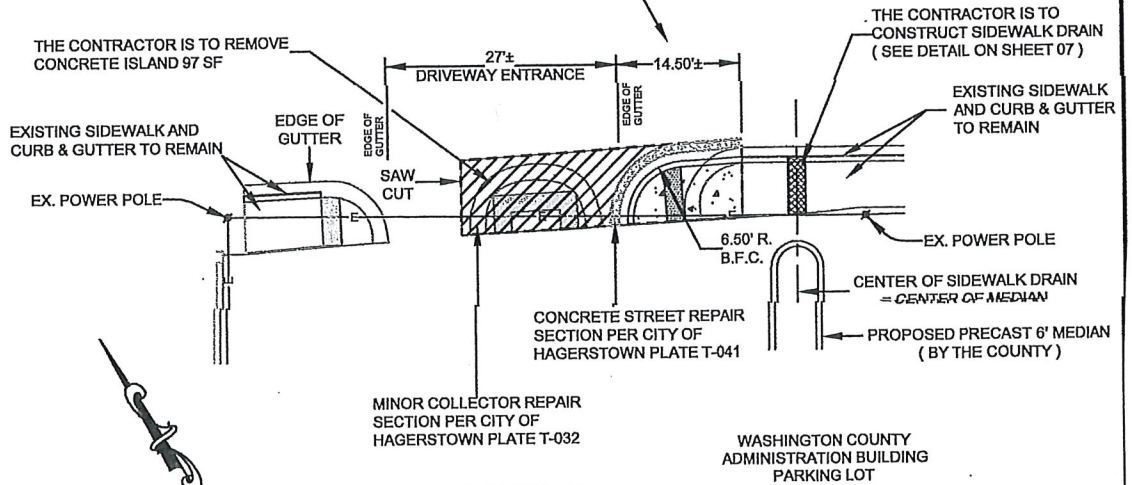

**ENTRANCE - 3**  
SCALE: 1" = 10'  
( BY THE CONTRACTOR )

 = FULL DEPTH PAVING REPAIR

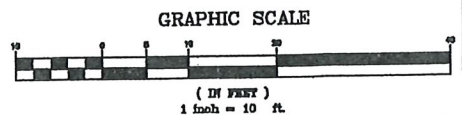



# WAREHAM ALLEY

## ADD ALTERNATE

THE CONTRACTOR IS TO REMOVE 100 LF OF EXISTING CONCRETE CURB.

THE CONTRACTOR IS TO CONSTRUCT 125 LF CONCRETE CURB PER CITY STD. PLATE T-042 / T-044. (SAW CUT AND PAVEMENT REPAIR IS INCIDENTAL TO THE CONCRETE CURB PAY ITEM)

## ADD ALTERNATE

125 LF - 27 LF = 98 LF

THE CONTRACTOR IS TO CONSTRUCT 27 LF CONCRETE CURB PER CITY STD. PLATE T-044. (SAW CUT AND PAVEMENT REPAIR IS INCIDENTAL TO THE CONCRETE CURB PAY ITEM).

WASHINGTON COUNTY  
ADMINISTRATION BUILDING  
PARKING LOT

NORTH SIDE  
FACE OF  
BUILDING

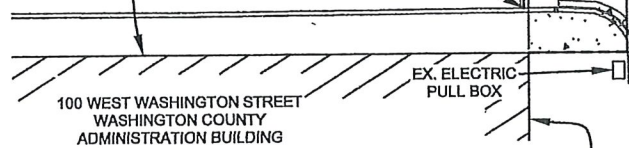

## DRIVEWAY ENTRANCE CLOSURE

SCALE: 1" = 10'

EAST SIDE  
FACE OF  
BUILDING

JONATHAN STREET

# WAREHAM ALLEY

THE CONTRACTOR IS TO REMOVE 143 SF CONCRETE SIDEWALK AND 31 LF CONCRETE CURB AND GUTTER. THEN THE CONTRACTOR IS TO CONSTRUCT 57 SF CONCRETE SIDEWALK (HANDICAP RAMP) AND 16 LF CONCRETE CURB & GUTTER PER CITY OF HAGERSTOWN PLATES T-041, T-050, T-052, AND T-054. (SAW CUT, PAVEMENT REMOVAL, AND CONCRETE CURB STREET REPAIR IS INCIDENTAL TO THE CURB & GUTTER PAY ITEM)

THE CONTRACTOR IS TO REMOVE 42 SF OF EXISTING CONCRETE SIDEWALK AND 13 LF CONCRETE CURB AND GUTTER. THEN THE CONTRACTOR IS TO CONSTRUCT 50 SF CONCRETE SIDEWALK (HANDICAP RAMP) AND 18 LF CONCRETE CURB & GUTTER PER CITY OF HAGERSTOWN PLATES T-041, T-050, T-052, AND T-054. (SAW CUT, PAVEMENT REMOVAL, AND CONCRETE CURB STREET REPAIR IS INCIDENTAL TO THE CURB & GUTTER PAY ITEM)

NOTE: THE CONTRACTOR IS TO MAINTAIN THE EXISTING FACE OF CURB ALIGNMENT

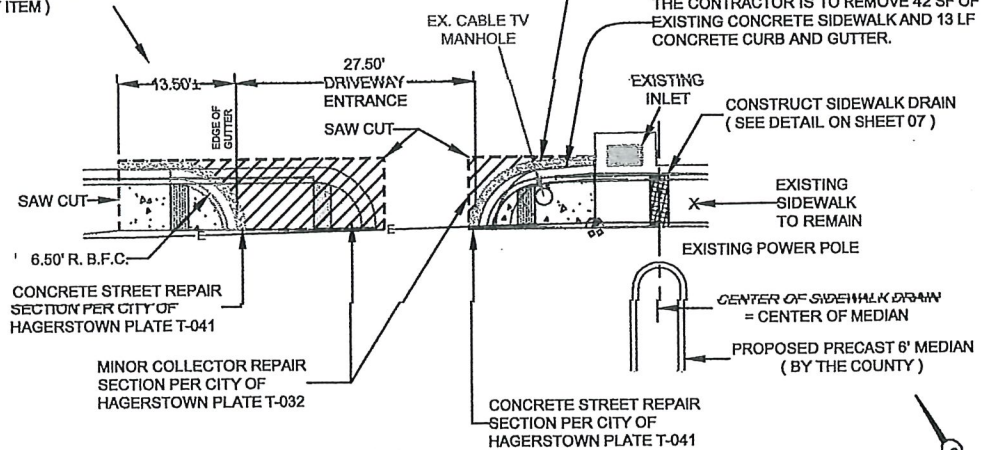

WASHINGTON COUNTY  
ADMINISTRATION BUILDING  
PARKING LOT

## ENTRANCE - 2

SCALE: 1" = 10'

( BY THE CONTRACTOR )

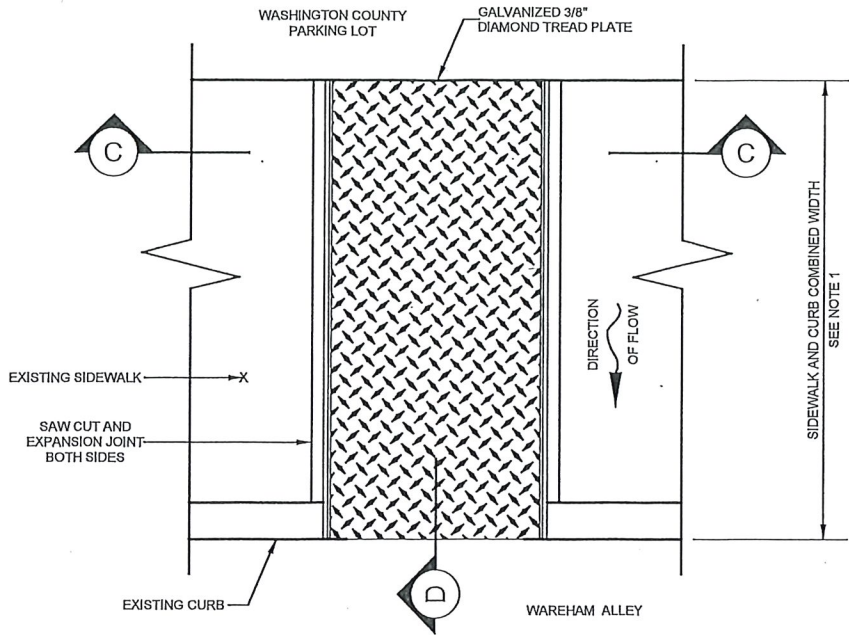

SIDEWALK DRAIN TOP VIEW  
NTS

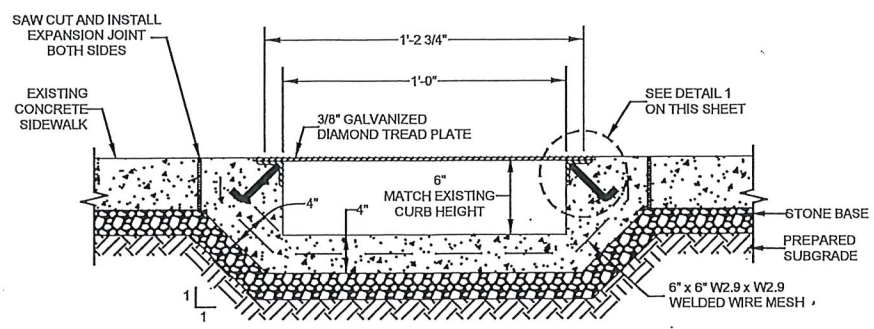

SECTION - "C" - "C"  
NTS

- NOTES:  
1. THE SIDEWALK DRAIN SHALL MATCH EXISTING SIDEWALK AND CURB COMBINED WIDTH.

SIDEWALK DRAIN DETAIL  
NTS

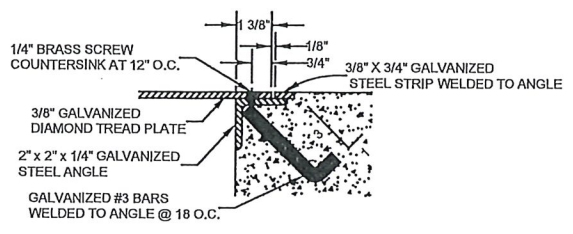

DETAIL - 1  
NTS

EXPANSION JOINT:  
1/2" EXPANSION JOINT TO ALLOW FOR  
TWO PART ELASTOMERIC GUN-GRADE  
POLYSULFIDE SEALANT, SONNEBORN  
SONOLASTIC, OR EQUAL

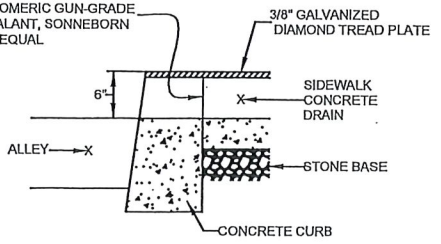

SECTION - "D"  
NTS

**NOTES**

- REPLACEMENT CURB & GUTTER SHALL BE INSTALLED IF CURB & GUTTER CURRENTLY EXISTS OR CURB CURRENTLY EXISTS AND THE EXISTING GUTTER FLOW LINE PERCENT SLOPE IS LESS THAN 1.0%. OBTAIN A CITY OF HAGERSTOWN, MARYLAND CURB & GUTTER REPLACEMENT PERMIT AND CONTACT MISS UTILITY (1-800-257-7777) BEFORE STARTING DEMOLITION. CONCRETE FOR REPLACEMENT CURB & GUTTER AND FOR THE STREET REPAIR SHALL BE MD DEPT. OF TRANS. S.H.A. MIX NO. 3 WITH A 28 DAY COMPRESSIVE STRENGTH OF 3,500 P.S.I., WITH 5%-8% AIR AND 2"-5" SLUMP. DO NOT ADD WATER TO THE SURFACE FOR FINISHING. ALL CONCRETE SHALL BE THOROUGHLY VIBRATED IN PLACE AND ALL EXPOSED SURFACES SHALL HAVE A BROOM FINISH. REPLACEMENT JOINTS SHALL RECEIVE 3" MIN. MD DEPT. OF TRANS. S.H.A. NO. 57 STONE BEDDING. 1/2" EXPANSION JOINTS SHALL BE INSTALLED AT 40' MAX. INTERVALS, SAW CUT JOINTS AT 10' MAX. INTERVALS (JOINTS IN SIDEWALK AND IN CURB & GUTTER TO MATCH WHERE POSSIBLE). SIDEWALK AND CURB & GUTTER SHALL NEVER BE PLACED MONOLITHIC. NOTIFY THE CITY OF HAGERSTOWN, ENGINEERING & INSPECTIONS DEPARTMENT IN ADVANCE OF THE PLACEMENT OF ANY CONCRETE OR BITUMINOUS CONCRETE. REFER TO PLATE T-040 NOTE NO. 1 FOR SEALANT REQUIREMENTS.
- SAW CUT THE EXISTING STREET PAVEMENT IN NEAT STRAIGHT LINES AT 12" MAXIMUM FROM THE EDGE OF GUTTER PAN, (18" MAXIMUM FROM EDGE OF GUTTER PAN IF THERE IS NO GRASS PLOT).
- THE CONCRETE STREET REPAIR SHALL BE PLACED ONLY AFTER THE REPLACEMENT CURB & GUTTER CONCRETE HAS BEEN PLACED AND HAS CURED, (IN NO CASE SHALL THE TWO BE PLACED MONOLITHIC).
- THE CONCRETE STREET REPAIR SHALL HAVE A RAKED SURFACE AND RECEIVE TACK COAT BEFORE THE PLACEMENT OF THE 1 1/2" TO 2" DEPTH BITUMINOUS CONCRETE STREET REPAIR.
- IF THE REPLACEMENT CURB & GUTTER IS HIGHER THAN THE EXISTING CURB/GUTTER & GUTTER IT TIES INTO, A TRANSITION REPLACEMENT CURB & GUTTER SHALL BE INSTALLED. THE LENGTH OF THIS TRANSITION CURB & GUTTER SHALL BE 12 INCHES FOR EVERY 1 INCH OF DIFFERENCE IN HEIGHT BETWEEN THE REPLACEMENT AND THE EXISTING. THIS TRANSITION CURB & GUTTER SHALL BE CENTERED ON THE PROPERTY LINE SUCH THAT HALF IS ON THE ADJACENT PROPERTY. INSTALL A 1/2" EXPANSION JOINT AS SHOWN. IF THE ADJACENT PROPERTY HAS EXISTING TRANSITION CURB & GUTTER, REMOVE IT TO THE EXPANSION JOINT AND INSTALL REPLACEMENT CURB & GUTTER TO COMPLETELY REPLACE IT.
- ALL DISTURBED AREAS SHALL RECEIVE A MINIMUM OF 4" OF TOPSOIL AND MD DEPT. OF TRANS. S.H.A. MIX NO. 1 SEED, AND MULCH.

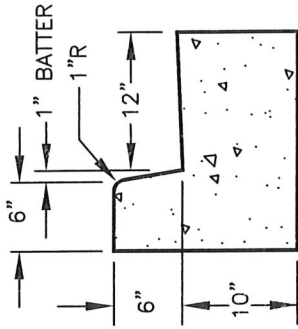

**REPLACEMENT CURB & GUTTER**

SECTION VIEW

STREET REPAIR, MD  
S.H.A. MIX NO. 3  
CONCRETE WITH  
RAKED SURFACE

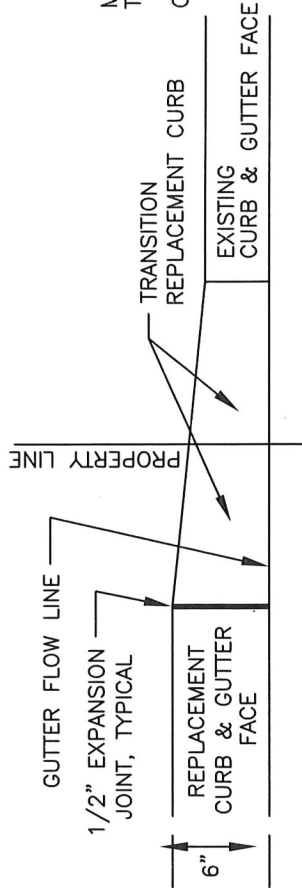

**TYPICAL TRANSITION, REPLACEMENT CURB & GUTTER**

ELEVATION VIEW

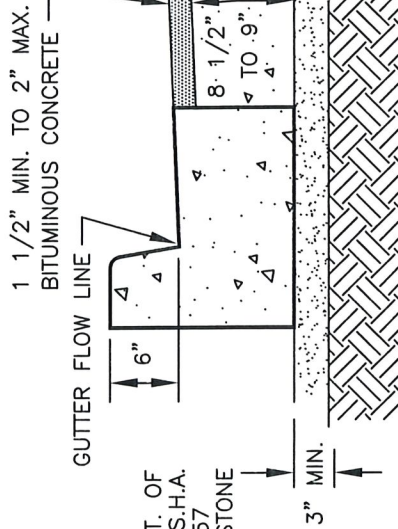

**REPLACEMENT CURB & GUTTER INSTALLATION**

SECTION VIEW

CITY OF HAGERSTOWN, MARYLAND - ENGINEERING AND INSPECTIONS DEPARTMENT

TRANSPORTATION STANDARD DETAIL  
REPLACEMENT CURB AND GUTTER



ISSUE DATE: 01-01-03

REVISIONS

01-01-07

Plate T-041

**NOTES**

1. REPLACEMENT CURB SHALL ONLY BE ALLOWED IF CURB EXISTS CURRENTLY (NOT CURB & GUTTER) AND THE EXISTING GUTTER FLOW LINE PERCENT SLOPE IS GREATER THAN 1.0%. OBTAIN A CITY OF HAGERSTOWN, MARYLAND CURB REPLACEMENT PERMIT AND CONTACT MISS UTILITY (1-800-257-7777) BEFORE PROCEEDING WITH DEMOLITION.
2. CONCRETE FOR REPLACEMENT CURB AND FOR THE STREET REPAIR SHALL BE MD DEPT. OF TRANS. S.H.A. MIX NO. 3 WITH A 28 DAY COMPRESSIVE STRENGTH OF 3,500 P.S.I., WITH 5%-8% AIR AND 2"-5" SLUMP. DO NOT ADD WATER TO THE SURFACE FOR FINISHING. ALL CONCRETE SHALL BE THOROUGHLY VIBRATED IN PLACE AND ALL EXPOSED SURFACES SHALL HAVE A BROOM FINISH. REPLACEMENT CURB & GUTTER SHALL RECEIVE 3" MIN. MD DEPT. OF TRANS. S.H.A. NO. 57 STONE BEDDING. 1/2" EXPANSION JOINTS SHALL BE INSTALLED AT 40' MAX. INTERVALS, SAW CUT JOINTS AT 10' MAX. INTERVALS (JOINTS IN SIDEWALK AND IN CURB & GUTTER TO MATCH WHERE POSSIBLE). SIDEWALK AND CURB SHALL NEVER BE PLACED MONOLITHIC. NOTIFY THE CITY OF HAGERSTOWN, ENGINEERING & INSPECTIONS DEPARTMENT IN ADVANCE OF THE PLACEMENT OF ANY CONCRETE OR BITUMINOUS CONCRETE. REFER TO PLATE T-040 NOTE NO. 1 FOR SEALANT REQUIREMENTS.
3. SAW CUT THE EXISTING STREET PAVEMENT IN NEAT STRAIGHT LINES AT 12" MAXIMUM FROM THE FACE OF THE CURB, (18" MAXIMUM FROM FACE OF CURB IF THERE IS NO GRASS PLOT).
4. THE CONCRETE STREET REPAIR SHALL BE PLACED ONLY AFTER THE REPLACEMENT CURB CONCRETE HAS BEEN PLACED AND HAS CURED. (IN NO CASE SHALL THE TWO BE PLACED MONOLITHIC).
5. THE CONCRETE STREET REPAIR SHALL HAVE A RAKED SURFACE AND RECEIVE TACK COAT BEFORE THE PLACEMENT OF THE 1 1/2" TO 2" DEPTH BITUMINOUS CONCRETE STREET REPAIR.
6. IF THE REPLACEMENT CURB IS HIGHER THAN THE EXISTING CURB IT TIES INTO, A TRANSITION REPLACEMENT CURB SHALL BE INSTALLED. THE LENGTH OF THIS TRANSITION CURB SHALL BE 12 INCHES FOR EVERY 1 INCH OF DIFFERENCE IN HEIGHT BETWEEN THE REPLACEMENT CURB AND THE EXISTING CURB. THIS TRANSITION CURB SHALL BE CENTERED ON THE PROPERTY LINE SUCH THAT HALF IS ON THE ADJACENT PROPERTY. INSTALL A 1/2" EXPANSION JOINT AS SHOWN. IF THE ADJACENT PROPERTY HAS EXISTING TRANSITION CURB, REMOVE IT TO THE EXPANSION JOINT. INSTALL REPLACEMENT CURB TO COMPLETELY REPLACE IT.
7. ALL DISTURBED AREAS SHALL RECEIVE A MINIMUM OF 4" OF TOPSOIL AND MD DEPT. OF TRANS. S.H.A. MIX NO. 1 SEED, AND MULCH.

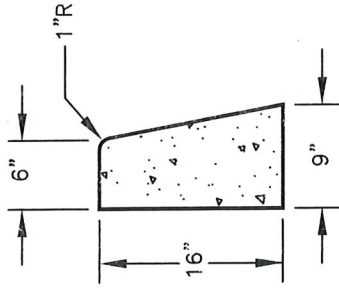

**REPLACEMENT CURB**

SECTION VIEW

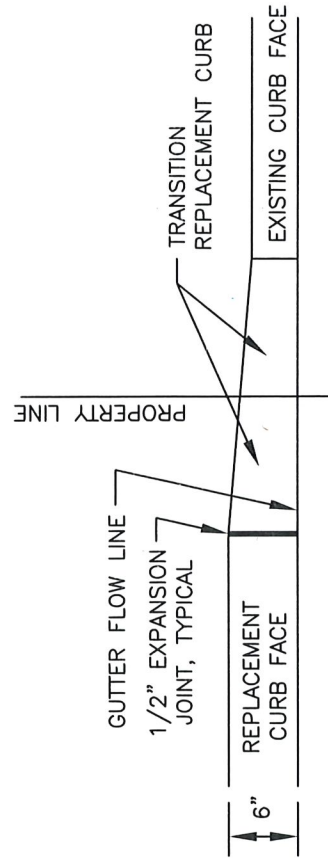

**REPLACEMENT CURB, TYPICAL TRANSITION**

ELEVATION VIEW

STREET REPAIR, MD  
S.H.A. MIX NO. 3  
CONCRETE WITH  
RAKED FINISH

1 1/2" MIN. TO 2" MAX.  
BITUMINOUS CONCRETE

GUTTER FLOW LINE

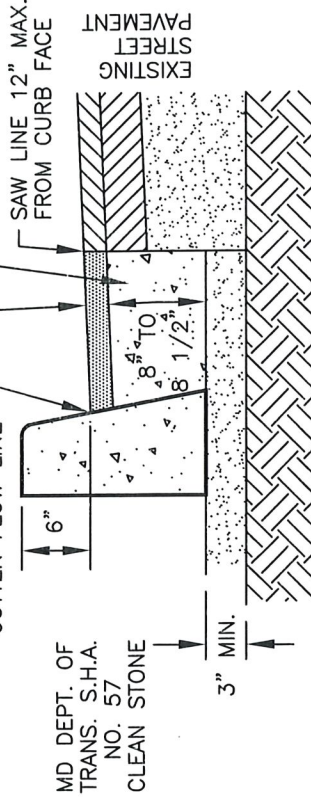

**REPLACEMENT CURB INSTALLATION**

SECTION VIEW

	CITY OF HAGERSTOWN, MARYLAND - ENGINEERING AND INSPECTIONS DEPARTMENT	
	TRANSPORTATION STANDARD DETAIL REPLACEMENT CURB	
ISSUE DATE: 01-01-03		REVISIONS
01-01-07		
Plate		T-042
© CITY OF HAGERSTOWN, MD, 2007		

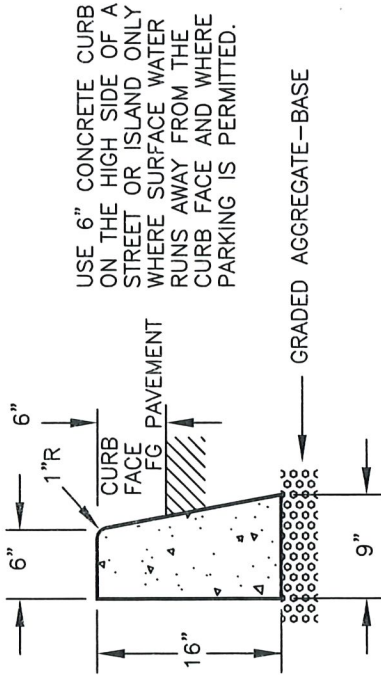

USE 6" CONCRETE CURB ON THE HIGH SIDE OF A STREET OR ISLAND ONLY WHERE SURFACE WATER RUNS AWAY FROM THE CURB FACE AND WHERE PARKING IS PERMITTED.

GRADED AGGREGATE-BASE

**6" CONCRETE CURB**

SECTION VIEW

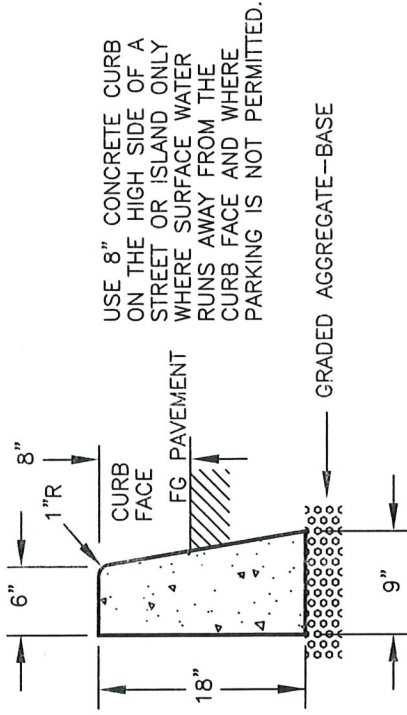

USE 8" CONCRETE CURB ON THE HIGH SIDE OF A STREET OR ISLAND ONLY WHERE SURFACE WATER RUNS AWAY FROM THE CURB FACE AND WHERE PARKING IS NOT PERMITTED.

GRADED AGGREGATE-BASE

**8" CONCRETE CURB**

SECTION VIEW

**NOTES**

1. CONCRETE CURB AND GUTTER SHALL BE THE STANDARD FOR ALL NEW STREET CONSTRUCTION. CONCRETE CURB MAY BE INSTALLED AT LOCATIONS APPROVED BY THE CITY ENGINEER ONLY. USE 6" CONCRETE CURB ON THE HIGH SIDE OF A STREET OR ISLAND ONLY WHERE SURFACE WATER RUNS AWAY FROM THE CURB FACE AND WHERE PARKING IS PERMITTED. USE 8" CONCRETE CURB ON THE HIGH SIDE OF A STREET OR ISLAND ONLY WHERE SURFACE WATER RUNS AWAY FROM THE CURB FACE AND WHERE PARKING IS NOT PERMITTED.
2. ALL CONCRETE FOR CURB SHALL BE MD DEPT. OF TRANS. S.H.A. MIX NO. 3 WITH A 28 DAY COMPRESSIVE STRENGTH OF 3,500 P.S.I., AND SHALL HAVE AIR ENTRAINMENT OF 5%-8% AND 2"-5" SLUMP. ALL EXPOSED SURFACES SHALL HAVE A BROOM FINISH. SAW CUT JOINTS WILL BE INSTALLED AT 10' MAXIMUM INTERVALS AND 1" EXPANSION JOINTS AT 40' MAXIMUM INTERVALS (80' MAX FOR EXTRUDED CURB). EXPANSION JOINT MATERIAL WILL BE POSITIONED TO ALLOW FOR THE REQUIRED 1/2" DEPTH TWO PART ELASTOMERIC GUN-GRADE POLYSULFIDE SEALANT, SONNEBORN SONOLASTIC OR AN APPROVED EQUAL. SAW CUT JOINTS WILL ALSO RECEIVE THIS SEALANT, BUT AT A 3/8" DEPTH.
3. EXCAVATED SUBGRADE SHALL BE UNDISTURBED EARTH, OR SHALL BE COMPACTED TO RECEIVE GRADED AGGREGATE-BASE STONE BED. ALL GRADED AGGREGATE-BASE SHALL BE COMPACTED BY MECHANICAL MEANS TO A MINIMUM OF 95% OF THE MAXIMUM DRY DENSITY OF THE MODIFIED PROCTOR (ASTM D1557-78, OR AASHTO T-180) WITH AN IN PLACE MOISTURE CONTENT OF APPROXIMATELY ±2% OF THE OPTIMUM MOISTURE CONTENT. THE CONTRACTOR SHALL DRY OR WET SOIL TO ACHIEVE SATISFACTORY RESULTS, INCIDENTAL TO THIS ITEM.



CITY OF HAGERSTOWN, MARYLAND - ENGINEERING AND INSPECTIONS DEPARTMENT

**TRANSPORTATION STANDARD DETAIL  
CONCRETE CURB  
FOR NEW STREET CONSTRUCTION**

ISSUE DATE: 01-01-07

REVISIONS

Plate **T-044**

**NOTES**

1. CONCRETE FOR STANDARD SIDEWALK SHALL BE MD DEPT. OF TRANS. S.H.A. MIX NO. 3 WITH A 28 DAY COMPRESSIVE STRENGTH OF 3,500 P.S.I., WITH 5%-8% AIR ENTRAINMENT AND 2"-5" SLUMP. ALL EXPOSED SURFACES SHALL RECEIVE A LIGHT TRANSVERSE BROOM FINISH. DO NOT ADD WATER TO THE SURFACE FOR FINISHING. ALL STANDARD SIDEWALK SHALL BE 5'-0" WIDE BY 4" DEEP AND SHALL BE PLACED ON A BED OF 4" MIN. DEPTH MD DEPT. OF TRANS. S.H.A. NO. 57 CLEAN STONE. TRANSVERSE 1/2" BITUMINOUS EXPANSION JOINTS SHALL BE PLACED AT INTERVALS OF 40 FEET AT THE EXPANSION JOINT LOCATION IN THE CURB AND GUTTER. TOOLED TRANSVERSE JOINTS SHALL BE INSTALLED EVERY 5 FEET SO AS TO CREATE SIDEWALK SQUARES AND EVENLY DIVIDE THE 40 FEET BETWEEN THE EXPANSION JOINTS. EXPANSION JOINT MATERIAL WILL BE POSITIONED TO ALLOW FOR THE REQUIRED 1/2" DEPTH TWO PART ELASTOMERIC GUN-GRADE POLYSULFIDE SEALANT, SONNEBORN SONOLASTIC OR AN APPROVED EQUAL. SAW CUT JOINTS WILL ALSO RECEIVE THIS SEALANT, BUT AT A 3/8" DEPTH. COVER ALL SEALANT WITH FINE SAND TO REDUCE TRACKING.
2. ALL CITY OF HAGERSTOWN, MD STANDARD CONCRETE SIDEWALK SHALL BE CONSTRUCTED IN COMPLIANCE WITH THE "AMERICANS WITH DISABILITIES ACT" (A.D.A.) REQUIREMENTS. REFER TO SECTION 4.3 FOR INFORMATION CONCERNING "ACCESSIBLE ROUTE".
3. ALL GRASS AREAS ADJACENT TO THE CONCRETE SIDEWALK SHALL RECEIVE 4" MINIMUM DEPTH OF TOPSOIL AND MD DEPT. OF TRANS. S.H.A. MIX NO. 1 GRASS SEED, AND MULCH.
4. NO. 57 STONE SHALL BE AGITATED, VIBRATED, OR OTHERWISE SETTLED IN PLACE. GRADED AGGREGATE-BASE SHALL BE COMPACTED BY MECHANICAL MEANS TO A MINIMUM OF 92% OF THE MAXIMUM DRY DENSITY OF THE MODIFIED PROCTOR (ASTM D1557-78, OR AASHTO T-180) WITH AN IN PLACE MOISTURE CONTENT OF APPROXIMATELY ±2% OF THE OPTIMUM MOISTURE CONTENT.
5. PROVIDE 4:1 SLOPES OR FLATTER IN "CITY LIGHT" EASEMENTS.

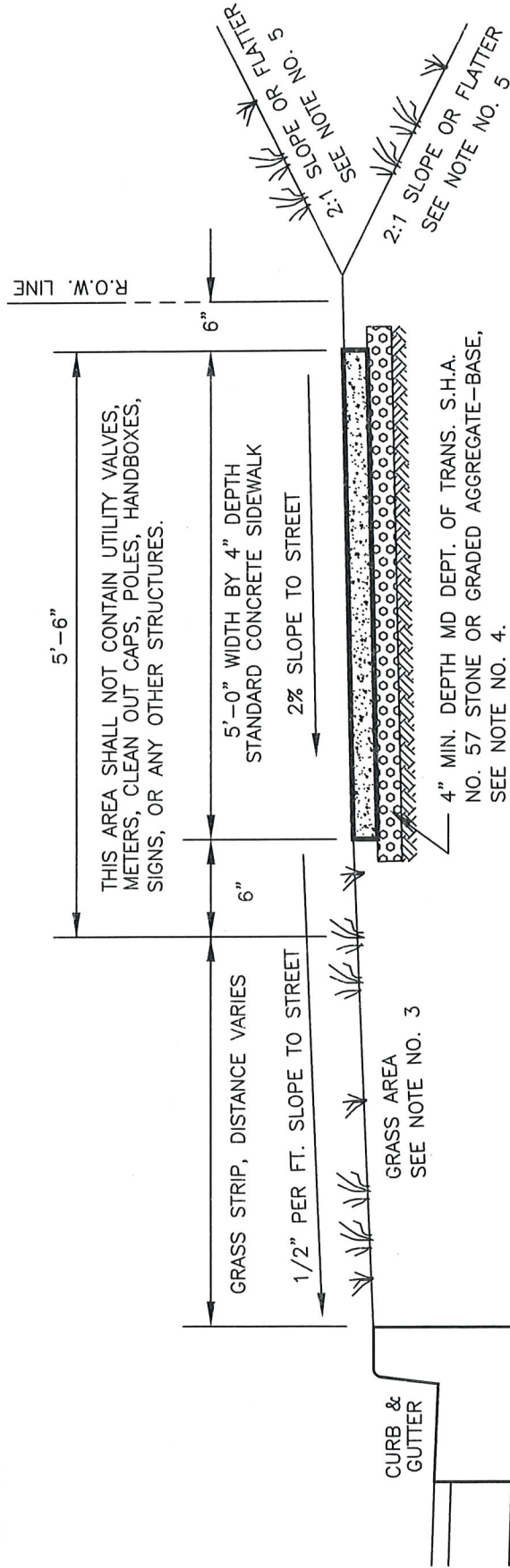

**STANDARD SIDEWALK SECTION VIEW**



CITY OF HAGERSTOWN, MARYLAND - ENGINEERING AND INSPECTIONS DEPARTMENT

TRANSPORTATION STANDARD DETAIL  
STANDARD CONCRETE SIDEWALK  
FOR NEW STREET CONSTRUCTION

ISSUE DATE: 01-01-03

REVISIONS

01-01-07

Plate T-050

## NOTES

1. ALL REPLACEMENT CONCRETE SIDEWALK SHALL BE MD DEPT. OF TRANS. S.H.A. MIX NO. 3 WITH A 28 DAY COMPRESSIVE STRENGTH OF 3,500 P.S.I. WITH 5%-8% AIR AND 2"-5" SLUMP, PLACED AT 4" MINIMUM THICKNESS. THE EXPOSED SURFACE SHALL BE BROOM FINISHED. DO NOT ADD WATER TO THE SURFACE FOR FINISHING. CONCRETE SHALL BE PLACED ON 4" MINIMUM DEPTH MD DEPT. OF TRANS. S.H.A. NO. 57 STONE ON FIRM SUBGRADE.
2. THE REPLACEMENT CONCRETE SIDEWALK'S LOCATION, DIMENSIONS, JOINT PATTERN, JOINT TYPES, "BOX OUTS" FOR STRUCTURES, ETC. SHALL BE CONSTRUCTED AS DIRECTED BY THE CITY INSPECTOR. THE CITY INSPECTOR SHALL BE NOTIFIED IN ADVANCE OF ANY CONCRETE PLACEMENT. OBTAIN A CITY OF HAGERSTOWN, MD SIDEWALK REPLACEMENT PERMIT AND CONTACT MISS UTILITY (1-800-257-7777) BEFORE PROCEEDING WITH DEMOLITION OR CONSTRUCTION.
3. IF THE REPLACEMENT SIDEWALK IS REQUIRED TO BE RAISED IN ELEVATION FROM ITS PREVIOUS ELEVATION, TRANSITION REPLACEMENT SIDEWALK MAY BE REQUIRED. THIS TRANSITION SIDEWALK SHALL BE CENTERED ON THE PROPERTY LINE WITH THE ADJACENT PROPERTY AND SHALL BE 12 INCHES IN LENGTH FOR EVERY 1 INCH OF ELEVATION CHANGE OR FLATTER AS DIRECTED BY THE CITY INSPECTOR.
4. REPLACEMENT SIDEWALK AND REPLACEMENT CURB SHALL NOT BE MONOLITHIC. CONCRETE FOR THE REPLACEMENT SIDEWALK SHALL BE PLACED SEPARATELY FROM THE CONCRETE FOR THE REPLACEMENT CURB.
5. TRANSVERSE 1/2" EXPANSION JOINTS SHALL BE REQUIRED AT 40' MAXIMUM INTERVALS AND SHALL ALSO BE PLACED ALONG THE BACK SIDE OF CURB WHERE SIDEWALK IS CONFINED BY CURB ON ONE EDGE AND STRUCTURES ON THE OTHER EDGE. EXPANSION JOINT MATERIAL WILL BE POSITIONED TO ALLOW FOR THE REQUIRED 1/2" DEPTH TWO PART ELASTOMERIC GUN-GRADE POLYSULFIDE SEALANT, SONNEBORN SONOLASTIC OR APPROVED EQUAL.
6. WHEN SIGN POSTS EXIST IN THE SIDEWALK (TO BE REMOVED AND REPLACED) A 4" DIAMETER SCH 40 PVC SLEEVE MUST BE INSTALLED FOR EACH POST AT ITS FORMER LOCATION, UNLESS OTHERWISE DIRECTED BY THE CITY INSPECTOR. IF PARKING METERS EXIST IN SIDEWALK TO BE REPLACED CONTACT THE CITY PARKING METER TECHNICIAN AT CITY HALL TO MAKE ARRANGEMENTS TO HAVE THE METER HEAD REMOVED AND STORED BY THE CITY TECHNICIAN (CALL AGAIN TO ARRANGE REPLACING OF THE METER HEAD).
7. ALWAYS PROVIDE 36" MINIMUM "CLEAR WIDTH" ON SIDEWALKS IN COMPLIANCE WITH A.D.A. REQUIREMENTS.

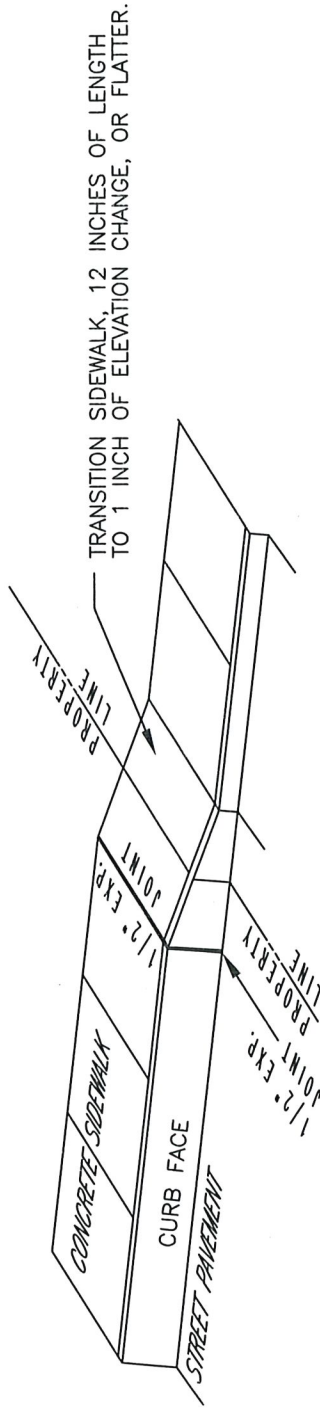

CITY OF HAGERSTOWN, MARYLAND - ENGINEERING AND INSPECTIONS DEPARTMENT

## TRANSPORTATION STANDARD DETAIL REPLACEMENT CONCRETE SIDEWALK

ISSUE DATE: 01-01-03

REVISIONS

01-01-07

Plate **T-052**

**NOTES**

1. THE LOCATION OF THE TYPE 2 SIDEWALK RAMP SHALL BE DETERMINED BY CURRENT A.D.A. REQUIREMENTS, EXISTING OBSTRUCTIONS, CROSSWALK LOCATION, THE SIDEWALK ALIGNMENT, AND SHALL BE APPROVED BY THE CITY ENGINEER BEFORE CONSTRUCTION BEGINS.
2. THE EDGE OF THE CONCRETE RAMP APRONS SHALL START AT THE BEGINNING OF THE TRANSITION CURB AND EXTEND TO THE END OF THE 6" CONCRETE RAMP. APRONS SHALL BE 6" THICK CONCRETE REINFORCED THE SAME AS THE RAMP.
3. ALL CONCRETE SHALL BE MD DEPT. OF TRANS. S.H.A. MIX NO. 3 WITH A 28 DAY COMPRESSIVE STRENGTH OF 3,500 P.S.I., WITH 5%-8% AIR AND 2"-5" SLUMP. DO NOT ADD WATER TO THE SURFACE FOR FINISHING. ALL EXPOSED SURFACES SHALL RECEIVE A LIGHT TRANSVERSE BROOM FINISH.
4. REFER TO PLATE T-050 FOR STANDARD CONCRETE SIDEWALK, AND PLATE T-042 FOR CONCRETE REPLACEMENT CURB.
5. THE DOT HATCHED AREA REPRESENTS A DETECTABLE WARNING SURFACE AT THE REQUIRED LOCATION AND ORIENTATION. REFER TO PLATE T-059 FOR THE DETECTABLE WARNING SURFACE SYSTEM SPECIFICATIONS, DETAILS, AND NOTES.

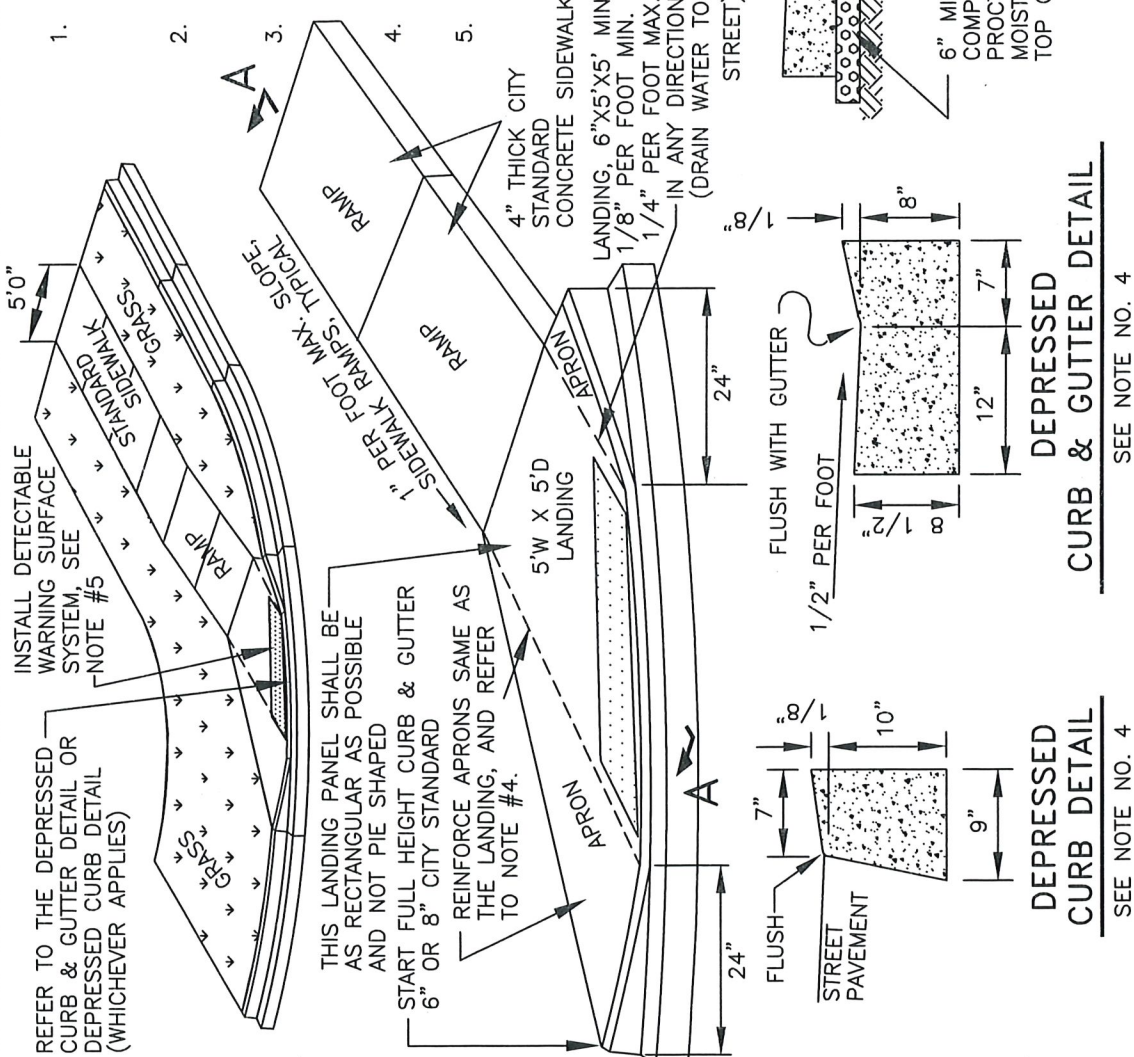

ISSUE DATE: 03-01-2018
REVISIONS
-----
<b>PLATE T-054</b>

CITY OF HAGERSTOWN, MARYLAND - ENGINEERING DIVISION

TRANSPORTATION STANDARD DETAIL  
SIDEWALK RAMP TYPE 2

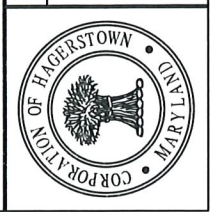



## GENERAL NOTES

1. THE PEDESTRIAN WARNING SURFACE SYSTEM SHALL CONFORM TO THE LATEST AMERICANS WITH DISABILITIES ACT (ADA) GUIDELINES FOR OUTDOOR FACILITIES. THE CONTRACTOR SHALL USE THE POLYMER COMPOSITE EMBEDMENT PANEL BY ADA SOLUTIONS, INC. OR CITY ENGINEER APPROVED EQUAL. STAMPING OF CONCRETE TO CREATE WARNING DOMES SHALL NOT BE PERMITTED. THE CONTRACTOR SHALL SUBMIT THE SOURCE OF THE PROPOSED SYSTEM TO THE ENGINEER FOR APPROVAL.
2. THE DETECTABLE WARNING SURFACE SHALL BE 24" WIDE WITH LENGTH AND ORIENTATION AS SHOWN ON EACH PEDESTRIAN RAMP STANDARD DETAIL. THE SYSTEM SHALL CONSIST OF A SURFACE OF TRUNCATED DOMES ALIGNED IN A SQUARE GRID PATTERN AS SHOWN. THE COLOR OF THE SURFACE SHALL MATCH FEDERAL COLOR NUMBER YELLOW 33538. THE SURFACES SHALL HAVE A MINIMUM COEFFICIENT OF FRICTION OF 0.8 WHEN TESTED PER ASTM C 1028.
3. THE PEDESTRIAN WARNING SYSTEM SHALL BE INLAID. THE CONTRACTOR SHALL INSTALL THE SYSTEM IN CONFORMANCE WITH THE MANUFACTURER'S RECOMMENDATIONS. THESE RECOMMENDATIONS SHALL ADDRESS THE CONDITIONS OF THE CONCRETE SURFACE ON WHICH THE SYSTEM WILL BE APPLIED: SURFACE FINISH, PRESENCE OF CURING COMPOUND, LENGTH OF CURE, ETC. THE RECOMMENDATIONS SHALL ALSO ADDRESS AMBIENT TEMPERATURE, MOISTURE CONDITIONS, ADHESIVE POT LIFE, SET TIME, TOOLS REQUIRED, AND OTHER DETAILS ABOUT THE TECHNIQUE OF THE SYSTEM INSTALLATION.
4. THE VERTICAL EDGE OF THE INSTALLED SYSTEM SHALL BE NO HIGHER THAN 0.25" ABOVE THE ADJACENT SURFACES. WHEN THE DIFFERENCE IN HEIGHT IS GREATER THAN 0.25" THE CONTRACTOR SHALL BEVEL THE EDGES WITH A SLOPE NO STEEPER THAN 1:2.
5. FOR SKEWED APPLICATIONS, DETECTABLE WARNING SURFACE SHALL BE PLACED SUCH THAT THE DOMES CLOSEST TO THE BACK OF CURB ARE NO LESS THAN 0.5" AND NO MORE THAN 3.0" FROM THE BACK OF CURB. TRUNCATED DOME SURFACES SHALL BE FABRICATED TO PROVIDE FULL DOMES ONLY.

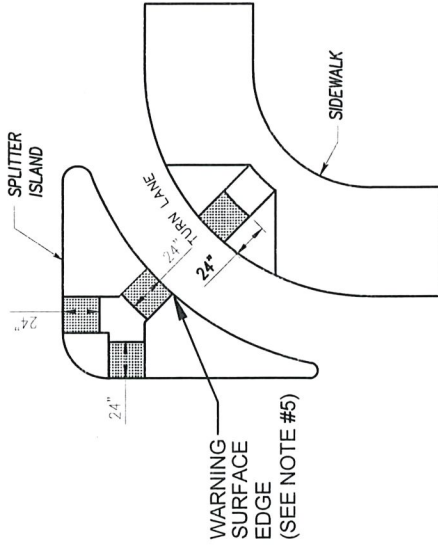

### REFUGE ISLAND

WHERE ISLANDS OR MEDIANS ARE LESS THAN 6 FEET WIDE, THE DETECTABLE WARNING SHOULD EXTEND ACROSS THE FULL LENGTH OF THE CUT THROUGH THE ISLAND OR MEDIAN

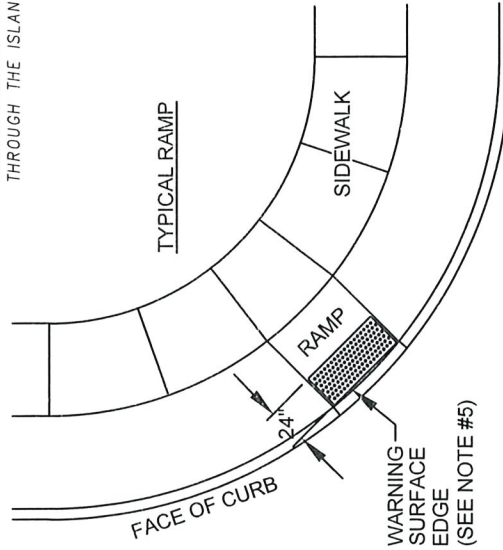

CITY OF HAGERSTOWN, MARYLAND - ENGINEERING DIVISION

## TRANSPORTATION STANDARD DETAIL DETECTABLE WARNING SURFACE DETAILS FOR PEDESTRIAN RAMPS

ISSUE DATE: 03-01-2018

REVISIONS

Plate **T-059**



**NOTES**

1. WHERE DUMPSTERS ARE USED AN ENCLOSURE IS REQUIRED.
2. ENCLOSURE WALLS SHALL BE MASONRY, WEATHER RESISTANT WOOD, CHAIN LINK WITH SLATS, VINYL, ETC. THE FINAL DESIGN OF THE ENCLOSURE SHALL BE SUBJECT TO THE APPROVAL OF CITY PLANNING DEPARTMENT. ON A CASE-BY-CASE BASIS, THE PLANNING DEPARTMENT MAY ALLOW THE USE OF LANDSCAPE SCREENING IN LIEU OF AN ENCLOSURE.
3. A CITY OF HAGERSTOWN BUILDING PERMIT IS REQUIRED EITHER SEPARATE OR AS A PART OF THE OVERALL SITE CONSTRUCTION.
4. THE LOCATION OF THE DUMPSTER ENCLOSURE SHALL BE SITE SPECIFIC, BUT AT A NON-CONSPICUOUS LOCATION APPROVED AS A PART OF THE SITE PLAN AND/OR BUILDING PERMIT.
5. THE ENCLOSURE SLAB SHALL BE MD DEPT. OF TRANS. S.H.A. MIX NO. 3 CONCRETE, 3,500 P.S.I. COMPRESSIVE STRENGTH AT 28 DAYS WITH 5%-8% AIR ENTRAINMENT, 2" -5" SLUMP AND A LIGHT BROOM FINISH. DO NOT ADD WATER TO THE SURFACE FOR FINISHING. THE SLAB SHALL BE REINFORCED WITH #3 REBAR STEEL 6" O.C.E.W. OR 6X6-W4.0XW4.0 W.W.F. 2" UP FROM THE BOTTOM OF THE SLAB WITH 2" CLEAR TO ALL EDGES. THE SLAB THICKNESS SHALL BE 6". SLAB SLOPE SHALL BE SITE SPECIFIC.
- \* THE 3'-0" EXIT DOOR SHOWN IS OPTIONAL BUT THE GATES FOR THE DUMPSTER ACCESS ARE REQUIRED AND SHALL HAVE LATCHES.
7. THE REQUIREMENTS SHOWN HERE ARE MINIMAL. CONTACT YOUR WASTE HAULER FOR ALL OTHER REQUIREMENTS.

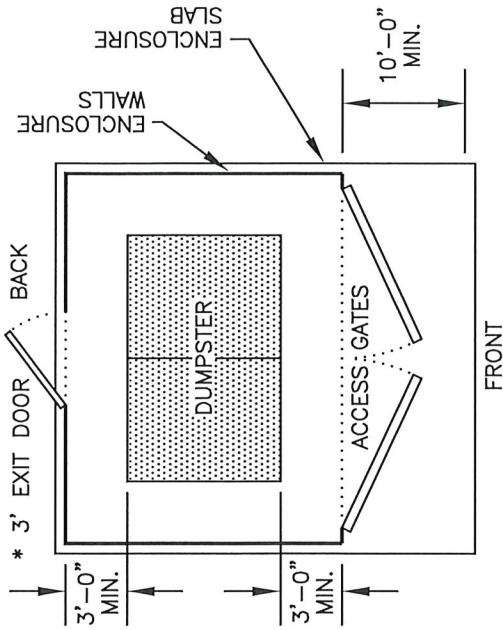

**PLAN VIEW**

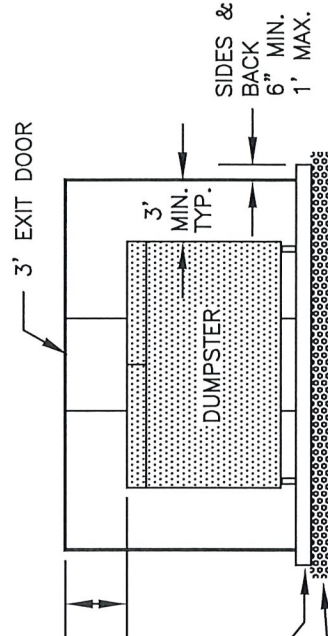

**ELEVATION VIEW**

(GATES NOT SHOWN)

6" THICK CONCRETE SLAB, SEE NOTE NO. 5  
 6" DEPTH COMPACTED GRADED AGGREGATE-BASE

6' MAXIMUM FENCE HEIGHT,  
 HIGHER FENCE HEIGHT,  
 APPROPRIATE ZONING APPROVAL



CITY OF HAGERSTOWN, MARYLAND - ENGINEERING AND INSPECTIONS DEPARTMENT

**MISCELLANEOUS STANDARD DETAIL  
 DUMPSTER ENCLOSURE REQUIREMENTS**

ISSUE DATE: 01-01-03

REVISIONS

01-01-07

Plate **M-023**

## TEMPORARY TRAFFIC CONTROL TYPICAL APPLICATION

**IMPORTANT:**  
THIS DRAWING SHALL BE USED IN COMBINATION WITH THE GENERAL NOTES MD 104.00-01 - MD 104.00-18 AND STANDARD DETAILS MD 104.01-01 - MD 104.01-81

**NOTES:**



SHOULDER CLOSED SIGNS ARE REQUIRED IN PLACE OF SHOULDER WORK SIGNS WHEN THE SHOULDER IS CLOSED BY POSITIVE PROTECTION (TEMPORARY CONCRETE BARRIER OR SIMILAR DEVICE). REFER TO STANDARD NO. MD 104.06-18.

WHEN WORK INVOLVES A PAVEMENT EDGE DROP-OFF, REFER TO STANDARD NOS. MD 104.06-15 TO MD 104.06-19.

THERE SHALL BE A MINIMUM OF SEVEN CHANNELIZING DEVICES IN THE SHOULDER TAPER.

THE ENGINEER SHOULD CONSIDER ADDITIONAL, ADJACENT LANE CLOSURES WHEN THE POSSIBILITY OF UNPLANNED TRAVELWAY ENCROACHMENTS EXISTS.

**KEY:**

- ■ CHANNELIZING DEVICES
-  SIGN SUPPORT  
 FACE OF SIGN
- ↑ DIRECTION OF TRAFFIC
-  WORK SITE

  
 (OPTIONAL FOR 15 MIN-12 HRS. OR DAYTIME APPLICATIONS)





(OPTIONAL FOR 15 MIN-12 HRS. OR DAYTIME APPLICATIONS)

WORK WITHIN 15 FT. OF EDGE LINE

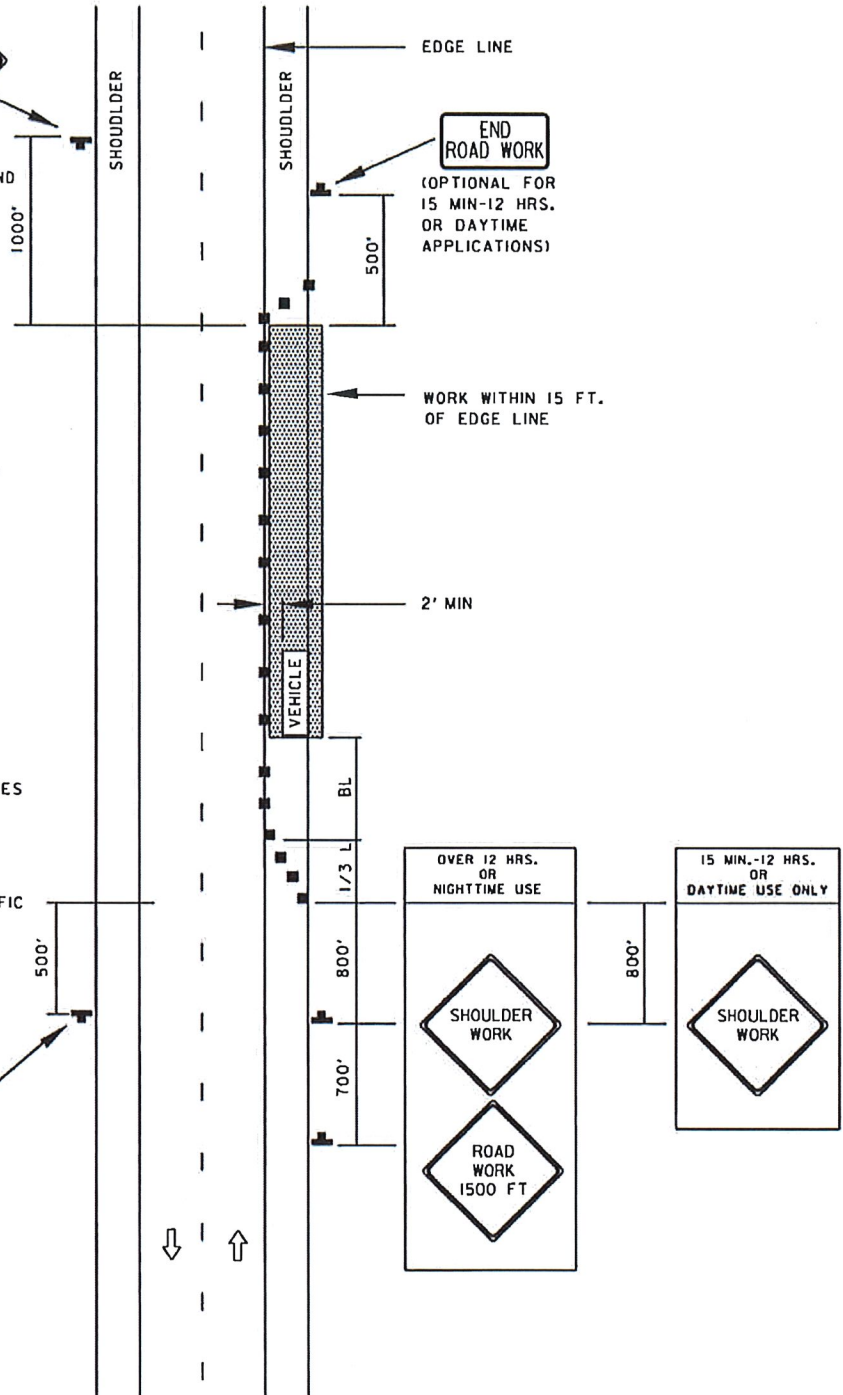
2' MIN

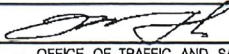

SPECIFICATION <b>104</b>	CATEGORY CODE ITEMS			
APPROVED	 DIRECTOR - OFFICE OF TRAFFIC AND SAFETY			
	APPROVAL • SHA REVISIONS	APPROVAL • FEDERAL HIGHWAY ADMINISTRATION		
	APPROVAL	8-20-03	APPROVAL	9-23-03
	REVISED	8-11-10	REVISED	10-5-10
	REVISED		REVISED	
	REVISED		REVISED	

**Maryland Department of Transportation**  
**STATE HIGHWAY ADMINISTRATION**  
 STANDARDS FOR HIGHWAYS AND INCIDENTAL STRUCTURES

**SHOULDER WORK/2-LANE, 2-WAY**  
**EQL/LESS THAN 40 MPH**

**STANDARD NO. MD 104.02-02**

## TEMPORARY TRAFFIC CONTROL TYPICAL APPLICATION

**NOTE:**  
 FLAGGER SHALL NEVER BE STATIONED MORE THAN 1000' AWAY FROM THE ADVANCE FLAGGER SIGN.  
 THE ENGINEER SHOULD CONSIDER ADDITIONAL, ADJACENT LANE CLOSURES WHEN THE POSSIBILITY OF UNPLANNED TRAVELWAY ENCROACHMENTS EXISTS.

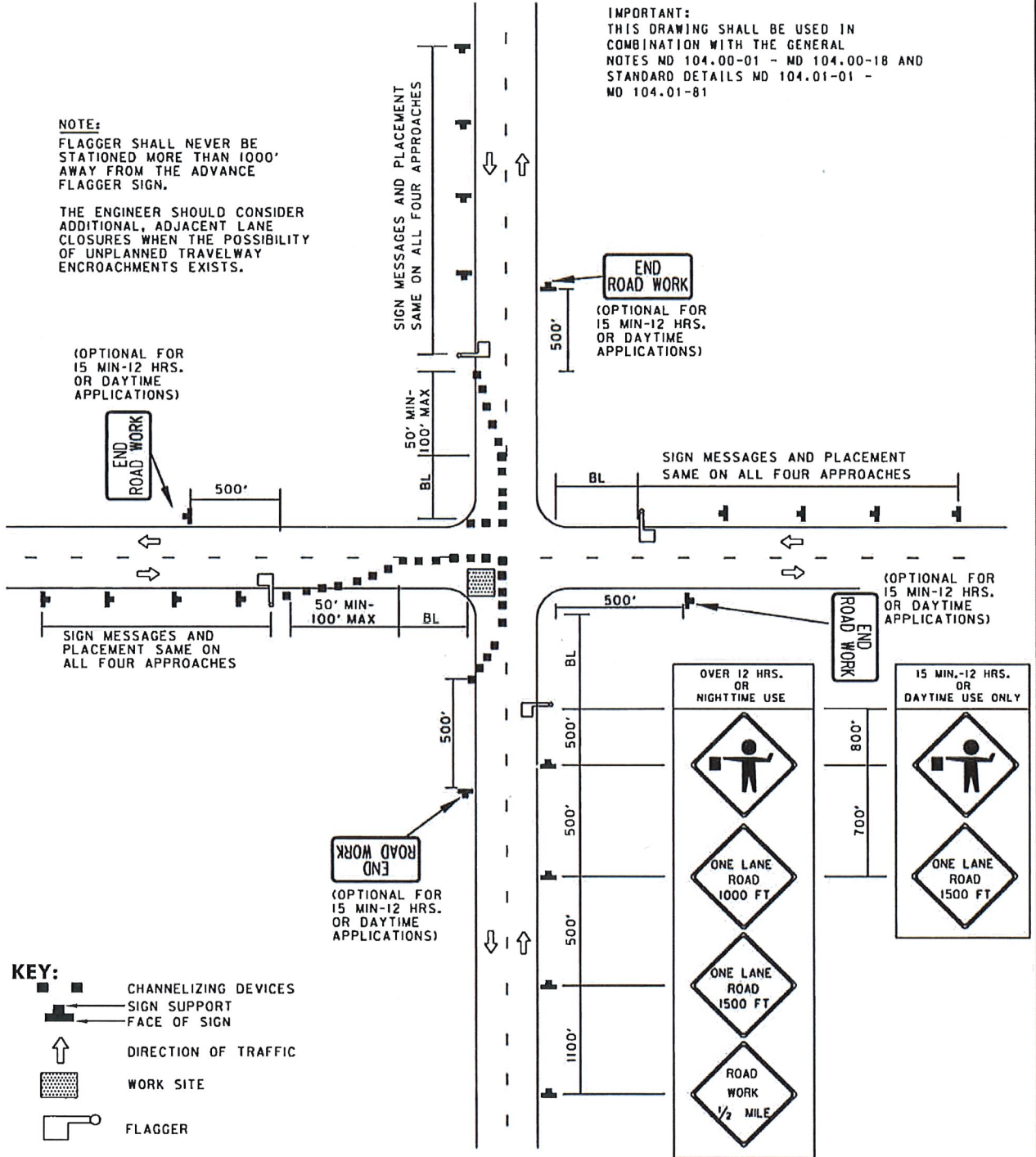

SPECIFICATION <b>104</b>	CATEGORY CODE ITEMS	
APPROVED	<i>[Signature]</i> DIRECTOR - OFFICE OF TRAFFIC AND SAFETY	
<b>SHA</b> State Highway Administration	APPROVAL • SHA REVISIONS	APPROVAL • FEDERAL HIGHWAY ADMINISTRATION
	APPROVAL 8-20-03	APPROVAL 9-23-03
	REVISED 8-11-10	REVISED 7-29-10
	REVISED	REVISED
	REVISED	REVISED

**Maryland Department of Transportation**  
**STATE HIGHWAY ADMINISTRATION**  
 STANDARDS FOR HIGHWAYS AND INCIDENTAL STRUCTURES  
**INTERSECTION FLAGGING OPERATION**  
**2-LANE, 2-WAY EQUAL OR LESS THAN 40 MPH**

**STANDARD NO. MD 104.02-14**

## TEMPORARY TRAFFIC CONTROL TYPICAL APPLICATION

**IMPORTANT:**  
THIS DRAWING SHALL BE USED IN COMBINATION WITH THE GENERAL NOTES MD 104.00-01 - MD 104.00-18 AND STANDARD DETAILS MD 104.01-01 - MD 104.01-81

**NOTE:**  
FLAGGER SHALL NEVER BE STATIONED MORE THAN 1000' AWAY FROM THE ADVANCE FLAGGER SIGN.

THE ENGINEER SHOULD CONSIDER ADDITIONAL, ADJACENT LANE CLOSURES WHEN THE POSSIBILITY OF UNPLANNED TRAVELWAY ENCROACHMENTS EXISTS.

**KEY:**

- ■ CHANNELIZING DEVICES
- SIGN SUPPORT
- FACE OF SIGN
- ↑ DIRECTION OF TRAFFIC
- ▨ WORK SITE
- ⌋ FLAGGER

**END ROAD WORK**  
(OPTIONAL FOR 15 MIN-12 HRS. OR DAYTIME APPLICATIONS)

**END ROAD WORK**  
(OPTIONAL FOR 15 MIN-12 HRS. OR DAYTIME APPLICATIONS)

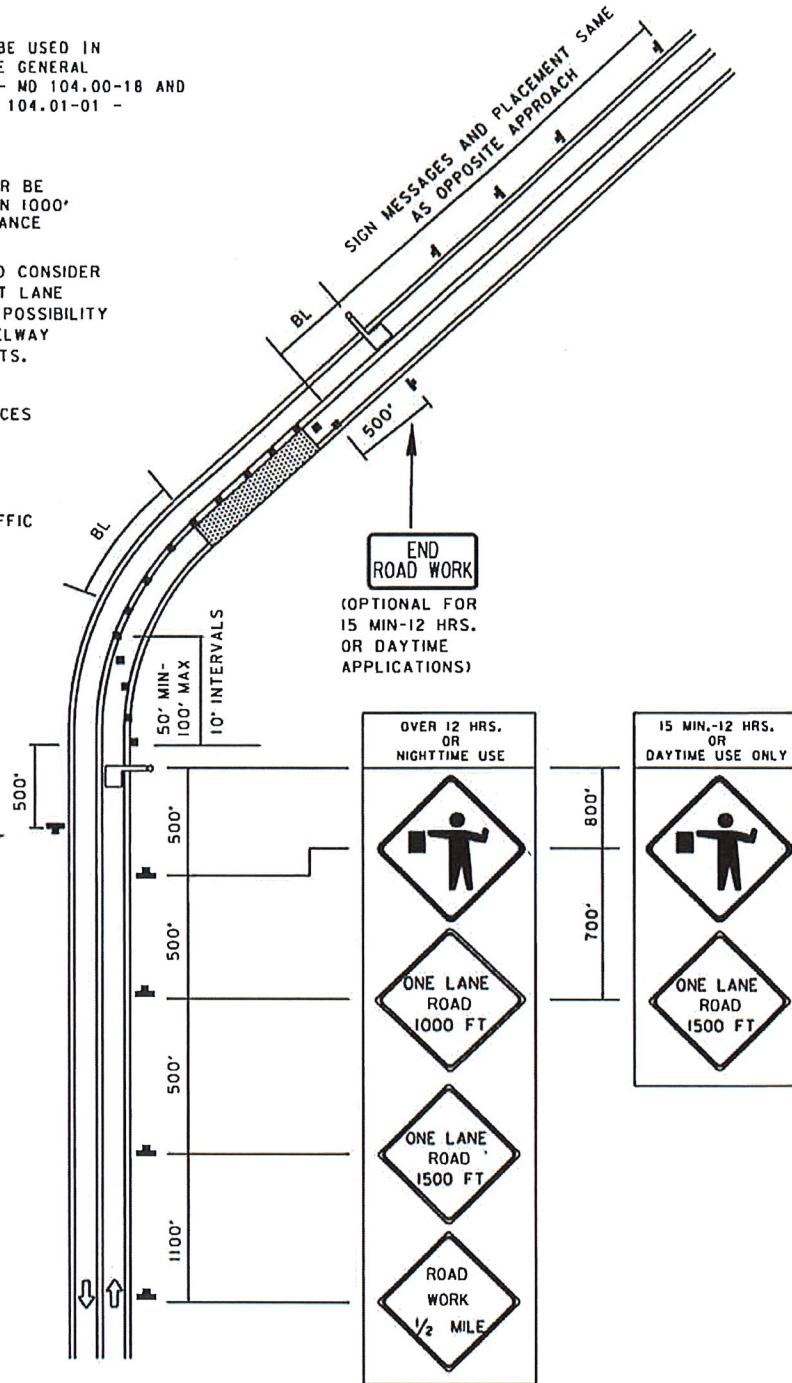

SPECIFICATION <b>104</b>	CATEGORY CODE ITEMS
APPROVED	 DIRECTOR - OFFICE OF TRAFFIC AND SAFETY
 State Highway Administration	APPROVAL - SHA REVISIONS
	APPROVAL - FEDERAL HIGHWAY ADMINISTRATION
	APPROVAL 8-20-03
	APPROVAL 9-23-03
	APPROVAL 8-11-10
REVISD	REVISD 7-29-10
REVISD	REVISD
REVISD	REVISD

**Maryland Department of Transportation**  
**STATE HIGHWAY ADMINISTRATION**  
STANDARDS FOR HIGHWAYS AND INCIDENTAL STRUCTURES  
**FLAGGING OPERATION/2-LANE, 2-WAY**  
**EQL/LESS THAN 40 MPH**

**STANDARD NO. MD 104.02-10**

ATTACHMENT 6













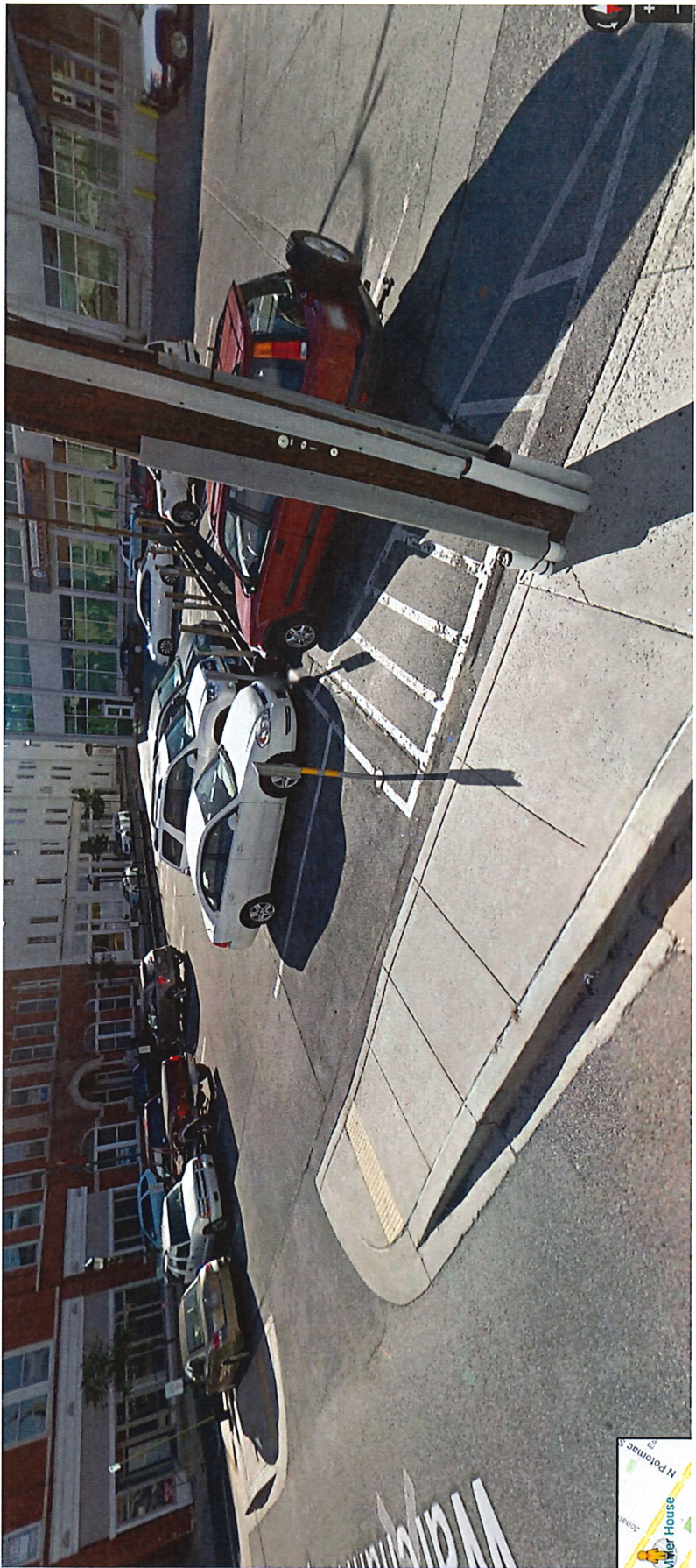



ATTACHMENT 7

# WASHINGTON COUNTY, MD



## GENERAL CONDITIONS

FOR

## CONSTRUCTION

October 2008





# GENERAL CONDITIONS (GC) TABLE OF CONTENTS

<i>Section</i>	<i>Item</i>	<i>Page</i>
<b>GC-SECTION 1</b>		
<b>DEFINITIONS AND TERMS</b>		
1.01	General	GC-1
1.02	Organizational Definitions	GC-1
1.03	Definitions	GC-2
1.04	Metric System	GC-11
1.05	Language	GC-11
<b>GC-SECTION 2</b>		
<b>BIDDING REQUIREMENTS AND CONDITIONS</b>		
2.01	Bid Irrevocable	GC-11
2.02	Contents of Bid Forms	GC-12
2.03	Interpretation of Quantities in Bid Schedule	GC-12
2.04	Site Investigation	GC-12
2.05	Taxes-Responsibility for Payment, Exemptions, Form to be Filed, Etc.	GC-13
2.06	Preparation of Bid	GC-14
2.07	Bid Security	GC-15
2.08	Delivery of Bids	GC-15
2.09	Communications and Interpretations – Prior to Bid Opening	GC-15
2.10	Addenda to Invitations for Bids	GC-16
2.11	Pre-Opening Modification or Withdrawal of Bids	GC-16
2.12	Late Bids, Late Withdrawals, and Late Modification	GC-16
2.13	Opening and Recording of Bids	GC-16
2.14	Mistakes in Bids	GC-17
2.15	Irregularities	GC-18
2.16	Cancellation of Invitations for Bids	GC-19
2.17	Rejection of Individual Bids or Proposals	GC-19
2.18	Rejection of all Bids	GC-21
2.19	Bid Evaluation and Award	GC-21
2.20	Tie Bids	GC-22
2.21	Multiple or Alternate Bids	GC-23
2.22	Bid Protests	GC-23
2.23	Political Contributions	GC-23

<i>Section</i>	<i>Item</i>	<i>Page</i>
----------------	-------------	-------------

**GC-SECTION 3  
AWARD AND EXECUTION OF CONTRACT**

3.01	Award of Contract	GC-23
3.02	Return of Bid Security	GC-23
3.03	Performance Bond and Payment Bond Requirements	GC-24
3.04	Execution of Contract	GC-24
3.05	Failure to Execute Contract	GC-25
3.06	W-9 Vendor Information	GC-25

**GC-SECTION 4  
SCOPE OF WORK**

4.01	Intent of Contract	GC-26
4.02	General Conditions Controlling	GC-27
4.03	Entire Contract	GC-27
4.04	Variations in Estimated Quantities	GC-27
4.05	Differing Site Conditions	GC-28
4.06	Changes	GC-28
4.07	Payment Provisions – Changes, Equitable Adjustments, Delays	GC-31
4.08	Unauthorized Work	GC-33
4.09	Final Clean Up	GC-33
4.10	Warranty of Construction	GC-34
4.11	Value Engineering Change Proposals	GC-35
4.12	Contingent Items	GC-37

**GC-SECTION 5  
CONTROL OF THE WORK**

5.01	Authority of the Engineer	GC-38
5.02	Conformity with Contract Requirements	GC-38
5.03	Discrepancies in the Contract Documents	GC-38
5.04	Cooperation by the Contractor	GC-39
5.05	Cooperation with Utilities	GC-39
5.06	Cooperation between Contractors	GC-40
5.07	Authority and Duties of Inspectors	GC-40
5.08	Inspection of Work	GC-41
5.09	Removal of Defective Work	GC-42
5.10	Load Restrictions	GC-42
5.11	Maintenance of Work During Construction	GC-42
5.12	Failure to Maintain Entire Project	GC-43

<i>Section</i>	<i>Item</i>	<i>Page</i>
5.13	Claims	GC-43
5.14	Shop Drawings	GC-46

## **GC-SECTION 6 CONTROL OF MATERIAL**

6.01	General	GC-49
6.02	Approval of Material Sources	GC-49
6.03	Approval of Plants and Shops	GC-51
6.04	Samples, Tests, Cited Specifications	GC-51
6.05	Certification of Compliance	GC-52
6.06	Project Control Testing	GC-52
6.07	Storage and Handling of Materials	GC-53
6.08	Unacceptable Materials	GC-53
6.09	Material Furnished by the County	GC-54

## **GC-SECTION 7 LEGAL RELATIONS AND RESPONSIBILITY TO THE PUBLIC**

7.01	Compliance with Laws	GC-54
7.02	Permits and Licenses	GC-55
7.03	Restoration of Surfaces Opened by Permit	GC-56
7.04	Patented Devices, Materials and Health Standards	GC-56
7.05	Federal Participation	GC-56
7.06	Construction Safety and Health Standards	GC-57
7.07	Public Convenience and Safety	GC-57
7.08	Maintenance of Traffic	GC-58
7.09	Maintenance of Traffic for Private and Commercial Properties	GC-61
7.10	Access to Railroad Rights-of-Way	GC-62
7.11	Preservation and Restoration of Property	GC-63
7.12	Land, Air and Water Pollution	GC-64
7.13	Indemnification and Insurance	GC-65
7.14	Use and Possession Prior to Completion	GC-68
7.15	Contractor's Responsibility for Work	GC-69
7.16	Contractor's Responsibility for Utility Property and Services	GC-70
7.17	Personal Liability of Public Officials	GC-70
7.18	Notices and Waiver of Legal Rights	GC-70
7.19	Choice of Law, Forum	GC-71
7.20	Audit and Retention of Records	GC-72
7.21	Use of Explosives	GC-72

*Section* *Item* *Page*

**GC-SECTION 8  
PROSECUTION AND PROGRESS**

8.01	Subcontracting	GC-73
8.02	Notice to Proceed	GC-75
8.03	Prosecution of the Work – Commencement – Time	GC-75
8.04	Progress Schedule	GC-76
8.05	Limitations of Operation	GC-77
8.06	Character of Workmen, Methods and Equipment	GC-77
8.07	Illegal Immigrants	GC-78
8.08	Suspension of Work	GC-79
8.09	Termination for Default – Damages for Delay – Time Extensions	GC-79
8.10	Liquidated Damages	GC-81
8.11	Termination for the Convenience of the County	GC-81
8.12	Successful Termination of Contractor’s Responsibility	GC-86

**GC-SECTION 9  
PAYMENT**

9.01	Scope of Payment	GC-86
9.02	Force Account Work	GC-89
9.03	Progress Payments	GC-92
9.04	Substantial Completion and Final Payment	GC-94
9.05	Measurements of Quantities	GC-98

# WASHINGTON COUNTY, MD GENERAL CONDITIONS FOR CONSTRUCTION CONTRACTS

## GENERAL CONDITIONS

### GC-SECTION 1 DEFINITIONS AND TERMS

These General Conditions include certain basic conditions and standard specifications common to all construction projects.

#### **GC-1.01 GENERAL**

Wherever in these General Conditions or in other Contract Documents the following terms or abbreviations are used, the meaning shall be as follows:

#### **GC-1.02 ORGANIZATIONAL DEFINITIONS**

- (a) **County** – The County of Washington County, Maryland, a body corporate and politic.
- (b) **Deputy Director** – The Washington County Deputy Director of Public Works (Capital Projects) or the Deputy Director of Environmental Management (Engineering Services) whichever has responsibility for the Contract.
- (c) **Director** – The Washington County Director of Public Works or Director of Environmental Management, whichever has responsibility for the Contract.
- (d) **Division** – The word Division shall mean the Washington County Division of Public Works or the Division of Environmental Management, whichever has responsibility for the Contract.
- (e) **Engineer** – the word Engineer will refer to the County's assigned Project Representative within the Washington County Division of Public Works or the Division of Environmental Management or his/her duly authorized representative.
- (f) **Inspector** – The authorized field representative of the Engineer assigned to make detailed inspection for compliance with the Contract Documents of any or all

portions of the work, or materials thereof. Unless otherwise specifically stated in the Contract documents, the Inspector is not authorized to make code inspections.

- (g) **Purchasing Agent** – The Director of the Washington County Purchasing Department or his/her designee.

### **GC-1.03 DEFINITIONS**

1. **Advertisement** – The public announcement, as required by law, inviting Bids for work to be performed or materials to be furnished.
2. **Agencies/Agency** – Whenever in the Contract Documents reference is made to any federal, state, or county agency or officer, such reference shall be deemed made to any agency or officer succeeding in accordance with law to the powers, duties, jurisdictions and authority of the agency or officer mentioned as it pertains to the Contract.
3. **As-Built Plans** – A set of contract drawings marked in red that clearly reflect the detailed differences between actual construction and those of the original Contract Documents as they existed at the time of award.
4. **Award** – The acceptance by the County of the Bid of the lowest responsive and responsible Bidder for the Work subject to the execution and approval of a satisfactory Contract therefore and Bond when required to secure the performance thereof, and to such other conditions as may be specified or otherwise required by law.
5. **Base Course** – The layer or layers of specified selected material of designed thickness placed on a subbase or a subgrade to support a surface course.
6. **Bid** – A statement of price, terms of sale, and description of the supplies, services, construction or construction-related services offered by a Bidder to the County in response to an Invitation for Bids. Also referred to as Proposal.
7. **Bid Security** – The security in the form required by the County in the Bid and executed by the Bidder and its Surety. The Bid Security (when required) shall be in the amount designated by the County as a guarantee on the part of the Bidder to enter into a Contract with the County, if the work of constructing the improvement is awarded to the Bidder, and to post acceptable Payment and Performance Bonds.
8. **Bid Item** – An item of work specifically described in the Invitation for Bids and for which a price, either unit or lump sum, is provided. It includes the performance of all work and the furnishing of all labor, equipment and materials. A Bid Item is synonymous to a contract item or a pay item.
9. **Bid Form** – The approved form on which the County requires Bids to be set forth and submitted.

10. **Bidder** – A Person formally submitting a Bid for the Work contemplated, acting directly or through a duly authorized representative.
11. **Bridge** – A bridge shall be any structure so defined under the FHWA Guidelines. It shall also include any bridge or highway grade separation structure and shall embrace the substructure and superstructure and the approaches thereto, and such entrance plazas, interchanges, overpasses, underpasses, connection highways and other structures which the County may deem necessary in connection therewith, together with all property rights, easements, franchises and interests acquired by the County for the construction and operation of such bridge.

For the convenience of and definition by the County, a bridge will also be known as a structure more than 20 feet in span. The County's definition of length shall be the out-to-out dimension of the floor or from back wall to back wall of abutments. Bridges less than 20 feet in span shall be considered culverts or small structures. Culverts may be designated as arches, box culverts, or pipes. For arches, the length shall be clear span. For box culverts and batteries of pipes, the length shall be out to out of outer walls and out to out of shells of outside pipes. For lengths, all dimensions shall be parallel to the centerline of the roadway. The dimensions of handrails will not be taken into account in measuring bridge lengths.

12. **Calendar Day** – Every day shown on the calendar, Saturdays, Sundays, and Holidays included.
13. **Change Order** – A written order issued by the Purchasing Agent and approved by the Deputy Director and the Director which changes the Contract Documents within the general scope of the Contract and establishes the basis of payment or credit and/or time adjustments for the work affected by the changes.
14. **Claim** – A written demand or assertion by one of the parties seeking, as a legal right, an equitable adjustment including the payment of money, adjustment or interpretation of the Contract Documents, or other relief, arising under or relating to this Contract.
15. **Contingent Item** – Any item listed on the Plans or called for in the Special Provisions and included in the Bid merely for the purpose of obtaining a Contract price in case it may be needed.
16. **Contract** – The written agreement executed between the County and the successful Bidder, covering the performance of the work and furnishing of labor, equipment and materials, by which the Contractor is bound to perform the work and furnish the labor, equipment and materials, and by which the County is obligated to compensate him/her, therefore, at the mutually established and accepted rate or price.
17. **Contract Documents** – The Contract Documents consist of the Invitation for Bids, the Bid, the Contract, the Payment and Performance Bonds, General Conditions,

Specifications, all Special Conditions, all Drawings, all Addenda, Award Letter, Notice to Proceed, also any written Change orders and Supplemental Agreements that are issued to complete the construction of the work in an acceptable manner, including authorized extensions thereof.

18. **Contract Time or Completion Date** – the number of working or calendar days shown in the Bid indicating the time allowed for the completion of the work contemplated in the contract. In case a calendar date of completion is shown in the Bid, in lieu of the number of working or calendar days, such work shall be completed by that date.
19. **Contractor** – A person undertaking the execution of the Work under the terms of the Contract Documents acting directly or through its agents or employees.
20. **County Road** – The term “County Road” means any public road in Washington County, excluding State Highways, title to which, or the easement for the use of which, is vested in a public body or governmental agency by grant, condemnation, dedications, or operation of law.
21. **Culvert** – An arched drain for the passage of water under a roadway, driveway, entranceway or other passageway.
22. **Day** - Every day shown on the calendar, Saturdays, Sundays and Holidays included.
23. **Domestic Manufacture** – When referring to metallic items such as structural steel, pipe, reinforcement, bridge rails, etc., the term “Domestic Manufacture” is intended to mean those metals whose final alloying has taken place within the confines of the Continental United States.
24. **Drainage Ditch** – In general, any open water course other than gutters, constructed beyond the limits of cut or fill slopes for excavation or embankment as indicated by the typical section shown on the plans.
25. **Engineers Supplemental Information (ESI)** – A written notice or response containing information provided by the Engineer as a clarification or supplement to the Contract Documents.
26. **Equipment** – All machinery, tools, and apparatus necessary for the proper construction and acceptable completion of the Work, together with the necessary supplies for operation, transportation, storage, upkeep, and maintenance.
27. **Estimate** – The measurement of quantities by the Engineer or the Inspector of various pay items and/or lump sum items of work based on the Contract definitions for method of measurement and basis of payment for each item.
28. **Extra Work** – Work that was not provided for in the original Contract. Extra Work is synonymous with additional work.



**29. Fixed-Price Contingent Items** - Bid Items for which unit prices are established by the County to compensate the Contractor for the cost of work and materials in the event that the item may be needed. In the event that a quantity is shown on the Bid sheet for a Fixed-Price Contingent Item, such quantity is intended solely for the purpose of generating a total price extension which will be added to the price totals of items Bid. No representation is made or intended to be made that the quantity shown, or any quantity, will be used.

**30. Holidays**

The County observes a five-day work week and the following holidays:

January 1	-	New Year's Day
January (3 <sup>rd</sup> Monday)	-	Martin Luther King Day
February (3 <sup>rd</sup> Monday)	-	Presidents Day
March/April	-	Good Friday
May (last Monday)	-	Memorial Day
July 4	-	Independence Day
September (1 <sup>st</sup> Monday)	-	Labor Day
November 11	-	Veterans Day
November (4 <sup>th</sup> Thursday)	-	Thanksgiving Day
November (4 <sup>th</sup> Friday)	-	Day after Thanksgiving Day
December 24	-	Christmas Eve
December 25	-	Christmas Day
December 31	-	New Year's Eve

(a) If any holiday occurs on Sunday, the following Monday shall be considered a holiday. If the holiday occurs on Saturday, the Friday immediately preceding shall be considered a holiday. The County reserves the right to adjust the holiday schedule.

(b) The Contractor will not be permitted to work on the above-mentioned holidays, or Saturdays unless requested 48 hours in advance by written notice. If the Engineer approves the request, he/she will authorize this in writing and the Contractor will not be charged for the inspector's time. In the event that the Contractor fails to work its forces as indicated in its written request, he/she shall be charged a minimum of ½ day for inspection time at the overtime rate.

(c) The normal number of working hours per day on this contract will be limited to nine, unless otherwise specified or authorized by the Engineer in writing.

(d) In case of an emergency, which may require that work be done on Saturday's, Sundays, holidays, or longer than nine hours per day, the Contractor shall request permission of the Engineer to do so. If in the opinion of the Engineer the emergency is bona fide, he/she will grant permission to the Contractor to work such hours as may be necessary. Also, if in the opinion of the Engineer a bona fide emergency exists, he/she

may direct the Contractor to work such hours as may be necessary whether the Contractor requests permission to do so or not.

31. **Invitation For Bids** – The advertisement soliciting Bids for all work and/or materials on which Bids are required. Such advertisement or Invitation for Bids will indicate with reasonable accuracy the location and magnitude of the work to be done and/or the character and quantity of the material to be furnished and the time and place of the opening of Bids.
32. **Laboratory** – The testing laboratory of Washington County or any other testing laboratory that may be designated by the Engineer.
33. **Materials** – Any substances specified for use in the construction of the Project and its appurtenances.
34. **Median** – The portion of a divided highway separating the traveled ways for traffic in opposite directions.
35. **Minority Business Enterprise (MBE)** – Unless otherwise specifically addressed in the Special Provisions or other Contract Documents, any legal entity, other than a joint venture, organized to engage in commercial transactions which is at least 51 percent owned and controlled by one or more minority persons, or a nonprofit entity organized to promote interest of the physically or mentally disabled.
36. **Minority or Minority Person** – Unless otherwise specifically addressed in the Special Conditions or other Contract documents, a member of one of the following socially and economically disadvantage groups:
  - (a) African American – An individual having origins in any of the Black racial groups of Africa;
  - (b) American Indian/Native American – An individual having origins in any of the original peoples of North America and who is a documented member of a North American tribe, band, or otherwise organized group of native people who are indigenous to the continental United States or who otherwise have a special relationship with the United States or a state through treaty, agreement, or some other form of recognition. This includes an individual who claims to be an American Indian/Native American and who is regarded as such by the American Indian/Native American community of which he/she claims to be a part, but does not include an individual of Eskimo or Aleutian origin;
  - (c) Asian – An individual having origins in the far East, Southeast Asia, or the Indian Subcontinent and who is regarded as such by the community of which the person claims to be a part;

- (d) **Hispanic** – An individual of Mexican, Puerto Rican, Cuban, Central or South American, Portuguese or other Spanish culture or origin regardless of race, and who is regarded as such by the community of which the person claims to be a part;
- (e) **Women** – This category shall include all women, regardless of race or ethnicity, although a woman who is also a member of an ethnic or racial minority group may elect that category in lieu of the gender category; or
- (f) **Physically or Mentally Disabled** – An individual who has an impairment that substantially limits one or more major life activity, who is regarded generally by the community as having such a disability, and who disability has substantially limited his or her ability to engage in competitive business.
37. **Notice To Proceed** – A written Notice to the Contractor of the date on or before which it shall begin the prosecution of the work to be done under the Contract.
38. **Payment Bond** – The security in the form approved by the County and executed by the Contractor and his/her Surety, and paid for by the Contractor, as a guarantee that he/she will pay, in full, all bills and accounts for materials and labor used in the construction of the work, as provided by law.
39. **Performance Bond** – The security in the form approved by the County and executed by the Contractor and his/her surety and paid for by the Contractor, guaranteeing complete performance of the Contract including indemnification, warranties and repair of latent defects.
40. **Person** – any individual, partnership, firm, corporation, association, or joint venture authorized to conduct business in Maryland.
41. **Plans or Drawings** – The official plans and drawings issued by the County as part of the Contract Documents, including those incorporated in the Contract Documents by reference. These include the official approved drawings, profiles, typical cross sections, working drawings and supplemental drawings or exact reproduction thereof which show the location, character, dimensions and details of the work to be done. Plans are synonymous with contract drawings.
42. **Profile Grade** – The trace of a vertical plane intersecting the top surface of the proposed wearing surface usually along the longitudinal centerline of the roadbed. Profile grade means either elevation or gradient of such trace according to the context.
43. **Project** – The construction of, reconstruction of, relocation of, or the major maintenance of any County facility, or portion thereof.
44. **Project Representative** – The executive representative of the Contractor authorized to receive and execute instructions from the Engineer and who shall manage and direct the Project.

45. **Questionnaire** – the approved form or forms upon which the Bidder shall furnish the information as to his/her ability to perform the work, his/her experience in similar work, the equipment to be used, and its financial condition as related to his/her ability to finance the work.
46. **Record Counterpart Document** – Contract Documents that have been compiled by the County and formally executed by the parties to the Contract and shall be the governing document for the project.
47. **Request For Information (RFI)** – A written request for information or clarification by one of the Contract parties often pertaining to the Contract documents.
48. **Request for Payment** – The Contractor’s formal submittal for payment for work completed, usually on a monthly basis and at the conclusion of the Contract, to the Engineer using the format specified by the Engineer.
49. **Right-of-Way** – Includes roadway surfaces, roadway subgrades, shoulders, median dividers, drainage facilities and structures, roadway cuts, roadway fills, guardrails, bridges, highway grade elimination structures, tunnels, overpasses, underpasses and other structures forming an integral part of a road or highway, pipeline, or utility appurtenances.
50. **Roadside** – A general term denoting the area adjoining the outer edge of the roadbed within the right-of-way. Extensive areas between the roadways of a divided highway may also be considered roadside.
51. **Roadside Development** – Those items necessary to the complete Road or Highway which provide for the preservation of landscape materials and features; the rehabilitation and protection against erosion of all areas disturbed by construction through seeding, sodding, mulching and the placing of other ground covers; such suitable planting and other improvements as may increase the effectiveness and enhance the appearance of the Road or Highway.
52. **Road or Street** – Both the word “Road” and the word “Street” include rights of way, roadway surfaces, roadway subgrades, shoulders, median dividers, drainage facilities, roadway cuts, roadway fills, traffic barriers, bridges, highway grade elimination structures, tunnels, overpasses, underpasses and other structures forming an integral part of a road or highway.
53. **Seal Coat** – An application to pavement surfaces of bituminous material followed by an application of cover coat aggregate. Also referred to as chip seal.
54. **Shoulder** – The portion of the roadbed contiguous with the traveled way for accommodation of stopped vehicles, or emergency use and for lateral support of base and surface courses.

55. **Shop Drawings** – All drawings, diagrams, illustrations, schedules and other data which are specifically prepared by or for the Contractor to illustrate some portion of the work and all illustrations, brochures, standard schedules, performance charts, instructions, diagrams and other information prepared by a supplier and submitted by the Contractor to illustrate material or equipment for some portion of the Work.
56. **Sidewalk, Pathway, or Walkway** – A surface primarily constructed for the use of pedestrians, usually at the side of a roadway.
57. **Slopes** – The inclined graded area beyond the shoulder and extending from the shoulders to the natural undisturbed surface of the ground.
58. **Special Conditions** – Special directions, provisions, or requirements applicable to the Project.
59. **Standard Details** – Detailed drawings with dimensions of components which have been established for general application and repetitive use.
60. **Standard Specifications** – A book of Specifications intended for general application and repetitive use.
61. **State** – The State of Maryland acting through its authorized agency or representative.
62. **State Highway System** – That system of roads which is from time to time owned by the State and which the State by resolution from time to time designates as State roads to be maintained and operated by the State Highway Administration.
63. **State Road** – Any public road included in the State Highway System.
64. **Structures** – Bridges, culverts, catch basins, drop inlets, retaining walls, cribbing, manholes, vaults, endwalls, buildings, sewers, service pipes, underdrains, foundation drains and other features which may be encountered in the work and not otherwise classed herein.
65. **Subbase** – The layer or layers of specified selected material of designed thickness placed on subgrade to support a base course.
66. **Subcontractor** – Any Person undertaking the construction of a part of the work by virtue of an agreement with the Contractor, who, prior to such undertaking, received the consent of the Surety and the approval of the County.
67. **Subgrade** – The material in any excavation (cuts) and embankments (fills) immediately below any subbase, base, pavement, shoulder, or other improved course.

68. **Substructure** – All of that part of the structure below bottoms of bearings of simple and continuous spans, skewbacks of arches, and tops of footings of rigid frames, together with the back walls and wing walls.
69. **Superstructure** – All of that part of the structure above bottoms of bearings of simple and continuous spans, skewbacks of arches and tops of footings of rigid frames, except as noted for Substructure.
70. **Supplemental Agreement** – A written agreement covering added or changed work which is beyond the scope of the Contract and the Changes Section of these General Conditions. A Supplemental Agreement becomes a part of the Contract when approved and properly executed by all parties to the Contract.
71. **Supplemental Specifications** – Additions and revisions to the Standard Specifications. Generally include new or improved procedures, construction items or materials developed subsequent to the publication of Standard Specifications.
72. **Surety** – The approved corporate body bound with and for the Contractor, for the full and complete performance of the Contract, and for the payment of all debts pertaining to the work. When applying to the Bid Bond, it refers to the corporate body that engages to be responsible in the execution by the Bidder of a satisfactory Contract and the posting of Payment and Performance Bonds.
73. **Surface Treatment** – The application of one or more seal coats, each over a layer of specified aggregate, exclusive of shoulders and auxiliary lanes.
74. **Temporary Easement** – An area, adjacent to the right-of-way or easement, temporarily acquired for the use of the Contractor during the execution of the work. This area is only present when shown on the plans.
75. **Trench** – An excavation made for the purpose of installing or removing pipes, drains, catch basins, etc.
76. **Unbalanced Bid** – A bid based on prices significantly less than cost for some work and prices which are significantly overstated in relation to cost for other work, and if there is a reasonable doubt that the bid will result in the lowest overall cost to the County even though it may be the low evaluated bid, or if it is so unbalanced as to be tantamount to allowing an advance payment.
77. **Utilities** – Storm drain, sanitary sewers, water mains, gas, electric and communication equipment and all appurtenances thereto.
78. **Work** – The furnishing of all labor, materials, equipment and other incidentals necessary to the successful completion of the Project and the carrying out of all the duties and obligations imposed by the Contract Documents.

- 79. Written Notice** – Any letter, memorandum, hand-written document, telegram, or other written instrument, formal or informal, signed and dated by its author and transmitted by hand-delivery, facsimile, U.S. Postal Service or other special delivery courier. The Written Notice may be sent to the mailing address of the parties identified in the Record Counterpart Document or the authorized on-site representative of one of the Contracting parties. A bona fide email messages between known addresses identified by the Contracting parties may also constitute a written notice.

#### **GC-1.04 METRIC SYSTEM**

The County recognizes the attempts of gradual transition in the construction and other industries to the use of the International System of Units (SI). In keeping with this trend, these General Conditions frequently show approximate equivalencies between U.S. Customary Units and the International System of Units. Selection of units and symbols, conversion, rounding and other matters relating to the equivalencies have been carried out in accordance with The American Association of State Highway and Transportation Officials (AASHTO) R-I. Should the necessity for additional conversion arise, the same practice shall be followed.

It is the intent of these General Conditions that where values in both systems are shown in describing a single requirement, the first named will govern regardless of the system from which it is derived.

#### **GC-1.05 LANGUAGE**

In order to avoid cumbersome and confusing repetition of expressions in these General Conditions, it is provided that whenever anything is, or is to be, done, if, as, or, when, or where “contemplated, required, determined, directed, specified, authorized, ordered, given, designated, indicated, considered necessary, deemed necessary, permitted, reserved, suspended, established, approval, approved, disapproved, acceptable, unacceptable, suitable, accepted, satisfactory, sufficient, insufficient, rejected, or condemned,” it shall be understood as if the expression were followed by the words “by the Engineer” or “to the Engineer” unless the context clearly indicates otherwise.

### **GC-SECTION 2 BIDDING REQUIREMENTS AND CONDITIONS**

#### **GC-2.01 BID IRREVOCABLE**

Unless otherwise provided in the Invitation for Bids, Bid prices are irrevocable for ninety (90) days following Bid opening.

## **GC-2.02      CONTENTS OF BID FORMS**

(a) After the date is fixed for the bidding of the Work, the County will give notice of such bid to Bidders. The Invitation for Bids will contain a description of the proposed Work, the time and place where Sealed Bids will be received, together with information regarding access to information to the Contract Documents, the price of these documents, and the reservation of the right of the County to reject any or all Bids.

(b) All papers included in, bound thereto or attached to the Bid Form are necessary parts thereof and shall not be detached, separated, or altered. Where pay items are unit price items, the Bid Forms will further show an estimate of quantities expected to occur in such unit price items. All Contract Documents with the exception of subsurface data and borings will be considered a part of the Bid Form whether attached thereto or not. Any subsurface data and borings are provided for informational purposes only, and are not part of the Contract Documents.

(c) The Invitation for Bids shall describe location and types of work contemplated by the Contract. The invitation for bids will also set forth the place, date and time of opening Bids, the requirements of a bid Bond and the time to be allowed for completing the Contract. The County may charge a fee for each set of Invitation for Bids and Contract Documents. The amount of such charge will be set forth in the Invitation for Bids. The fee charged for Invitation for Bids and the Contract Documents is not returnable.

(d) Should one or more addenda be issued during the bidding period of this Contract, a certificate of receipt shall accompany such addenda. All certifications of receipts of addenda must be signed by the Bidder and accompany his/her Bid Form, otherwise his/her Bid shall not be accepted. If certificates of receipts are not provided by the County, the addenda must be acknowledged in the appropriate space provided for on the bid form.

## **GC-2.03      INTERPRETATION OF QUANTITIES IN BID SCHEDULE**

(a) Where designated as estimated quantities, the quantities appearing in the prepared Bid Schedule are approximate only and are prepared for the canvassing of Bids. Payment to the Contractor will be made only for the actual quantities of work performed or materials furnished in accordance with the Contract and as provided for in GC-4.04, Variations in Estimated Quantities. It is understood that the scheduled quantities of work to be done and materials to be furnished may each be increased, diminished or omitted without in any way invalidating prices Bid, except as hereinafter provided.

## **GC-2.04      SITE INVESTIGATION**

(a) The Bidder acknowledges that he/she has investigated and satisfied him/herself as to the conditions affecting the Work, including but not restricted to those bearing upon transportation, disposal, handling and storage of materials, availability of labor, water, electric



power, roads and uncertainties of weather, river stages, tides or similar physical conditions at the site, the conformation and conditions of the ground, the character of equipment and facilities needed preliminary to and during prosecution of the Work. The Bidder further acknowledges that he/she has satisfied him/herself as to the character, quality and quantity of surface and subsurface materials or obstacles to be encountered insofar as this information is reasonably ascertainable from an inspection of the site, including all exploratory work done by the County, as well as from information presented by the drawings and Specifications made a part of this Contract.

(b) Available subsurface data and the results of subsurface investigations shall be made available to the Contractor. Unless the Contract Documents expressly state otherwise, this data is not guaranteed, warranted, or represented as accurate by the County. Geological conditions should be independently investigated and/or verified by the Bidder prior to submission of his/her Bid. No adjustment in contract price will be allowed by the County for differing subsurface conditions, unless otherwise provided for in the Contract Documents.

(c) Where subsurface conditions are indicated in the Contract Documents, they have been so indicated from the best information available and for the information of all parties concerned. The County assumes no responsibility for the accuracy of such information and should any Bidder or Contractor rely solely on such information in the preparation of his/her Bid for the performance of the work, he/she does so at his/her own risk. Whether or not subsurface conditions are shown in the Contract Documents, the Bidder or Contractor is not relieved of the responsibility of making his/her own investigation to determine for themselves the conditions present and in what quantity. The presence or absence of a material, or the increase or decrease in quantities indicated, shall not entitle the Contractor to additional compensation above or beyond the stipulated contract sum.

**GC-2.05 TAXES-RESPONSIBILITY FOR PAYMENT, EXEMPTIONS, FORMS TO BE FILED, ETC.**

(a) The Contractor is responsible for and by submitting a Bid agrees to pay all retail sales, income, real estate, sales and use, transportation and special taxes applicable to and assessable against any materials, equipment, processes and operations incident to or involved in the Project. The Contractor is responsible for ascertaining and acquainting his/herself with such taxes and making all necessary arrangements to pay same.

(b) The Contractor shall complete a W-9 Vendor Information form (provided by the County) and return it to the Purchasing Agent.

(c) The County hereby reserves the right to withhold payment under this Contract until the Contractor and any subcontractor performing any duties under this Contract have furnished or caused to be furnished the Comptroller of the State of Maryland with all properly completed forms required by the said Comptroller and until all of said retail sales and/or use taxes due the State of Maryland by the Contractor have been paid and the Contractor exhibits a release or receipt from the Comptroller evidencing such payment.

(d) The Contractor is hereby advised of Section 1-106(b)(3) of the Code of Public Local Laws of Washington County, MD: “If a bidder has not paid all taxes owed to the County or a municipal corporation in the County, the County Commissioners may reject the bidder’s bid.”

## **GC-2.06 PREPARATION OF BID**

(a) The Bidder shall submit his/her single Bid set upon the Bid Form(s) furnished by the County. The Bidder shall specify a price in dollars and cents, for each pay item given, and shall show the products of the respective unit prices and quantities written in figures in the column provided for that purpose, together with the total amount of the Bid obtained by adding the amounts of the several items, Bidders must not change any item in the Bid for which a price has been stipulated by the County. Any such change will cause rejection of the Bid.

(b) The Bid Form(s) shall be filled out in ink or typed. All Bids shall be signed in ink. All erasures or alterations shall be initialed by the signer in ink. The Bid, if submitted by an individual, shall be signed by the individual; if submitted by a partnership, shall be signed by such member or members of the partnership as have authority to bind the partnership; if submitted by a corporation, the same shall be signed by an officer and attested by the corporate secretary or an assistant corporate secretary; if submitted by a joint venture, the same shall be signed by such member or members of the joint venture as have authority to bind the joint venture. If not signed by an officer, as aforesaid, there must be attached a copy of that portion of the Bylaws or a copy of a Board resolution, duly certified by the corporate secretary, showing the current authority of the person so signing on behalf of the corporation. In lieu thereof, the corporation may file such evidence with the County, duly certified by the corporate secretary, together with a list of the names of those officers having authority to execute documents on behalf of the corporation, which listing shall remain in full force and effect until such time as the County is advised in writing to the contrary. In any case where a Bid is signed by an Attorney in Fact, the same must be accompanied by a copy of the appointing document, duly certified.

(c) If the Invitation for Bids requires the Bidder to furnish samples or descriptive literature, it shall be submitted with the Bid, unless the Invitation for Bids provides otherwise.

(d) Bidders shall identify those portions of their Bids that they deem to be confidential, proprietary information or trade secrets and provide any justification of why such materials should not be disclosed by the County under the Maryland Public Information Act, Section 10-611 et seq. of the County Government Article of the Annotated Code of Maryland.

(e) The County will attempt to cooperate in making available to the Bidders for his/her use various documents in their original form or electronic data format.

(1) The County will not be responsible for providing the electronic data in any format or versions other than those used by the County nor will the County make available any equipment, hardware, or other devices to examine or reproduce the data.

(2) Washington County makes no warranty as to the accuracy of drawings, specifications, reports and other electronic data nor will the County accept any responsibility for errors and omissions which may arise as a result of the Bidder having relied upon them.

(3) The Bidder is in no way authorized to manipulate, alter, or reformat documents for use during bidding such as proposal forms, bonds, and other bid documents. At any point subsequent to receiving bids or award and execution of a Contract, should the County discover that the bidder has done so, the County reserves the right to reject the bid and/or terminate the Contract and pursue whatever action may be in the best interest of the County.

#### **GC-2.07 BID SECURITY**

(a) No Bid will be considered unless accompanied by a Bid Security of the character and in an amount not less than the specific dollar value indicated in the Bid Form, and made payable to the Washington County Treasurer.

(b) Acceptable forms of security for Bid Security shall be:

(1) A bond in a form satisfactory to the County underwritten by a surety company authorized to do business in this State and which is on the United State Department of Treasury Approved List; or

(2) A bank certified check, bank cashier's check, or bank treasurer's check.

(c) All costs of the Bid Security shall be paid by the Bidder.

#### **GC-2.08 DELIVERY OF BIDS**

Each Bid must be submitted in a sealed opaque envelope plainly marked to indicate its contents or in an envelope furnished by the County. The blank spaces on the County envelope should be filled in so as to clearly indicate its contents. When sent by mail, the sealed Bid must be addressed to the Washington County agency and exact address specified in the Invitation for Bids. All bids shall be filed prior to the time and at the place specified in the Invitation for Bids, as amended by any applicable addenda. Bids received after the time for opening of Bids will be returned to the Bidder unopened.

#### **GC-2.09 COMMUNICATIONS AND INTERPRETATIONS— PRIOR TO BID OPENING**

Any information regarding the requirements or the interpretation of any provision of the General Conditions, Specifications, Supplemental Specifications, or any part of the Contract Documents shall be requested, in writing, from the County agency listed in the Invitation for

Bids, and delivered no later than the number of date and time specified in the Invitation for Bids. Responses to questions or inquires having any material effect on the Bids shall be made by written addenda, or by written notice sent to all prospective Bidders. DO NOT MAKE VERBAL INQUIRIES. Any verbal interpretations or oral pre-Bid statements made by County employees or their representatives shall not be binding upon the County.

#### **GC-2.10 ADDENDA TO INVITATIONS FOR BIDS**

(a) **Form** – Each addendum to an Invitation for Bids shall be in written form and identified as such.

(b) **Acknowledgments** – Unless otherwise provided, the Bidder shall acknowledge receipt of all addenda.

#### **GC-2.11 PRE-OPENING MODIFICATION OR WITHDRAWAL OF BIDS**

(a) **Procedure** – Bids may be modified or withdrawn by written notice on official company stationery received in the office designated in the Invitation for Bids before the time and date set for Bid opening. A notice of withdrawal or modification to a Bid must be signed in accordance with the requirements of GC-2.06(b). The requirements of this subparagraph may be satisfied by a FAX.

(b) No withdrawal or modifications shall be accepted after the time for Bid opening except as expressly permitted in the Invitation for Bids.

(c) **Disposition of Bid Security** – If a Bid is withdrawn in accordance with this Section, the Bid Security, if any, shall be returned to the Bidder.

#### **GC-2.12 LATE BIDS, LATE WITHDRAWALS, AND LATE MODIFICATION**

(a) **Policy** – Any Bid received at the place designated in the Invitation for Bids after the time and date set for receipt of Bids is late. **Any** request for withdrawal or request for modification received after the time and date set for receipt of Bids will not be honored.

(b) **Treatment** – A late Bid, late request for modification, or late request for withdrawal shall not be considered. Late Bids will be returned to the Bidder unopened.

#### **GC-2.13 OPENING AND RECORDING OF BIDS**

(a) **Opening and Recording** – Bids and modifications shall be opened publicly, at the time, date, and place designated in the Invitation for bids. The name of each Bidder, the total Bid price, and such other information as is deemed appropriate shall be read aloud or otherwise

made available. This information also shall be recorded at the time of Bid opening. The Bids shall be tabulated or a Bid abstract made. The opened Bid shall be available for public inspection at a reasonable time after Bid opening but in any case before Contract award except to the extent the Bidder designates trade secrets or other proprietary data to be confidential. Material so designated shall accompany the Bid and shall be readily separable from the Bid in order to facilitate public inspection of the non-confidential portion of the Bid. Prices, makes, and model or catalog numbers of the items offered, deliveries, and terms of payment shall be publicly available at a reasonable time after Bid opening but in any event before Contract award regardless of any designation to the contrary at the time of Bid opening.

**(b) Confidential Data** – The Engineer shall examine the Bids to determine the validity of any requests for nondisclosure of trade secrets and other proprietary data identified in writing. Confidential, proprietary information, and trade secrets furnished by a Bidder may be disclosed to another County agency if there is a need for the information and may not be disclosed outside of County government except as provided by the Public Information Act or other applicable laws of the State of Maryland.

#### **GC-2.14 MISTAKES IN BIDS**

**(a) Mistakes Discovered Before Opening** – A Bidder may correct mistakes discovered before the time and date set for Bid opening by withdrawing or correcting the Bid as provided in GC-2.11.

**(b) Confirmation of Bid** – If the Engineer knows or has reason to conclude that a mistake may have been made, the Bidder may be required to confirm the Bid. Situations in which confirmation may be requested include obvious, apparent errors on the face of the Bid or a Bid unreasonably lower than the other Bids submitted. If the Bidder alleges mistake, the Bid may be corrected or withdrawn upon written approval of the County Attorney’s Office if any of the following conditions are met:

**(1)** If the mistake and intended correction are clearly evident on the face of the Bid form, the Bid shall be corrected to the intended correct Bid and may not be withdrawn. Examples of mistakes that may be clearly evident on the face of the Bid form are typographical errors, errors in extending unit prices, transposition errors, and arithmetical errors.

**(2)** A Bidder may be permitted to withdraw a low Bid if:

**(A)** A mistake is clearly evident on the face of the Bid form but the intended correct Bid is not similarly evident; or

**(B)** The Bidder submits proof of evidentiary value that clearly and convincingly demonstrates that a mistake was made.

**(3)** In situations where the Purchasing Agent determines that the low Bid submitted is so low due to a demonstrable mistake other than a mistake in judgment, such that

the bidder may incur severe loss if awarded the Contract, and that a potential unconscionable contract would be made, the Bidder may be allowed to withdraw the Bid, subject to forfeiture of the Bid deposit.

(c) **Mistakes Discovered After Award** – Mistakes may not be corrected after award of the Contract except when the Engineer and the Purchasing Agent make a determination that it would be unconscionable not to allow the mistake to be corrected. Changes in price are not permitted.

## **GC-2.15 IRREGULARITIES**

(a) Bids having one or more of the following faults will be considered irregular and may be rejected:

- (1) If the Bid Form furnished by the County is not used or is altered;
- (2) If not prepared as directed in GC-2.06;
- (3) If there is an omission of a necessary word(s) or numeral(s) required to make a price unmistakably clear, as well as any other omission; addition of item(s) not called for;
- (4) Failure to include a price for each item required except in the case of designated alternate pay item(s) or contrary to the conditions of the advertisement;
- (5) If there are additions, conditions or unauthorized alternate Bids;
- (6) If the Bidder adds any provisions reserving the right to accept or reject the Award;
- (7) If not accompanied by a Bid Security when required from Surety guaranteeing that the Payment and Performance Bonds will be furnished if the Bidder is determined to be the low Bidder; or
- (8) If all the required Bid certifications and/or documents are not duly executed.

(b) Minor irregularities –

(1) Minor irregularities or informalities in Bids, as defined below, may be waived if the County determines that it shall be in the County's best interest. The County may either give a Bidder an opportunity to cure any deficiency resulting from a technicality or minor irregularity in his/her Bid, or waive the deficiency where it is to the County's advantage to do so.

(2) When at any public opening of Bids, a Bid appears to be irregular, as herein specified, this fact may be announced when read. Said Bid shall be read as other Bids and then referred to the Engineer for consideration and appropriate action thereon in accordance with these General Conditions, and applicable laws and regulations.

(3) A minor irregularity is one that is merely a matter of form and not of substance or pertains to some immaterial or inconsequential defect or variation of a Bid from the exact requirement of the Invitation for Bids, the correction or waiver of which would not be prejudicial to other Bidders or offerors. The defect or variation in the Bid is immaterial and inconsequential when its significance as to price, quantity, quality or delivery is trivial or negligible when contrasted with the total cost or scope of the supplies or services being procured and the intent and meaning of the entire Bid is clear.

#### **GC-2.16 CANCELLATION OF INVITATIONS FOR BIDS**

(a) Before bid opening, an Invitation for Bids may be canceled in whole or in part when the County determines this action is fiscally advantageous or otherwise in its best interest.

(b) When an Invitation for Bids is canceled before Bid opening, the Bids shall be returned unopened to the Bidders submitting them and notice of cancellation shall be included.

(c) When it is determined before an award but after opening that the Invitation for Bids contains inadequate, deficient or ambiguous specifications; does not provide for consideration of all factors; or the scope of the work needs to be modified; then the bid shall be rejected.

(d) Each Bidder shall be notified of the cancellation/rejection. The notice shall state the reason for such action.

#### **GC-2.17 REJECTION OF INDIVIDUAL BIDS OR PROPOSALS**

(a) A Bid opened and read at any Bid opening may be subsequently rejected if found to be irregular for any of the reasons specified in GC-2.14 and 2.15.

(b) A Bid opened and read at any Bid opening will be subsequently rejected if there is found to be interest by the same individual, partnership, firm or corporation in more than one Bid on a Contract, except that any individual, partnership, firm or corporation may have an interest in a Contract as a Bidder and also be named in other Bids as a Subcontractor.

(c) Any Bid may be rejected in whole or in part when it is in the best interest of the County to do so.

(d) Reasons for rejection of a Bid may include but are not limited to:

(1) The Bid is not responsive i.e., it does not conform in all material respects to the Invitation for Bids;

(2) Unreasonable price(s);

(1) The Bidder submitting the Bid is determined to be non-responsible, or

(2) The Bidder fails to supply information to the Engineer promptly after notification from the Engineer that such information is required in connection with a determination to be made pursuant to this section.

(e) A determination of non-responsibility may be made for, but is not limited to, any of the following reasons:

(1) Bidder debarred by any public body or ineligible to Bid to any public body and the period of debarment or ineligibility has not expired.

(2) The unit prices contained in a Bid are unbalanced.

(3) The omission of a unit price for a bid item.

(4) Evidence of collusion among Bidders.

(5) Inadequate quantity and/or quality of experience, plant, equipment, financing, manpower or other resources required to perform the Contract.

(6) Bidder's workload, which, in the judgment of the County, might hinder or prevent the prompt completion of the subject work if awarded.

(7) Default by the Bidder on other contracts with the County.

(8) Failure to pay or satisfactorily settle all reasonable and just bills due for labor and material on prior or current contracts with the County.

(9) The same person has an interest in more than one Bid on a Contract exclusive of being named by another Bidder as a subcontractor.

(10) Failure to perform satisfactorily on other contracts awarded, and the conditions leading to unsatisfactory performance remain unresolved.

(11) The Bidder is not authorized to conduct business in Maryland.

(12) Any other reason affecting the Bidder's ability to perform or record of business integrity.



(13) Bidder not otherwise qualified and eligible to receive an award under applicable laws and regulations.

(f) Refusal or failure by the Bidder to comply with the County's request for the submission of a Contractor's Qualifications Questionnaire will be cause for rejection of the Bid and for the forfeiture of the Bid Security, which shall become the property of the County not as a penalty but in liquidation of damages sustained.

#### **GC-2.18 REJECTION OF ALL BIDS**

(a) After Bid opening but before award, all Bids may be rejected in whole or in part when the Engineer, with the approval of the Director, determines that this action is fiscally advantageous or otherwise in the County's best interest.

(b) A notice of rejection of all Bids shall be sent to all Bidders, Bids that have been opened shall be retained by the County.

#### **GC-2.19 BID EVALUATION AND AWARD**

(a) **General** – The Contract is to be awarded to the lowest responsive and responsible Bidder whose Bid meets the requirements and evaluation criteria set forth in the Invitation for Bids, and is either the lowest Bid or lowest evaluated Bid. After Bids have been publicly opened and read, the Bids will be audited and reviewed for mathematical accuracy to determine that there are no irregularities as outlined in GC-2.14 and 2.15.

(b) **Sub-Contractor Approval** – The three (3) lowest bidders shall submit a written list of all subcontracts within 48 hours after the bid opening for review for approval by the County.

(c) **Determination of Lowest Bidder** – Bids shall be evaluated to determine which Bidder offers the lowest cost to the County in accordance with the evaluation criteria set forth in the Invitation for Bids. Except as otherwise provided under GC-2.14 Mistakes in Bids:

(1) The written words will govern in the event of a discrepancy between the prices written in words and the prices written in figures.

(2) The unit price will govern in the event of a discrepancy between the unit price Bid and the extended price (product of unit price multiplied by the quantity).

(3) The sum of the extended prices will govern in the event of a discrepancy between the total amount Bid and the extended prices.

(4) If a unit price has been omitted and an extended price is provided, the unit price will be determined by dividing the extended price by the quantity.

(d) The County reserves the right to make the award by Bid Item, or groups of Bid Items, or total Bid if it is in the best interest of the County to do so unless the Bidder specifies in its Bid that a particular or progressive award is not acceptable.

(e) Before any Contract is awarded, the Bidder may be required to furnish a complete statement of the origin, composition and manufacture of any or all materials to be used in the construction of the Work together with samples, which samples may be subjected to the tests provided for in the Specifications to determine their quality and fitness for the Work.

(f) **Award** – Upon determination of the lowest Bidder, review of the Bid for responsiveness and satisfaction that the Bidder is responsible, the Contract may be awarded to that Bidder. A Contract may be awarded to a Bidder offering a higher quality item than that designated in the Invitation for Bids if that Bidder is also the lowest responsive and responsible Bidder. The successful Bidder will be notified (by letter mailed to the address shown on the Bid Form) that his/her Bid has been accepted and that he/she has been awarded the Contract.

(g) A Notice of Award may be rescinded by the County at any time prior to execution of the Contract. After Notice of Award, the County shall forward the formal Contract and other appropriate forms and certifications to the bidder for execution. The Bidder will then execute the Contract and return same, together with fully executed Payment and Performance Bonds, insurance certificates, and any other forms required by the Contract Documents, to the County within ten (10) days after the Notice of Award is sent. After receipt of the properly executed Contract and acceptable Payment and Performance Bonds, the County will execute the Contract and forward a copy to the Bidder. The County will issue a Notice to Proceed followed by the Purchase Order signed by the County Purchasing Agent, which is the official statement that the obligation of funds for construction has been authorized. No Bidder shall withdraw his/her Bid within the time specified in the Bid.

## **GC-2.20 TIE BIDS**

(a) **Definition** – Tie Bids are responsive Bids from responsible Bidders that are identical in price, terms, and conditions and which meet all the requirements and evaluation criteria set forth in the Invitation for Bids.

(b) **Award** – **Unless otherwise specified**, if identical low Bids are received from an in-County and out-of-County Bidder, the award shall be made to the in-County Bidder. If identical low Bids are received from in-County Bidders or from out-of-County Bidders, a drawing shall be conducted, and a witness shall be present to verify and certify the result.

## **GC-2.21 MULTIPLE OR ALTERNATE BIDS**

Unless multiple or alternate Bids are requested in the Invitation for Bids, these Bids may not be accepted. However, if a Bidder clearly indicates a base Bid, it shall be considered for Award as though it were the only Bid submitted by the Bidder.

## **GC-2.22 BID PROTESTS**

(1) A Bidder may deliver a written protest to the Purchasing, within ten (10) days of issuance of award notifications. The written protest shall set forth all particulars supporting the protest and enclose all supporting exhibits and evidence.

(2) The Purchasing Agent shall review the protested decision; examine any additional information provided by the Bidder and respond to the Bidder within seven (7) days of receipt of the protest. The decision of the Purchasing Agent shall be final and not subject to appeal to the fullest extent allowed by law.

## **GC-2.23 POLITICAL CONTRIBUTION DISCLOSURE**

The Proposer, in accordance with Md. Code Ann., State Finance and Procurement Article, Section 17-402, as amended from time to time, shall comply with the political contribution reporting requirements under Title 14 of the Election Law Article, Md. Code Ann., as amended from time to time, to which the Proposer may be subject.

## **GC-SECTION 3 AWARD AND EXECUTION OF CONTRACT**

### **GC-3.01 AWARD OF CONTRACT (See GC-2.19)**

- (a) Written Notice of Award shall be sent to the successful Bidder.
- (b) The County reserves the right to cancel the award of any Contract at any time before the execution of the said Contract by all parties without any liability against the County.
- (c) Unless otherwise specified, the successful Bidder on each Contract advertised by the Department will receive upon award up to five (5) sets of Drawings and Specifications free of charge. Any additional sets required by the Contractor may be purchased at the price stated in the Invitation for Bids.

### **GC-3.02 RETURN OF BID SECURITY**

(a) All Bid Securities, except those of the three (3) lowest Bidders, will be returned immediately following opening and the review of the Bids. The Bid Securities of the three (3) lowest Bidders will be returned following the execution of the Contract and submission and approval of the Payment and Performance Bonds. The Contractor has the right to substitute a Bid Bond for other Bid Security, acceptable to the County, at any time prior to return of the Bid Security.

### **GC-3.03 PERFORMANCE BOND AND PAYMENT BOND REQUIREMENTS**

(a) **Performance and Payment Bonds** – The successful Bidder shall provide to the County a Performance Bond and a Payment Bond, each in an amount equal to at least 100 percent of the Contract price. The form of the Bonds and the security shall be as prescribed by the County. The name of the underwriting agency for said Bond as well as the local contact and phone number shall be shown thereon. The Bonds shall be delivered by the Bidder to the County no later than the time the Contract is to be executed. If the Bidder fails to deliver the required Bonds, his/her Bid shall be rejected, his/her Bid Security shall be enforced, and award of the Contract may be made to the next lowest responsive and responsible Bidder.

(b) Corporations executing Payment and/or Performance Bonds as sureties must appear on the United States Department of Treasury's most current list of approved sureties and must act within the limitations listed therein. In the event that during the performance of the Contract the corporate surety is removed from the Department of Treasury's most current list of approved sureties or its limitation is reduced below the amount of the Payment and Performance Bonds, the Contractor will be in default and will immediately obtain additional or replacement Bonds to the satisfaction of the County.

(c) The Bonds shall be on forms provided by the County.

### **GC-3.04 EXECUTION OF CONTRACT**

(a) The Contract shall be effective only upon receipt by the County of the proper, executed Contract and Performance and Payment Bonds (if required), and execution of the Contract by the County.

(b) After a Notice of Award, as provided in GC-3.01, has been issued to a Bidder, the County shall forward the formal Contract form and the appropriate forms for the Payment and Performance Bonds (if any) to the Bidder for execution. The Bidder will execute the Contract form and return same, together with fully executed Payment and performance Bonds (if any), to the County within ten (10) days after receipt of same. After receipt of properly executed Contract form and Payment and Performance Bonds, (if any), the County will execute the Contract within ninety (90) days and forward the Bidder a copy; provided, however, that the Board has approved the Contract (if such approval is required). If the County fails to execute the Contract and the period of irrevocability has expired, the Bidder may, as his/her sole remedy, withdraw his/her Bid(s).

(c) If the lowest responsible Bidder is not notified of the County's acceptance of his/her Bid within ninety (90) calendar days of Bid opening or the time or date otherwise specified in the contract documents, the Bidder shall have the right to withdraw his/her Bid without penalty.

(d) By executing the Contract, the Contractor represents that he/she understands the Contract Documents, has obtained clarification as to the intent of these documents, has visited the site, familiarized himself with the local conditions under which the Work is to be performed, and correlated his/her observations with the requirements of the Contract Documents. It is assumed the Contractor has obtained, before award of the Contract, clarification of all questions as to the intent of the Contract Documents, and any conflict between two or more items in Contract Documents. Should Contractor fail to obtain such clarification, then the Engineer shall direct work to proceed by the method indicated, specified or required by Contract Documents which will produce the best results, as judged by the Engineer. Such direction by Engineer shall not constitute a basis for any claim for extra cost by Contractor.

### **GC-3.05 FAILURE TO EXECUTE CONTRACT**

(a) Failure of the Bidder to execute the Contract and file acceptable Performance and Payment Bonds within the time aforesaid shall be just cause for the annulment of the Award. The County may then issue an Award to the next lowest responsive, responsible Bidder or the work may be re-advertised and constructed under Contract or otherwise, as the County may decide. The Contractor shall immediately upon demand pay over to the County the difference between the amount of his/her Bid and such larger amount for which the County may, in good faith contract with another party to perform the work covered by Contractor's bid, plus an additional sum of Two Thousand Dollars (\$2,000.00) representing the reasonable approximation of damages suffered by the County for administrative expenses arising out of the Contractor's failure to execute the Contract and/or file acceptable Performance and Payment Bonds. In the event the Contractor fails to make said payment, the County may proceed against the Bid Security and liquidate said Bid Security to the extent necessary to satisfy the demand. In the event the Bid Security is insufficient to fully compensate the County for its demand, the Contractor shall be liable for the unpaid portion of the demand and the County may proceed against the Contractor for the deficiency.

### **GC-3.06 W-9 VENDOR INFORMATION**

(a) Prior to issuing a purchase order or check, the Internal Revenue Service (IRS) requires the County to obtain the Contractor's Taxpayer Identification Number (TIN), which is the Contractor's Social Security number or his/her company Employer Identification Number (EIN).

(b) Upon award of the Contract to Contractors doing business with the Washington County Board of County Commissioners for the first-time, the County Purchasing Department

will transmit a request for completion and return of an IRS Form W-9, Request for Taxpayer Identification Number and Certification. The information will be required for processing Requests for Payment as set forth in GC-9.01(e).

## **GC-SECTION 4 SCOPE OF WORK**

### **GC-4.01 INTENT OF CONTRACT**

(a) The Contractor shall (within specified tolerances) perform all work in accordance with the lines, grades, typical cross sections, dimensions, and other data shown on the Drawings or as modified by written orders including the furnishing of all materials, implements, machinery, equipment, tools, supplies, transportation, labor, and all other things necessary to the satisfactory prosecution and completion of the Project in full compliance with the Contract Documents.

(b) The documents composing the Contract Documents are intended to be complementary, and to describe the construction and completion of the Work. Anything mentioned in the Specifications and not shown on the Drawings and not mentioned in the Specifications shall have like effect as if it is shown or mentioned in both. The intention of the Contract Documents is to include all labor, materials, equipment and other items necessary for the proper execution and completion of the Work and which is reasonably inferable from the Contract Documents to produce the intended results. The terms and conditions of the Contract Documents control over any conflicting terms and conditions of any Purchase Order issued to fund the payments under this Contract.

(c) Words which have well-known technical or trade meanings are used herein in accordance with such recognized meanings. Omissions from the Drawings or Specifications or the incorrect description of details of work that are manifestly necessary to carry out the intent of the Drawings and Specifications or that are customarily performed shall not relieve the Contractor from performing such omitted or incompletely described details of work, but they shall be performed as if fully and correctly set forth and described in the Drawings and Specifications.

(d) In the event the Contractor discovers any discrepancies in the Contract Documents, he/she shall immediately notify the Engineer. The Engineer will then make such corrections and interpretations as may be deemed necessary for fulfilling the intent of the Contract. In the event of any irreconcilable discrepancy between the drawing and figures written thereon, the figures, unless obviously incorrect, will govern over scaled dimensions. In the case of any irreconcilable discrepancy between the Drawings and Specifications, the Drawings govern.

(e) The organization of the Specifications into divisions, sections and articles and the arrangement of the Drawings shall not control the Contractor in dividing the Work among Subcontractors, or in establishing the extent of Work to be performed by any trade.

(f) Written interpretations necessary for the proper execution or progress of the Work, in the form of drawings or otherwise, will be issued with reasonable promptness by the Engineer and in accordance with any schedule agreed upon.

(g) All decisions, corrections and interpretations made by the Engineer pursuant to this paragraph GC-4.01 shall be final.

#### **GC-4.02 GENERAL CONDITIONS CONTROLLING**

In the event of a conflict between these General Conditions and any other provision of the Contract Documents that cannot be reconciled in accordance with GC-4.01, the Special Provisions of the Contract Documents shall be controlling.

#### **GC-4.03 ENTIRE CONTRACT**

(a) The Contract Documents represent the entire and integrated agreement between the parties hereto and supersede all prior negotiations, representations, or agreements either written or oral. The Contract may only be amended or modified in accordance with these General Conditions.

(b) Unless otherwise expressly set forth herein, the parties hereto do not intend to and do not create any third party beneficiaries to this Contract.

#### **GC-4.04 VARIATIONS IN ESTIMATED QUANTITIES**

(a) Where the quantity of a pay item in this Contract is an estimated quantity and where the actual quantity of such pay item varies more than 25 percent above or below the estimated quantity stated in this Contract, an equitable adjustment shall be based upon any increase or decrease in costs due solely to the variation above 125 percent or below 75 percent of the estimated quantity. If the quantity variation is such as to cause an increase in the time necessary for completion, the Engineer shall, upon receipt of a written request for an extension of time within 10 days from the beginning of the delay, or within a further period of time which may be granted by the Engineer before the date of final settlement of the Contract, ascertain the facts and make the adjustment for extending the Completion Date as in his/her judgment the findings justify.

(b) When the Engineer directs adjustments to pay item quantities for normal prosecution of work in pursuing the original scope, a Change Order will be executed prior to exceeding contract quantities for that pay item. The Change Order will be based upon the unit prices Bid for that pay item except that when quantities vary more than 25 percent above or below the estimated quantity stated in this Contract, an equitable adjustment shall be made upon demand of either party as set forth above.

(c) Should any Pay Items contained in the Bid be found unnecessary for the proper completion of the Work contracted, the Engineer may, upon written Change Order to the Contractor, eliminate such Pay Items from the Contract under the terms and conditions described above. Such action will in no way invalidate the Contract, and no allowance will be made for items so eliminated in making final payment to the Contract except as stipulated in this section and/or for such work as may have been done, materials actually delivered and bona fide equipment costs prior to notification of the elimination of the items.

#### **GC-4.05      DIFFERING SITE CONDITIONS**

(a) The Contractor shall within seven (7) days of encountering, and before such conditions are disturbed, notify the Engineer in writing of:

(1) Unknown physical conditions at the site of an unusual nature, differing materially from those ordinarily encountered and generally recognized as inherent in work of the character provided for in this Contract and not discoverable in the Contractor's site investigation required under GC-2.04. Subject to the limitations of 2.04 regarding subsurface conditions, the Engineer shall promptly investigate the conditions, and if he/she finds that such conditions do materially so differ and cause an increase or decrease in the Contractor's cost of, or the time required for, performance of any part of the Work under this Contract, whether or not changed as a result of such conditions, an equitable adjustment shall be made and the Contract modified in writing accordingly.

(b) The Contractor shall immediately notify the Engineer upon encountering hazardous waste.

(c) No claim of the Contractor under this section shall be allowed unless the contractor has given notice as required in (a) above. Any claim for an equitable adjustment arising out of said condition shall be furnished to the Engineer within thirty (30) days from the date of the notice under (a) above and shall proceed in accordance with GC-4.06.

(d) No claim by the Contractor for an equitable adjustment hereunder shall be allowed if asserted after final payment under this Contract.

(e) Failure to provide notice or to submit a claim within the time prescribed herein shall operate as a waiver of any such claim regardless of whether the County incurred or demonstrates any prejudice by the failure to give such notice or to submit such claim.

#### **GC-4.06      CHANGES**

(a) The Engineer may unilaterally, at any time, without notice to the Surety, if any, by written order designated or indicated to be a change order, make any change in



the Work within the general scope of the Contract Documents, including but not limited to changes:

- (1) In the Specifications (including drawings and designs);
  - (2) In the sequence, method or manner of performance of the Work;
  - (3) In the County-furnished facilities, equipment, materials, services, or site;
- or
- (4) Requiring expedition in the performance of the Work.

An order of the Engineer by virtue of being called or referred to as a “change order” does not necessarily constitute a change in the scope of the Contract or in the work required under the Contract. The Contractor should not be entitled to additional compensation, a time extension or other relief for complying with an order of the Engineer if the Contract otherwise requires the Contractor to perform as stated in the order.

(b) Any other act or event or written or oral order including a direction, instruction, interpretation, or determination from the Engineer shall not entitle Contractor to additional compensation unless the Contractor gives the Engineer written notice stating within seven (7) days of the act or event or of the Contractor’s receipt of said order, the date, circumstances, and source of the act or event or of the order and that the Contractor believes that he/she is entitled to additional compensation. Failure to timely provide said notice shall operate as a waiver of any claim by the Contractor for an equitable adjustment, regardless of whether the County incurred or demonstrates any prejudice by the failure to give timely notice. In the event of a dispute between the Engineer and the Contractor as to whether any work was included in the scope of the Contract such that the Contractor would be obligated to provide that Work at no additional cost to the County, the Engineer may order the Contractor under this Section to perform the Work. If the Contractor considers such an order to be a change in the scope of the Contract entitling the Contractor to additional compensation, a time extension, or other relief, the Contractor must provide the notice required by this subparagraph and initiate a claim therefore in accordance with this Section and other contract requirements.

(c) Any proposal for changed work offered by or requested from the Contractor for which a Change Order is necessary shall include a complete breakdown of labor, materials and equipment along with justification for any increase requested in the contract time. When changed work is to be performed by a subcontractor, a copy of the subcontractor’s proposal shall also be included in the submission. When requested by the Engineer, proposals and supporting documentation shall be sent to the Engineer within a reasonable time for his/her review. Any delay resulting from the failure of the Contractor to submit a complete price proposal within a reasonable time shall not be excused or compensated. The Engineer will process a Change Order upon approval of the Contractor’s Bid.

(d) If the Engineer deems that a bona fide emergency exists, he/she may direct in writing that work proceed prior to issuing an executed Change Order. The Engineer will

estimate the quantities and prepare a Change Order for the appropriate contract items. The work shall proceed and the Contractor may file a request for an equitable adjustment as provided by this section.

(e) Except as herein provided, no order, statement, or conduct of the County shall be treated as a change under this clause or entitle the Contractor to an equitable adjustment in the Contract Documents.

(f) Subject to paragraph (g), if any change or order under this clause causes an increase or decrease in the Contractor's cost of, or the time required for, the performance of any part of the Work under this Contract, an equitable adjustment shall be made and the Contract modified in writing accordingly. Provided, however, that no claim for any change under (b) above shall be allowed for any costs incurred more than seven (7) days before the Contractor gives written notice as therein required.

(g) If the Contractor intends to assert a claim for an equitable adjustment under this section, he/she shall, within 30 days after receipt of a written Change Order under (a) above, or a directive under (d) above, submit to the Engineer a written statement setting forth the nature and monetary extent of such claim, including the submission of full particulars of the claim, including a full breakdown of all labor, material, equipment, and subcontractor costs, and full justification for any extension of the Completion Date. As to claims under (b) above supporting data shall be provided with the notice of a claim. As to any supporting data which is not available at the time of the notice, Contractor shall provide with the notice his/her best estimate of the total cost of the claim and further supporting data shall be provided as soon as he/she becomes available. As to any claim for Equitable Adjustment asserted under this Contract, the Contractor shall certify that the claim was made in good faith, that the supporting data are accurate and complete to the best of his/her knowledge and belief, and that the amount requested accurately reflects the contract adjustment for which Contractor believes the County is liable. The failure to timely submit the written statement with full particulars will be deemed a waiver by the Contractor of any right to an equitable adjustment, regardless of whether the County incurred or demonstrates any prejudice by the failure to timely submit the written statement and full particulars, unless this period is extended by the County in writing by the Engineer. The statement of claim hereunder may be included in the notice under (b) above.

(h) When changes involve work for which a Pay Item is included in the Contract, the changed work shall be paid for or a credit provided to the County at the price bid subject to GC-4.04. When changes involve work for which a Bid Item is not included in the Contract, the changed work shall be paid or a credit provided to the County at the unit or lump sum price agreed upon in writing by the Contractor and the Engineer in accordance with GC-4.07. No changed work, except for emergency work, shall be performed until the Contractor has received an executed Change Order. If the Engineer and contractor cannot agree on the amount of the equitable adjustment, the work shall be done in accordance with GC-9.02.

(i) Each Change Order that affects the Contract price shall be subject to the prior written approval of the Purchasing Agent and other appropriate authorities and to prior certification of the appropriate fiscal authority of fund availability and the effect of the Change

Order on the project budget or the total construction cost. If, according to the certification of the fiscal authority, the Change Order will cause an increase in cost that will exceed budgeted and available funds, the Change Order may not be made unless sufficient additional funds are made available or the scope of the Project is adjusted to permit its completion within the project budget.

(j) No claim by the Contractor for an equitable adjustment hereunder shall be allowed if asserted after final payment under this Contract.

(k) Unauthorized work prohibited. Any unauthorized work shall be at the expense of the Contractor and shall not be measured or paid for by the County. At the Engineer's discretion, unauthorized work may be removed and/or replaced within a reasonable time at the Contractor's expense. "Unauthorized work" includes, but is not limited to:

- (1) Work performed by the Contractor before receipt of the Notice to Proceed;
- (2) Work contrary to or in disregard of the instructions of the Engineer;
- (3) Work performed beyond the lines and grades described in the Drawings and Specifications; or
- (4) Extra work performed without written authority.

(l) Contractor may not unilaterally "reserve his rights" to file any claims or requests for extensions of time. The Contractor's rights to additional compensation or time extensions are contingent upon Contractor strictly complying with the Notice, Filing and Certification requirements of the Contract Documents.

**GC-4.07 PAYMENT PROVISIONS – CHANGES, EQUITABLE ADJUSTMENTS, DELAYS**

(a) Unless the Contractor has been directed to proceed under GC-9.02 (Force Account), if the Contractor is entitled to an equitable adjustment, the cost or credit to the County shall be determined in one or more of the following ways:

- (1) By mutual acceptance of a lump sum properly itemized;
- (2) By unit prices stated in the Contract Documents or subsequently agreed upon; or
- (3) By cost plus a fixed percentage fee.

(b) Under (a) (3) above, the Contractor shall be allowed to add the following maximum percentages for overhead and profit to his/her costs for labor and materials:

(1) Twenty percent may be added by the Contractor for overhead and profit for work performed by his/her own forces.

(2) Fifteen percent may be added by the subcontractor for overhead and profit for work performed by the subcontractors; the Contractor may add an additional five percent of the subcontractor's costs for labor and materials.

(3) The County may require the Contractor to produce independent audits to verify overhead and profit rates claimed by the Contractor.

(4) The provisions of (a) and (b) above do not apply to Variations In Estimated Quantities as provided for in GC-4.04.

(c) Payment for materials and equipment shall be in accordance with GC-9.02.

(d) Delay Damages

(1) In the event the Contractor asserts a claim for delay damages it is agreed and understood that the Contractor's compensation shall be limited to direct costs of any such delay. Direct costs may include extended field overhead costs, idle equipment costs as allowed in GC-9.02(c)(6), and the costs of any directed accelerations and/or material escalations, with an allowance of an additional 10% for Contractor's overhead and profit on all direct costs allowed herein. No other damages or compensation or loss whether consequential, direct or indirect shall be allowed, including but not limited to damages for:

(A) Lost profits;

(B) Lost business opportunities;

(C) Extended home office or other overhead other than that specified under this subparagraph;

(D) Loss of bonding capacity;

(E) Lost income;

(F) Lost productivity;

(G) Consequential damages;

(H) Punitive damages;

(I) Interference with contractual relations;

(J) Any like tort damages;

- (K) Claim preparation; or
- (L) Attorney's fees.

(2) Costs claimed, agreed to, or determined pursuant to this section must be allowable, reasonable, lawful, and allocable to the Work and accounted for in accordance with generally accepted accounting principles. Guidance for any determination of whether the costs allowable, reasonable, lawful, allocable, and accounted for in accordance with generally accepted accounting principles will be provided by the Contract Cost Principles and Procedures of the Code of Maryland Regulations currently in effect, which as of July 2008 were located at COMAR 21.09.01.

(e) In no event shall any dispute over the amount to be paid by the County to the Contractor be cause for the Contractor to cease performance of the Work and in all events the Work shall proceed expeditiously pending the resolution of any such dispute as provided for in the Contract Documents.

(f) All requirements for notices of claim and timely submission of, and certification of, claim statements and full particulars found in GC-4.06 and elsewhere in the Contract Documents are a condition precedent to the Contractor's right to delay or any other type of damages or compensation regardless of whether the County has incurred or demonstrates any prejudice by the Contractor's failure to comply with these requirements.

**GC-4.08 UNAUTHORIZED WORK**

(a) Unauthorized work shall be at the expense of the Contractor and shall not be measured or paid for by the County. At the Engineer's discretion, unauthorized work may be ordered removed and/or replaced within a reasonable time at the Contractor's expense.

(b) Unauthorized Work includes, but is not limited to:

- (1) Work performed by the Contractor before receipt of the Notice to Proceed;
- (2) Work contrary to or in disregard of the instructions of the Engineer;
- (3) Work performed beyond the lines and grades described in the Plans and Specifications; or
- (4) Extra Work performed without written authority.

**GC-4.09 FINAL CLEAN UP**

(a) Upon completion of the work specified in the Contract and before final payment will be made, the Contractor shall, without charge therefore, disassemble (or demolish) and

remove all temporary buildings and other structures built by him/her. The construction area and all other adjoining areas, occupied by the Contractor during the construction of said Contract, shall be cleaned of all surplus and discarded materials, spilled materials, excess materials left deposited on the Work as a result of the Contractor's operations, false work, and rubbish. The adjoining areas mentioned above, outside the normal pay limits for seeding, will be reshaped, seeded and mulched, according to the Contract Documents at the Contractor's expense. If the disturbed area was part of an established lawn or was maintained as such, the Contractor shall sod the area in accordance with the Contract Documents at his/her own expense.

#### **GC-4.10 WARRANTY OF CONSTRUCTION**

(a) In addition to any other warranties at law or set out elsewhere in this Contract, the Contractor warrants for one year after final acceptance of the Work, that all Work performed under this Contract conforms to the Contract Documents and is free of any defect of equipment, material, or design furnished, or workmanship performed by the Contractor or any of his/her subcontractors or suppliers at any tier. With respect to any part of the Work, which the County takes possession of prior to final acceptance, the warranty on that Work shall run for a period of one year from the date the County takes possession and has beneficial use of that part of the Work. Under this warranty, the Contractor shall remedy at his/her own expense any such failure to conform or remedy any such defect. In addition, the Contractor shall remedy at his/her own expense any damage to County owned or controlled real or personal property, when that damage is the result of the Contractor's failure to conform to the Contract Documents or any defect of equipment, material, workmanship, or design. The Contractor shall also restore any work damaged in fulfilling the terms of this section. The Contractor's warranty with respect to work repaired or replaced hereunder will run for one year from the date of such repair or replacement.

(b) The County shall notify the Contractor in writing within a reasonable time after the discovery of any failure, defect, or damage.

(c) Should the Contractor fail to remedy any such failure, defect or damage described in (a) above within 15 days after receipt of notice thereof or such longer time as specified in writing by the Engineer, the County shall have the right to replace, repair, or otherwise remedy such failure, defect, or damage at the Contractor's expense.

(d) In addition to the other rights and remedies described in this section, all subcontractors', manufacturers', and suppliers' warranties, express or implied, respecting any work and materials shall, at the direction of the County, be enforced by the Contractor for the benefit of the County. In such case, if the Contractor's warranty under (a) above has expired, any suit directed by the County to enforce a subcontractor's manufacturer's or supplier's warranty shall be at the expense of the county.

(e) The Contractor shall obtain any warranties that the subcontractors, manufacturers, or suppliers would give in normal commercial practice. If directed by the Engineer, the Contractor shall require any such warranties to be executed in writing to the County.

(f) Notwithstanding any other provision of this section, unless such a defect is caused by negligence of the contractor or his/her subcontractors or suppliers at any tier, the Contractor shall not be liable for the repair of any defects of material or design furnished by the County nor for the repair of any damage which results from any such defect in County furnished material or design.

(g) The warranty specified herein shall not limit the County's rights under the Contract Documents and is only intended to create the right and obligation of the Contractor to correct defective items during the warranty period. Nothing contained in the warranty shall be construed to establish a period of limitation with respect to other obligations which the Contractor has under the Contract and shall not be construed to waive or limit any claims against Contractor or his/her Surety arising after the expiration of the warranty period, including without limitation, faulty or defective work, indemnification obligations, and failure of the Work to conform to the Contract Documents. Moreover, nothing contained herein is intended to waive or limit any claim the County has or may have against the Contractor or Surety for latent defects appearing in the Work after the expiration of the warranty period.

(h) To secure the County against the nonpayment of such costs resulting from the Contractor's failure to make repairs during the warranty period as set forth herein, the County may require the Contractor, as a line item, to post a guarantee bond, in a form acceptable to the County, in the amount of five (5) percent of the total value of the Contract, or \$10,000.00 whichever is greater. The guarantee bond shall be posted prior to Final Payment. The guarantee bond must be executed by a surety satisfactory to the County and shall be effective for the longest guarantee period called for in the Contract Documents.

#### **GC-4.11 VALUE ENGINEERING CHANGE PROPOSALS**

(a) The contractor may submit to the Engineer, in writing, Value Engineering Change Proposals (VECP) for modifying the contract Documents for the purpose of reducing the total cost of construction without reducing design capacity or quality of the finished product. The Engineer will then forward the proposal to the Deputy Director with recommended action. The decision to accept or deny the proposal will be made by the Director. The Director will be the sole judge of the acceptability of a VECP. The decision will be final. The County will not consider appeals once the final decision is made. If accepted by the County, net savings resulting from a VECP will be equally divided by the County and the Contractor.

The Contractor may elect to pursue one of the following options.

**Option 1** – Submit the detailed Plans, Specifications and estimate of savings;

**Option 2** – Submit a written concept of the VECP for tentative approval and if accepted, submit the detailed plans, Specifications, and estimate of savings along with all design calculations, reports, studies, etc. for final approval at a later date.

**(b)** Each VECP shall result in a net savings to the Contract cost without impairing essential functions and characteristics of the items or of any other part of the project, including but not limited to service life, reliability, and economy of operation, ease of maintenance, desired aesthetics and safety.

**(c)** As a minimum, the Contractor shall submit the following information before receiving final approval of a VECP.

**(1)** A statement that the proposal is submitted as a VECP.

**(2)** A statement concerning the basis for the VECP and benefits to the County together with an itemization of the Contract items and requirements affected by the VECP.

**(3)** A detailed estimate of the cost under the existing Contract and under the VECP.

**(4)** Proposal Plans, Specifications and recommendations as to how the VECP changes shall be accomplished.

**(5)** A statement as to the time by which an extra work order adopting the VECP must be issued so as to obtain the maximum cost effectiveness. Typically, the County will require four weeks to review and approve a VECP.

**(6)** The Contractor's engineering cost for the VECP.

**(d)** The County will process the VECP in the same manner as prescribed for any other proposal that would necessitate issuance of a Change Order. The County may accept in whole or in part any VECP by issuing a Change Order which will identify the VECP on which it is based. The County will not be liable to the Contractor for failure to accept or act upon any VECP submitted pursuant to these requirements nor for any delays to the work attributable to any VECP PROPOSAL. Until a proposal is effected by Change Order, the Contractor shall remain obligated to the terms and conditions of the existing Contract. If an executed Change Order has not been issued by the date upon which the Contractor's proposal specifies that a decision thereon should be made, or any other date as the Contractor may subsequently have specified in writing, the proposal shall be deemed rejected.

**(e)** The Change Order effecting the necessary Contract modification will establish the net savings agreed upon, will provide for adjustment in the Contract prices and/or Contract time and will indicate the net savings to be equally divided between the Contractor and the County. The Contractor's costs for preparation of the VECP and the County's costs to review and administer the VECP will be deducted from the gross savings. The County reserves the right to include in the Change Order any conditions it deems appropriate for consideration, approval and implementation of the proposal. The Contractor's 50 percent share of the net savings shall constitute full compensation for effecting all changes pursuant to the Change Order.



(f) Acceptance of the VECP and performance of the work therein will not change the Contract time limit as a result of the VECP, unless specifically provided for in the Change Order authorizing the VECP.

(g) The County expressly reserves the right to adopt a VECP for general use in Contracts administered by the County when it determines that the proposal is suitable for application to other contracts. VECPs identical or similar to previously submitted proposals will be eligible for consideration and compensation under this section if such proposals were not previously adopted for general application to other contracts administered by the County. When a VECP is adopted for general use, compensation pursuant to these requirements will be applied only to those contracts awarded and for which the subject VECP has been submitted prior to the date of adoption of the specific VECP.

(h) Proposed changes in the basic design of a bridge or pavement type, or requiring modification to the right-of-way limits, will not normally be considered as an acceptable VECP. Quantity decreases or elimination of any Contract pay items as a result of changing field conditions, errors, etc. will not be considered as an acceptable VECP. If a VECP is based upon or similar to a change in the Plans, Specifications or Special Provisions adopted by the County prior to submission of the VECP, the Director will not accept the proposal.

(i) The requirements herein apply to all VECPs initiated and developed by the Contractor and which are identified as such by the Contractor at the time of his/her submission to the agency; however, nothing herein shall be construed as requiring the Director to consider or approve a VECP submitted by the Contractor.

(j) Subject to the provisions contained herein, the County or any other public agency shall have the right to use all or part of any accepted VECP on other projects without obligation or compensation of any kind to the Contractor.

(k) In the event a VECP is accepted by the County, the provisions of the Contract Documents that pertain to adjustment of Contract unit prices due to alterations of Contract quantities will not apply to the items adjusted or deleted as a result of making the VECP effective by Change Order.

#### **GC-4.12 CONTINGENT ITEMS**

(a) Construction items for which quantities are identified in the “Contingent Fixed Price Items Unit Schedule” or listed in the “Invitation for Bids Form” are established for the purpose of obtaining bids on one or more pay items that may be incorporated into the Project.

(b) The Engineer shall have sole discretion in determining whether and to what extent such items will be incorporated into the Project. The Engineer may order incorporation of such items at any location within the Contract and at any time during the Work. These items may not be located on the Plans. The estimated quantities set out in the Invitation for Bids for such items are presented solely for the purpose of obtaining a representative bid price. The actual quantities

employed may be only a fraction of, or many times the estimated quantity. The requirements of GC-4.04 (Variations in Estimated Quantities) shall apply.

## **GC-SECTION 5 CONTROL OF THE WORK**

### **GC-5.01 AUTHORITY OF THE ENGINEER**

(a) The Engineer shall decide all questions that may arise as to the quality and acceptability of materials furnished and work performed and as to the rate of progress of said work; all questions that may arise as to the interpretation of any or all Drawings and Specifications; and all questions as to the acceptable fulfillment of the Contract on the part of the Contractor.

(b) The Engineer shall determine the amount and quantity of work performed and materials that are to be paid for under the Contract.

(c) The Engineer shall have the authority to suspend the work wholly or in part due to the failure of the Contractor to carry out provisions of the Contract.

### **GC-5.02 CONFORMITY WITH CONTRACT REQUIREMENTS**

(a) All work performed and all materials furnished shall be in conformity with the Contract Documents.

(b) In the event the Engineer finds that the materials or the finished product in which the materials are used or the work performed are not in conformity with the Contract Documents and have resulted in an inferior or unsatisfactory product, the Engineer may order that the work or materials be removed and replaced or otherwise corrected within a reasonable time by and at the expense of the Contractor.

(c) In the event the Engineer finds the materials or the finished project in which the materials are used on the work performed are not in conformity with the Contract Documents but that acceptable work has been produced, the Engineer shall then make a determination if the work shall be accepted. In this event, the Engineer will document the basis of acceptance by a Change Order that will provide for an appropriate equitable adjustment in the Contract price. Any action taken pursuant to this section may not result in an increase of the Contract price.

### **GC-5.03 DISCREPANCIES IN THE CONTRACT DOCUMENTS**

In the event the Contractor discovers any discrepancies in the Contract Documents, he/she shall immediately notify the Engineer. The Engineer will then make such instructions, corrections, and/or interpretations as may be deemed necessary for fulfilling the intent of the

Contract Documents. The decision of the Engineer shall be rendered within a reasonable time and shall be final.

#### **GC-5.04 COOPERATION BY CONTRACTOR**

(a) The Contractor will keep a copy of the Record Counterpart Document and a complete set of all other Contract Documents and shop drawings available on the project site at all times.

(b) The Contractor shall give the work the constant attention necessary to facilitate the progress thereof, and shall cooperate with the Engineer and the Inspectors in every way possible.

(c) The Contractor shall assign to the contract as his/her agent, a competent Project Representative capable of communicating in fluent English, capable of reading and thoroughly understanding the contract Documents, and thoroughly experienced in the type of work being performed, who shall receive instructions from the Engineer or the Engineer's authorized representatives. The Project Representative shall be satisfactory to the Engineer and shall not be changed or replaced except with the written consent of the Engineer, unless the Project Representative proves to be unsatisfactory to the Contractor and/or ceases to be employed by the Contractor. The Project Representative shall have full authority to execute the orders or instructions of the Engineer without delay, and to promptly supply such materials, equipment, tools, labor, and incidentals as may be required. Such management personnel shall be furnished irrespective of the amount of work sublet. Said Project Representatives shall be available at all times when the work is in progress on the project site.

#### **GC-5.05 COOPERATION WITH UTILITIES**

(a) The Contractor shall consider in his/her Bid all of the permanent and temporary utility appurtenances in their present or relocated positions and that no additional compensation will be allowed for delays, inconvenience, or damage sustained by him/her due to any interference from the said utility appurtenances or the operation of moving them.

(b) The Contractor shall have responsibility for notifying all affected utility companies prior to the necessity of performing any work on their utilities and shall cooperate with them in achieving the desired result. All damage to utility facilities caused by the Contractor's operations shall be the responsibility of the Contractor.

(c) Approximate locations of existing utilities are shown on the Drawings. The Contractor shall take all necessary precautions to protect the existing utilities and to maintain uninterrupted service. Any damage incurred due to the Contractor's operation shall be repaired immediately at the Contractor's expense.

(d) The Contractor shall locate existing utilities well in advance of construction activities, clear all utilities by a minimum of six (6) inches, and maintain adequate clearance for utility poles, brace for tunnel as required.

#### **GC-5.06 COOPERATION BETWEEN CONTRACTORS**

(a) Separate Contractors on adjoining or overlapping work shall cooperate with each other as necessary. It is the responsibility of all Contractors to ensure that contiguous work is joined in an acceptable manner. Such cooperation shall include:

(1) Arrangement and conduct of work;

(2) Storage and disposal of materials, etc., by each in such manner as to not unnecessarily interfere with or hinder the progress of the work being performed by other Contractors.

(b) The County and Division shall have the right, at any time, to contract for and perform other work on, near, over or under the work covered by this Contract. In addition, other work may be performed under the jurisdiction of another County agency. In such cases, when a dispute arises among Contractors, the Director will decide which of the Engineers will have jurisdiction over said dispute. The Contractor shall cooperate fully with such other Contractors and carefully fit his/her own work to such other work as may be directed by the Engineer.

(c) In the event of dispute as to cooperation the Director will act as referee. The Contractor will make no claims against the County for any inconvenience, delay, inefficiency, costs, expenses, additional overhead, damages, or loss experience because of the presence and operations of other Contractors.

#### **GC-5.07 AUTHORITY AND DUTIES OF INSPECTORS**

(a) Inspectors shall be authorized to inspect all work done and all material furnished. Such inspection may extend to all or any part of the Work and to the preparation, fabrication, or manufacture of the materials to be used. The Inspector is not authorized to revoke, alter, or waive any requirements of the Contract Documents, nor is the Inspector authorized to approve or accept any portion of the Work. The Inspector is authorized to call the attention of the Contractor to any failure of the Work or materials to conform to the Contract Documents. The Inspector shall have the authority to reject materials or suspend the Work until any questions at issue can be referred to and decided by the Engineer. Inspectors shall perform their duties at such times and in such manner as will not unnecessarily impede progress on the Contract.

(b) The Inspector shall in no case act as foreman or perform any duties for the Contractor, nor interfere with the management of the Work by the latter. Any advice, instruction, direction, or other order which the Inspector may give the Contractor shall not be

construed as binding the Engineer in any way, or releasing the Contractor from fulfilling all of the terms of the Contract Documents.

(c) Where there is disagreement between the Contractor (or his/her representative) and the Inspector, such as refusal by the Contractor to use properly approved material, performing work not in compliance with Plans and Specifications, and/or refusing to suspend work until problems at issue can be referred to and decided by the Engineer, the Inspector will immediately direct the Engineer's attention to the issues of disagreement. If the Contractor still refuses to make corrections, comply, or suspend work (as the case may be), the Engineer will prepare and deliver in writing to the Contractor, by mail or otherwise, a written order suspending the Work or any portion thereof and explaining the reason for such shutdown. As soon as the Inspector is advised of the delivery of the shutdown order, the Inspector shall immediately leave the site of the Work and any work performed during the inspector's absence will not be accepted or paid for and may be required to be removed and disposed of at the Contractor's expense.

#### **GC-5.08 INSPECTION OF WORK**

(a) All materials and each part or detail of the work shall be subject at all times to inspection by the Engineer or his/her authorized representatives and the Contractor will be held strictly to the materials, workmanship, and the diligent execution of the Work in conformity with the Contract Documents. Such inspection may include mill, plant, or shop inspection, and any material furnished under the Contract is subject to inspection at any time. The Engineer or his/her representatives shall be allowed access to all parts of the Work and shall be furnished with such information and assistance by the Contractor as is required to make a complete and detailed inspection.

(b) At the Engineer's request, The Contractor, at any time before acceptance of the Work, shall remove or uncover such portions of the Work as may be directed. After examination, the Contractor shall restore said portions of the Work to the standards required by the Contract Documents. Should the Work thus exposed or examined prove acceptable, adjustments in Contract time and price will be made pursuant to Section GC-4.06 for the uncovering or removing and the replacing of the covering or making good of the parts removed. Should the Work so exposed or examined provide unacceptable, the uncovering, or removing and replacing, shall be at the Contractor's expense.

(c) When the United States Government, the State, or any railroad, corporation, or other public body is to pay a portion of the cost of the Work, their respective representatives shall have the right to inspect the Work under the same conditions as apply to the Engineer and/or the Inspector.

(d) The Contractor is not relieved of any obligation under the Contract because of the approval of non-conforming work by the Inspector, or the failure of an Inspector to detect work that is not performed in accordance with the Contract Documents.

#### **GC-5.09      REMOVAL OF DEFECTIVE WORK**

(a) All work and materials that do not conform to the requirements of the Contract Documents will be considered unacceptable, unless otherwise determined acceptable under the provisions in GC-5.02.

(b) Any unacceptable work found to exist, whether the result of poor workmanship, use of defective materials, or damage through carelessness or any other cause, shall be removed and replaced within a reasonable time with work and materials that shall conform to the Contract Documents or shall be remedied otherwise in an acceptable manner authorized by the Engineer.

(c) Upon failure on the part of the Contractor to comply promptly with any order of the Engineer made under these General Conditions, the Engineer shall have authority to cause defective work to be remedied or removed and replaced and unauthorized work to be removed and to deduct the costs from any monies due or to become due the Contractor under this Contract.

#### **GC-5.10      LOAD RESTRICTIONS**

(a) The Contractor shall comply with all State, County, and local requirements pertaining to speed, size and weight of motor vehicles.

(b) The County may specify in the Contract load restrictions on any road or structure within the vicinity of the Project.

(c) The Contractor shall take into account any and all posted bridges, the crossing of which might be contemplated by the Work. No loads in excess of posted limits will be allowed in the prosecution of the Work on any Contract, unless the required permits are obtained from the appropriate State, County, and local government agencies.

(d) The Contractor shall consider possible detrimental effects of operating heavy paving and grading equipment contiguous to retaining walls, pipe culverts, arches, forms for concrete work, or construction existing prior to this Contract.

(e) The Engineer shall have the right to limit passage of heavy equipment (plus loads) when such passage or usage is causing apparent or visible damage to embankments, paving, structures or any other property.

#### **GC-5.11      MAINTENANCE OF WORK DURING CONSTRUCTION**

(a) The Contractor shall maintain the work during construction and until Final Acceptance. This maintenance shall constitute continuous and effective work prosecuted as required with adequate equipment and forces to the end that all parts of the work be kept in satisfactory condition at all times.

(b) Particular attention shall be given to drainage, both permanent and temporary. The Contractor shall use all reasonable precautionary measures to avoid damage or loss that might result from accumulations and concentrations of drainage water, and material carried by such water and such drainage shall be diverted or removed when necessary to prevent damage to excavation, embankments, surfacing, structures and/or property. Suitable measures shall be taken by the Contractor to prevent the erosion of soil in all construction areas where the existing ground cover has been removed.

(c) The Contractor shall maintain and coordinate his/her activities to the extent necessary to maintain operations of all existing infrastructure affected by the Contract. All cost of maintenance work during construction and before Final Acceptance shall be included in the price Bid (or in the unit price Bid on the various Bid Items as the case may be) and the Contractor will not be paid additional amounts for such work, except as otherwise provided in the Contract Documents.

(d) In the event that the Work is ordered shut down, the Contractor shall maintain the entire Project as provided herein, and shall provide such ingress and egress for local residents or tenants adjacent to the Project, for occupants of the Project, for the County, the Engineer, the Inspectors, and for the general public as may be necessary during the period of suspended work or until the Contract has been terminated for convenience or for default.

(e) On Projects where traffic flow is maintained, the Contractor shall be responsible for repair of all traffic damages to the Work, either partially or totally completed, until such time as the work is accepted by the Engineer. Responsible, as used here, shall mean the responsibility for restoration and the cost thereof unless otherwise expressly provided for in the Contract Documents.

(f) Should the Engineer deem that a bona fide emergency exists and directs Changes in accordance with GC-4.06(d), the Contractor shall continue to maintain the entire Project to every extent necessary to minimize disruptions to all affected infrastructure. The Contractor may file a request for an equitable adjustment as provided for in GC-4.06.

#### **GC-5.12 FAILURE TO MAINTAIN ENTIRE PROJECT**

If the Contractor, at any time, fails to comply with the provisions of GC-5.11 above, the Engineer may immediately notify the Contractor to comply with the required maintenance provisions. In the event that the Contractor fails to remedy unsatisfactory maintenance within 24 hours after receipt of such notice, the Engineer may at his/her sole option immediately proceed with adequate forces and equipment from any source to maintain the Project, and the entire cost of this maintenance will be the responsibility of the Contractor and may be deducted from any monies due the Contractor.

#### **GC-5.13 CLAIMS**

**(a)** All disputes arising under or as a result of a breach of this contract and all requests for an equitable adjustment in the terms of the Contract Documents that are not resolved by mutual agreement shall be resolved in accordance with this section. All requirements for notices of claims and timely submission of, and certification of, claim statements and full particulars found elsewhere in the Contract Documents are a condition precedent to the Contractor's right to proceed under this section regardless of whether the County has incurred or demonstrates any prejudice by the Contractor's failure to comply with these requirements.

**(b)** As used herein, "Claim" means a written demand or assertion by one of the parties seeking, as a legal right, an equitable adjustment including the payment of money, adjustment or interpretation of the Contract Documents, or other relief, arising under or relating to this Contract.

**(1)** A voucher, invoice, or request for payment that is not in dispute when submitted is not a Claim under this Section. However, where the submission is subsequently not acted upon in a reasonable time, or is disputed either as to liability or amount, it may be converted to a claim for the purpose of this section.

**(2)** A Claim by a Contractor shall be made in writing and submitted to the Engineer for decision. A claim by the County shall be set forth in a decision by the Director.

**(c)** Any Claim of the Contractor against the County for an equitable adjustment, including extensions of time, extra compensation, or damages, whether under this Contract or otherwise, shall be conclusively deemed to have been waived by the Contractor, regardless of whether the County has incurred or demonstrates any prejudice, if not submitted with the following documents and within the time specified:

**(1)** The Claim shall be set forth in writing describing the specific fact or event that is the basis of the Claim.

**(2)** The Claim must be accompanied by itemized supporting data supporting the Claim and specifically identifying the actual cost, both direct and indirect, that the Contractor has incurred or will incur by reason of the fact or event that is the basis of the claim for an equitable adjustment.

**(3)** The accuracy of the supporting data shall be certified under GC-4.06 and signed by an officer or principal of the Contractor.

**(4)** Unless an extension has been granted the County, the Claim must be received by the Engineer within thirty (30) calendar days after the fact or event to which the Claim is attributed became known or should have become known to the Contractor.

**(d)** Review and Response – The Engineer will have thirty (30) calendar days from receipt of the Claim to review and respond to the Claim, provided the Contractor has complied with (c) above. In the event that the Engineer does not provide the Contractor with a response



within thirty (30) calendar days of receipt to a properly submitted Claim, the Claim shall be considered denied and the contractor shall proceed with an appeal to the Deputy Director as set forth below or the claim will be forever waived and barred.

**(e) Appeal to the Deputy Director**

(1) The Contractor may appeal the decision of the Engineer to the Deputy Director, in writing, provided the Contractor has complied with GC-5.13(b) and (c) above. The appeal shall contain the complete package of information submitted to the Engineer for consideration and must be filed with the Deputy Director within fourteen (14) calendar days after the Engineer's decision or deemed denial. Unless specifically requested by the Deputy Director, in writing, the Contractor shall not be permitted to submit information that was not offered to the Engineer for review.

(2) The Deputy Director will have thirty (30) calendar days from the actual receipt of a properly submitted appeal as provided for herein to review and respond to the appeal and the Deputy Director shall issue a written decision. In the event that the Deputy Director does not issue a written decision within thirty (30) calendar days of the receipt of a properly submitted appeal, the appeal shall be considered denied and the Contractor shall proceed with an appeal to the Director as set forth below or the Claim shall be forever waived and barred.

**(f) Appeal to the Director**

(1) All references to the "Director" shall be deemed to include the Director or his/her Designee.

(2) The Contractor may appeal the decision of the Deputy Director to the Director, in writing, provided the Contractor has complied with the provisions of GC-5.13 as contained herein. The Contractor's appeal shall contain the complete package of information submitted to the Deputy Director for consideration and must be filed with the Director within fourteen (14) calendar days after the Deputy Director's written decision. Unless specifically requested by the Director, in writing, the Contractor shall not be permitted to submit information that was not offered to the Deputy Director for review.

(3) The Director will have thirty (30) calendar days from the actual receipt of the Contractor's properly submitted appeal as provided for herein to review and respond to the appeal and the Director shall issue a written decision. In the event that the Director does not issue a written decision within thirty (30) calendar days of the receipt of a properly submitted appeal, the appeal shall be considered denied and the Contractor shall proceed to the Circuit Court of Washington County, Maryland as set forth below or the Claim shall be forever waived and barred.

(4) The Director's decision as referenced above shall be the final decision of the County.

(g) The Contractor may appeal the County's final decision by filing a complaint in the Circuit Court for Washington County, Maryland within fourteen (14) calendar days of the County's final written decision. The applicable provisions of the Annotated Code of Maryland and the Maryland Rules shall govern the conduct of the proceedings before the Circuit Court and shall govern all further appeals.

(h) The failure of the Contractor to timely file any appeal described herein shall forever bar and waive the Claim regardless of whether the County incurred or demonstrates any prejudice resulting from the Contractor's failure to timely file any such appeal.

(i) Pending resolution of the Claim, the Contractor shall proceed diligently with the performance of the Contract in accordance with the Engineer's decision.

### **GC-5.14 SHOP DRAWINGS**

(a) **General** – The Contractor shall provide for review and approval submittals such as shop drawings, product data and samples to determine compliance with all applicable laws, statutes, ordinances, codes, orders, rules and regulations; and to determine whether the work, when completed, will be in compliance with the requirements of the Contract Documents. Reviews by the Engineer and/or his/her designated Consultant are for general compliance with the Contract Documents. The reviewer will not assume responsibility for correctness of dimensions or details. The responsibility for dimensions, application and guarantee to conform with the drawings and specifications rest with the Contractor.

(1) Shop drawing review shall be as set forth below to ensure that the equipment, materials and installation methods are in accordance with the construction contract documents.

(2) The Drawings will be supplemented by such drawings as are necessary to adequately control the work. All authorized alterations affecting the requirements and information given on the Drawings shall be in writing and approved by the Engineer. When at any time reference is made to the plans, the interpretations shall be based on the Drawings as affected by all authorized alterations then in effect.

(3) The Contractor shall provide at his/her expense all necessary and required shop drawings and shall have them adequately checked, after which they shall be submitted to the Engineer for review. The Engineer may reject or disapprove such drawings and return them for revisions, in which case the Contractor shall submit new additional or revised drawings as required. No items involving such drawings shall be incorporated in the Work until those drawings have been accepted for use by the Engineer in connection therewith.

(4) Unless otherwise required by the County, all shop drawings shall have a standard title block at lower right corner approximately 4 inches by 8 inches (2 inches for revision column on left side and remaining 6 inches for title) indicating the following information in the order named:

- (A) Name of Contractor (and subcontractor, if applicable)
- (B) Address of above
- (C) Sheet Title (reinforcing details, etc.)
- (D) Name of Facility
- (E) For (Washington County, Maryland)
- (F) By (indicate name of Contractor's official or engineer, or other parties authorized to sign official documents)

(5) The Contractor shall list all County contract numbers and the date the drawings were completed. The left portions of the title block shall be headed "Revisions" and the space used as needed.

(b) At the discretion of the Engineer, shop drawings, and/or calculations for other aspects of the work shall be stamped and signed by a Professional Engineer (P.E.) registered in the State of Maryland who has a minimum of five years of experience in the relevant discipline. The submittal shall include the P.E.'s resume showing evidence of the required experience. The P.E.'s Drawings and design calculations shall evaluate and quality all products and components including manufactured products and proprietary items for their intended service. Acceptance by the Engineer of such drawings and/or calculations shall not in any way relieve the Contractor of the responsibility for the safety and adequacy of the design and construction for the falsework systems and operations, including all components.

(c) **Submittal Process** – The Contractor shall submit the specified number of copies of each shop drawing, submittals and final approval data to the Engineer and his designated consultant for review and approval prior to incorporating materials and/or equipment into the work. Unless otherwise specified, the Contractor shall submit six (6) copies for each item submitted plus the number of copies the Contractor desires to have returned.

(1) Each submittal package shall be accompanied with a formal Letter of Transmittal listing the submittal(s), quantity, date, brief description, and whether the items are transmitted for approval, as requested, etc.

(2) Details of shop drawings, data, and literature for fabricated materials or equipment to be incorporated in the Work shall be submitted to the Consultant for review for general compliance with the Contract Documents before fabrication. The Contractor shall obtain manufacturer's shop drawings, certifications, and other pertinent data for conformance with all requirements of the Drawings and Specifications, and in ample time to permit satisfactory progress of the Work. After completion of such checking and verification by the Contractor, the Contractor shall sign and stamp the drawings, which stamp shall state as follows:

CHECKED BY: \_\_\_\_\_  
(Checker's Name)

\_\_\_\_\_  
(Date)

SIGNED BY: \_\_\_\_\_  
(Contractor's Name)

\_\_\_\_\_  
(Date)

(3) All data, drawings and correspondence from subcontractors, manufacturers or suppliers shall be routed through the Contractor. The Contractor is further advised that the Engineer and his designated representatives will not act as coordinators between suppliers and subcontractors. All required coordination shall be the complete responsibility of the contractor.

(4) At the time of each submission, the Contractor shall call to the Engineer's attention, in writing, any deviations that the shop drawings may have from the requirements of the Drawings and Specifications. The Contractor shall also provide a list prioritizing the submittals for review. In the event that such a list is not furnished by the Contractor, the Engineer shall exercise discretion regarding the order in which submittals are reviewed. This list shall be attached to each applicable submittal.

(5) The Engineer and his designated consultant will review, stamp, and sign each copy of the accepted shop drawings and submittals with "NO EXCEPTIONS TAKEN" or "MAKE CORRECTIONS NOTED".

(6) No extra measurement or payment shall be made for compliance with the requirements of this section of these General Conditions. All costs shall be included in the applicable items.

(7) Corrections or comments made on the shop drawings during review do not relieve the Contractor from compliance with the requirements of the Drawings and Specifications. The County will not be responsible to Contractor for errors or omissions on drawings furnished by the Contractor even though drawings containing such errors or omissions are inadvertently accepted. The Contractor is responsible for confirming and correlating all quantities and dimensions; selecting fabrication processes and techniques of construction; and in performing his work in a safe manner. If the shop drawings deviate from the Contract Documents, the Contractor shall request a deviation from the Contract Documents by submitting a written request accompanying the shop drawings to the Engineer. If this data is not provided with the shop drawings, or is not adequate, the shop drawings shall be rejected and returned to the Contractor.

(8) The Contractor's attention is specifically directed to the fact that no items shall be fabricated, nor equipment or materials ordered nor any construction performed, prior to acceptance of shop drawings and submittals applicable thereto. However, to expedite the project, the contractor may request, in writing, authorization from the Engineer to order critical items before formal acceptance of the shop drawings but not prior to shop drawing submittals. NO items unless so authorized shall be ordered until the Engineer has accepted the drawings.

(9) It shall be the Contractor's responsibility to make all the necessary changes in other items, which result from deviations or changes requested by the Contractor and accepted by the Engineer or his/her consultant, so that all items perform the original requirements and intent of the Contract Documents.

(d) A maximum of two (2) submissions of each submittal will be reviewed, checked, and commented upon without charge to the Contractor. The cost to review submittals (over two submissions) may be deducted from the Contractor's monthly invoice, or from monies retained under the provisions of the Specifications; amounts will be based upon actual additional costs to the County for the additional reviews. It is, therefore, incumbent upon the Contractor to make all modifications and/or corrections as may be required by the Engineer in an accurate, complete, and timely fashion.

## **GC-SECTION 6 CONTROL OF MATERIAL**

### **GC-6.01 GENERAL**

All materials shall meet all quality requirements of the Contract. In order to expedite the inspection and testing of materials, the Contractor shall notify the Engineer in writing of the materials and the sources from which he/she proposes to obtain all materials requiring approval, testing, inspection or certification prior to incorporation into the Work. This submittal shall be made within ten (10) days after receipt of the Notice to Proceed. State and/or Federal funded projects may require approval from one or more State and/or Federal agencies prior to delivery of the material. Such requirements will be set forth in the Special Provisions of the Contract.

### **GC-6.02 APPROVAL OF MATERIAL SOURCES**

(a) **Approval** – The Engineer will inform the Contractor as to the acceptability of each material and his/her source as soon as an evaluation of the sources proposed can be made. No material may be incorporated into the Work until approval of the source has been given. Where delivery of materials to the job site is made prior to approval, such delivery is made at the Contractor's risk and subject to immediate removal, at no cost to the County, if he/she is determined that the source or the material is not acceptable.

(b) **Rejection** – Material sources may be rejected even though prior samples meet the applicable Specifications. Where it is evident to the Engineer that the material tends to be of marginal quality, as compared to the Specification tolerances in one or more of its properties, the material source may be rejected.

(c) **Approval Withdrawn** – All source approvals are made subject to continuing production of materials meeting the Specifications. If the materials do not continue to meet the specifications, the approval of any source may be withdrawn by the Engineer at any time. The

Contactors shall neither have nor assert any claim against the County for an equitable adjustment when such approvals are withdrawn because the materials fail to meet specifications.

**(d) Substitutions.**

(1) After execution of the Contract, the Engineer will consider a written request by the Contractor for the substitution of products in place of those specified, under the following conditions:

(A) The request is accompanied by complete data on the proposed substitution substantiating compliance with the Contract Documents, including project identification and description, performance and test data, references and samples where applicable, and an itemized comparison of the proposed substitution with the products specified or named by addenda, with data relating to contract time schedule, design and artistic effect where applicable, and its relationship to separate contracts.

(B) The request is accompanied by accurate cost data on the proposed substitution in comparison with the product specified, whether or not modification of the contract sum is to be a consideration.

(2) Request for substitution when forwarded by the Contractor to the Engineer, are understood to mean that the Contractor:

(A) Represents that he/she has personally investigated the proposed substitute product and determined that it is equal or superior in all respects to that specified;

(B) Will provide the same guarantee for the substitution as was required for that item originally specified;

(C) Certifies that the cost data presented is complete and includes all related cost under the contract, and that he/she waives all claims for additional costs related to the substitution that subsequently become apparent; and

(D) Will coordinate the installation of the accepted substitute, making such changes as may be required for the Work to be completed in all respects in conformity with the Contract Documents.

(3) Substitutions will not be considered if:

(A) They are indicated or implied on shop drawing submissions without written request as set forth above; or

**(B)** For their implementation they require a substantial revision of the Contract Documents in order to accommodate their use

**(4)** No substitution will be approved without the Contractor remitting to the County the difference between the cost to the Contractor of the substitution and the specified item. The substitution must be less expensive than the specified item. The County reserves the right to disapprove any substitution at its sole discretion.

### **GC-6.03 APPROVAL OF PLANTS AND SHOPS**

**(a)** Five days after receipt of Notice to Proceed, the Contractor shall submit in writing for the Engineer's approval the location and ownership of those plants or fabricating shops at which materials for the project will be processed.

**(b)** The Engineer will inform the Contractor as to the acceptability of the proposed plants or shops within ten (10) days after receipt of the submittal specified in (a) above. No material is to be shipped from these sources until this approval has been given.

**(c)** Plant or shop approvals are made subject to continuing production of materials meeting the Specifications. Where this condition is not met, the approval of any plant or shop may be withdrawn by the Engineer at any time. The Contractor shall have or assert no claim against the County for damages or time extensions when such approvals are withdrawn.

### **GC.6.04 SAMPLES, TESTS, CITED SPECIFICATIONS**

**(a)** All materials used in the Work will be inspected, sampled, and tested in accordance with these requirements and such others as are set forth elsewhere in the Contract Documents where particular reference is made to a specific material. Unless otherwise designated, tests will be made in accordance with the most recently published cited standard tentative or interim methods of AASHTO, the American Society for Testing and Materials (ASTM), the American Water Works Association (AWWA), or others that are current on the date of the Invitation for Bids. These tests will be made by and at the expense of the County unless otherwise expressly required in the Contract Documents.

**(b)** Acceptance testing by the County as described here and elsewhere is not to be considered as a replacement for quality control testing conducted by the Contractor or a manufacturer producing materials for the Contractor. When the Contractor or manufacturer is not providing adequate quality control testing facilities in his/her own behalf, the Engineer may refuse to carry out re-sampling and testing of materials that have been shown to be defective by normal sampling and testing routines. The Engineer may also refuse to resample and test defective materials until and unless corrective action has been taken by the Contractor or manufacturer. The Contractor shall neither have nor assert any claim against the county for damages or time extensions when such approvals are withdrawn.

(c) While it is required that all materials will conform to the specified values for all properties, the Engineer may designate different points of sampling and different sampling intervals for separate characteristics of any material.

(d) The Contractor shall assist in the sampling of materials and make provision for safe and reasonable access.

(e) The Engineer may elect where possible to sample and test lots of material at the point of manufacture. In this case, lots may be given approval and where practical so marked by the Engineer. This procedure assumes that consistent production and appropriate storage, handling and shipping practices shall be maintained by the manufacturer, the hauler and the Contractor. Such approval does not preclude subsequent inspection, sampling and/or testing of materials at the job site with acceptance or rejection being predicated on the results of these later procedures.

#### **GC-6.05 CERTIFICATION OF COMPLIANCE**

(a) The Engineer may permit use prior to sampling and testing of a particular material or assembly accompanied by a Certificate of Compliance from the manufacturer stating that such materials or assembly fully comply with the requirements of the Contract. The Certificate shall be signed by the manufacturer and notarized, and submitted to the Engineer for review and approval prior to the material being incorporated into the Work.

(b) A Material or assembly used on the basis of the manufacturer's Certificate of Compliance may be sampled and tested at any time and, if found not be in conformity with the Contractor requirements, will be subject to rejection whether in place or not, at no cost to the County.

(c) The form and distribution of the manufacturer's Certificate of Compliance will be as approved by the Engineer.

(d) The County reserves the right to refuse permission for use of a material or assembly on the basis of failure to produce a Certificate of Compliance in accordance with the Contract Documents.

#### **GC-6.06 PROJECT CONTROL TESTING**

(a) Materials from approved sources, plants, or shops will be subject to control tests by the Engineer at such locations and with such frequency as he/she deems appropriate.

(b) The point or points of sampling will be those at which materials must meet required physical or chemical properties. It is intended that insofar as is practical, these points will be those in the production process just prior to inclusion into the Work or into combination with other materials. It is also intended that sampling and testing be conducted in such manner



and at such points as to minimize interference with the maintenance of an efficient schedule by the Contractor. Where the nature of the work precludes the attainment of both of these ends simultaneously, the Engineer will designate the points of sampling in a manner so as to ensure compliance with the Contract Documents.

(c) While all materials are required to conform to the specified values for all properties, the Engineer may designate different points of sampling and different sampling intervals for separate characteristics of any material.

(d) The Contractor shall assist in the sampling of materials and make provision for safe and reasonable access.

(e) The Engineer may elect where possible to sample and test lots of material at the point of manufacture. In this case, lots may be given approval and where practical so marked by the Engineer. This procedure assumes that the manufacturer, the hauler and the Contractor shall maintain consistent production and appropriate storage, handling and shipping practices. Such approval does not preclude subsequent inspection, sampling and/or testing of materials at the job site with acceptance or rejection being predicated on the result of these later procedures.

#### **GC-6.07 STORAGE AND HANDLING OF MATERIALS**

(a) Materials shall be so stored as to assure the preservation of their quality and acceptability for the work. Stored materials, even though approved before storage, may again be inspected prior to their use in the Work. Stored materials shall be located so as to facilitate their prompt inspection. Approved portions of the right-of-way, easement and/or project site may be used for storage purposes and for the placing of the Contractor's plant and equipment; such storage areas must be restored to their original condition by the Contractor at his/her expense. The Contractor will be required to furnish the appropriate traffic control devices to warn and protect the public. Any additional space required must be provided by the Contractor at his/her expense.

(b) Materials shall be handled in such a manner as to preserve their quality and acceptability for the work. Handling equipment and hauling vehicles shall be so constructed as to prevent loss, contamination or segregation of materials during or after loading.

#### **GC-6.08 UNACCEPTABLE MATERIALS**

(a) Materials represented by samples taken and tested in accordance with the specified tests and failing to meet required values shall be considered to be defective regardless of prior tests or approvals.

(b) Unless otherwise allowed by the Engineer as set forth below, defective materials shall be removed from the site with any tags, stamps or other markings implying conformance with Specifications removed or obliterated.

(c) Where defects can be corrected, the Contractor may propose such corrective action, as he/she deems appropriate to the Engineer. The Engineer may approve the corrective action but in so doing does not assume responsibility for the success thereof. Retests will be made at the Contractor's expense to determine the acceptability of the material after corrective measures have been taken. No person other than the Engineer may change any provision of the Specifications or the contract without written authorization. The County reserves the right not to accept damaged materials for use in the Work.

(d) The cost of replacing, correcting, and/or removal of defective material will be the responsibility of the Contractor and the Contractor shall not assert a Claim for an equitable adjustment for this cost.

(e) The cost of repairing or replacing other materials damaged by the installation, correction, and/or removal of defective materials will be the responsibility of the Contractor and the Contractor shall not assert a Claim for an equitable adjustment for this cost.

#### **GC-6.09 MATERIAL FURNISHED BY THE COUNTY**

(a) The Contractor shall furnish all materials required to complete the Work, except those specified to be furnished by the County. Materials furnished by the County will be delivered or made available to the Contractor at the point or points specified in the Contract Documents. The cost of handling and placing all materials, after they are delivered to the Contractor, shall be considered as included in the Contract price for the item in connection with which they are used.

(b) The Contractor shall be held responsible for all material delivered to him/her, and deductions will be made from any monies due him/her to make good any shortages and deficiencies, from any cause whatsoever, and for any damage that may occur after such delivery, and for any demurrage charges.

(c) In cases where materials are supplied by the County and incorporated in the Contract Work by the Contractor, materials inspection and acceptance will not be prerequisite for acceptance of the final product as the product pertains to these items.

### **GC-SECTION 7 LEGAL RELATIONS AND RESPONSIBILITY TO THE PUBLIC**

#### **GC-7.01 COMPLIANCE WITH LAWS**

The Contractor hereby represents and warrants that:

(a) He/she is qualified to do business in the State of Maryland and that he/she will take such action as, from time to time hereafter, may be necessary to remain so qualified;

(b) He/she is not in arrears with respect to the payment of any monies due and owing the State of Maryland, or the County, or any department or unit thereof, including, but not limited to the payment of taxes and employee benefits, and that he/she shall not become so in arrears during the term of this Contract;

(c) The Contractor shall keep fully informed of all Federal, State, and local laws, ordinances, rules and regulations and all orders and decrees of bodies or tribunals having any jurisdiction or authority, which in any manner affect those engaged or employed on the work, or which in any way affect the conduct of the work. The Contractor shall at all times observe and comply with all such laws, rules, ordinances, regulations, orders and decrees; he shall protect and indemnify the County and its representatives against any such claim or liability arising from or based on the violation of any law, ordinance, regulation, order or decree, whether by Contractor or his/her employees, subcontractors or suppliers and any tier.

(d) All requirements set forth in Federal and State assistance instruments applicable to this Contract shall be satisfied.

#### **GC-7.02 PERMITS AND LICENSES**

(a) Except as provided in Section 7.02(b), the Contractor shall procure such permits and licenses as may be necessary in order to comply with Federal, State, County, and local laws, ordinances and regulations in performance of the work. All permits issued by the County will be at no charge. The Contractor will be responsible for securing and paying for all other permits, governmental fees, landfill fees and licenses necessary for the proper execution and completion of the Work. He/she shall further give all notices necessary and incidental to the due and lawful prosecution of the Work, including notification to appropriate code enforcement agencies.

(b) Federal permits from the U.S. Corps of Engineers and/or the Environmental Protection Agency will be obtained by the County, and the Contractor shall comply with the requirements of such permits. Permits required from the Maryland State Highway Administration (SHA) and the Maryland Department of the Environment (MDE) will also be obtained by the County and the Contractor shall comply therewith. However, any permits required by these Federal or State agencies which are not required by the Specifications but are desired by the Contractor for temporary structures or other such uses must be applied for and obtained by the Contractor.

(c) The Contractor will not be permitted to move over or operate on any road (except on the road under construction) any power shovels, rollers, concrete mixers, cranes, tractors or any other heavy equipment of weight or dimensions in excess of Maryland Motor Vehicle Law and regulations without first obtaining all necessary permits.

(d) Soil borings or test pits for soil determination in improved roads are not to be excavated by the Contractor, unless permission is obtained from the Washington County Division of Public Works.

### **GC-7.03 RESTORATION OF SURFACES OPENED BY PERMIT**

(a) The right to construct or reconstruct any utility in the road/street and/or to grant permits for same at any time is hereby reserved by Washington County.

(b) Upon the presentation of a duly authorized and satisfactory permit which provides that all necessary repair work shall be paid for by the party to whom such permit is issued, the Contractor shall allow parties bearing such permits to make openings in the highway.

(c) When ordered by the Engineer, the Contractor shall make all necessary repairs due to such openings in an acceptable manner. If such necessary work is part of this Contract, all costs associated with these repairs shall be borne by the Contractor. If it is determined that the costs for such repairs are not the Contractor's responsibility, they will be paid for as extra work under the appropriate unit price items provided for in the Contract. When no such unit price items are provided in the Contract, the costs shall be determined as set forth in GC-4.06.

### **GC-7.04 PATENTED DEVICES, MATERIALS AND HEALTH STANDARDS**

If the Contractor is required or desires to use any design, device, material, or process covered by letters of patent or copyright, it shall provide for such use by suitable legal agreement with the patentee or owner and a copy of such agreement shall be filed with the County. If such agreement is made or filed as noted, the Contractor and the surety shall indemnify and save harmless the County, any affected third party, or political subdivision from any and all claims for infringement by reason of the use of any such patented design, device, materials or process, or any trademark or copyright, and shall indemnify, protect and save harmless the County, its officers, agents and employees with respect to any claim, action, cost, expense, attorney's fees, damages or judgment for patent, trademark or copyright infringement, arising out of purchase or use of materials, construction, supplies, equipment or services covered by this Contract.

### **GC-7.05 FEDERAL AND/OR STATE PARTICIPATION**

When the United States Government and/or the State of Maryland pays all or any portion of the cost of a Project, the Work shall be subject to the inspection of the appropriate federal and/or state agency. Such inspection shall in no sense make the federal and/or state governments a party to this Contract, shall not constitute approval of Work not in conformity with the Contract Documents and will not interfere, in any way, with the rights of either party hereunder.

## **GC-7.06 CONSTRUCTION SAFETY AND HEALTH STANDARDS**

(a) It is a condition of this Contract, and shall be made a condition of each subcontract entered into pursuant to this Contract, that the Contractor and any subcontractor shall not require any laborer or mechanic employed in performance of the Work to work in surroundings or under working conditions that are unsanitary, hazardous, or dangerous to his/her health or safety, as determined under construction safety and health standards and regulations under Federal, State or local law.

(b) The Contractor shall be responsible for posting all appropriate safety notifications such as hard hat requirements, etc.

(c) The Contractor and each subcontractor shall permit inspection without delay and at any reasonable time on any premises where the Work is being performed by a federal or state inspector authorized to investigate compliance with the above-mentioned federal and state statutes and regulations.

(d) The Contractor further agrees to correct any violations found to exist during such inspection within a reasonable time after the issuance of any citation, unless he/she contests the validity thereof through the appropriate administrative and judicial process.

(e) Should the Engineer question the safety of trench shoring(s), he/she may require the Contractor to produce calculations or other supporting documentation and information to satisfy the Engineer's concerns.

## **GC-7.07 PUBLIC CONVENIENCE AND SAFETY**

(a) The Contractor shall at all times conduct the work in such a manner as to ensure the least practicable obstruction to all forms of traffic. Except where required to do so as part of the Contract, he/she shall refrain from disrupting utility operations and service to the least extent reasonable. It shall be provided for the convenience of the general public, tenants and of the residents along and/or adjacent to the improvement.

(b) Equipment and/or materials stored upon the Project shall be placed so as to cause a minimum of obstruction to the public and surrounding operations.

(c) The Contractor shall perform sprinkling or other measure of dust control at the direction of the Engineer.

(d) Unless otherwise specified, the Contractor shall provide and maintain in passable condition such temporary access, roads and bridges as may be necessary to accommodate traffic diverted from the Project under construction, or using the Project under construction and shall provide and maintain in a safe condition temporary approaches to, and crossings of the Project.

(e) All footways, gutters, sewer inlets, water valves and portions of the project adjoining the work under construction shall not be obstructed more than is absolutely necessary.

(f) In the case of utility projects, the Contractor shall provide and maintain such temporary or existing water lines, wastewater lines, and by-pass systems as may be necessary to continue uninterrupted service.

(g) Existing County facilities planned for removal, but which might be of service to the public during construction are not to be disturbed until other and adequate provisions are made. Existing mailboxes shall be maintained or reset in positions accessible to the public and to mail deliveries during construction and subsequent to construction in their final locations in a satisfactory condition.

(h) On County facilities occupied by railroad tracks, temporary platforms for the entrance and exit of passengers to and from the railway cars shall be provided and maintained in an approved manner by the Contractor.

(i) With the exception of fire hydrants marked out-of-service, fire hydrants on or adjacent to the project shall be kept accessible to fire apparatus at all times, and no material or obstruction shall be placed within fifteen (15) feet of any such hydrant. Work closed down for the winter or at any other times shall be left entirely accessible at all points to fire apparatus.

(j) Where the construction lies within rights-of-way, the County has or will obtain permission from the owner of the property to occupy, during construction, Temporary Easements outside the limits of the rights-of-way as shown on the drawings. The Contractor shall not move any equipment or materials in the rights-of-way or Temporary Easements and shall not commence any clearing within rights-of-way until authorized to do so by the Engineer.

(k) Should the Contractor require any temporary easements beyond those shown on the drawings, it shall be his/her obligation to obtain it. Such acquisition shall be in writing and at the Contractor's expense and shall require the Engineer's approval.

#### **GC-7.08 MAINTENANCE OF TRAFFIC**

(a) The purpose of this section of the General Conditions is to provide for the safe and continuous maintenance of traffic (both vehicular and pedestrian) through the project site and to minimize accidents and accident severity while at the same time minimizing inconvenience to the traveling public and the Contractor.

(b) The Contractor will be required to adhere to the Traffic Control Plans, and to the Maryland Manual on Uniform Traffic Control Devices (MMUTCD), latest edition at the time of design. In lieu of complying with the above, the Contractor has the option of preparing and submitting a Traffic Control Plan (TCP) of his/her own design. The TCP developed by the Contractor may not be employed until it is approved, in writing, by the Deputy Director.

(c) The Contractor shall perform all maintenance of traffic work in accordance with the approved Traffic Control Plan (TCP) where applicable, MMUTCD, and Special Provisions to the Contract together with Section 104 of the SHA Standard Specifications for Construction and Materials.

(d) All provisions and methods for maintaining traffic shall comply with the requirements of the Manual of Uniform Traffic Control Devices (MMUTCD), current edition. Also, all materials, devices and flagging procedures shall conform to the requirements of MMUTCD. The Contractor shall provide, maintain in first class condition, and move when necessary and/or directed, all traffic control devices used for the guidance and protection of vehicles.

(e) Traffic must be maintained at all times through the entire length of the Project, and travel lane(s) of the Road may be closed with the approval of the Deputy Director of Public Works (Capital Projects) and/or the SHA District Engineer.

(f) The Contractor shall provide a sufficient number of flagmen and take all necessary precautions for the protection of the Work and safety of the public, all as indicated in the MMUTCD.

**(g) Marking for Work Areas.**

(1) All existing and new signs that may cause driver confusion during various stages of construction shall be removed, covered, or altered subject to the approval of the Engineer.

(2) All existing and new pavement markings that may cause driver confusion during various stages of construction may be removed by any method that the Engineer approves, provided that they are removed and not painted over.

(3) The entire signing and marking procedures shall be reviewed by the Engineer prior to its initiation and shall not be utilized until approved by the Engineer.

(4) No temporary paint striping will be permitted. The Contractor will be required to furnish, install and maintain temporary pavement marking tape which shall delineate lane configuration through each stage of construction.

(5) Pavement marking tape used on this project shall be a type similar to "Scotchlane Highway Grade" for temporary pavement marking or approved equal. The Engineer will determine which tape is to be used for each stage of construction and may limit the Contractor to a specific type at his/her discretion.

(6) The Contractor will continually monitor the condition of the tape and shall direct the immediate removal and replacement of any tape which becomes deteriorated under the use of traffic. The Contractor will be responsible to install the tape in accordance with manufacturer's specifications, and will continually monitor the condition, of the tape. Except in

emergency situations, he/she shall notify the Engineer to approve the immediate removal and replacement of any tape that becomes deteriorated under the use of traffic. Manufacturer's specifications for tape installation shall be submitted to the Engineer for his/her approval.

(7) All pavement markings used shall be temporary and removable along points of traffic lane shifts and detours caused by construction activities. All such markings shall be placed at the time traffic patterns are actually altered and promptly removed at such time traffic patterns are restored to normal lines.

(h) Signs on Windmaster-type sign supports within the limits of the work zone shall be mounted in such manner that the bottom of the sign is at least one foot off the ground.

(i) The channelization devices shall be a minimum of Type II barricades or plastic reflective drums with Type C steady burn lights (2 faces) attached to the inner barricades. The first barricade in either direction a Type "A" low intensity flashing light (2 faces) will have attached to it. All Type III barricades will have 2 Type "A" low intensity flashing lights attached to them.

(j) Traffic cones used in Work areas shall be a minimum of 28" in height with the predominant color being orange in accordance with the MMUTCD. The County will not accept improvisations. Nighttime use of traffic cones shall require two (2) white reflective sleeves 6" on top, 4" on bottom with 2" of separation.

(k) No equipment or materials shall be stored or permitted to stand unprotected where traffic is maintained, or where they would restrict adequate intersection sight distance. At the conclusion of each working day, the Contractor shall store all equipment and materials in protected areas (behind traffic barriers) or remove them to a minimum distance of 30 feet from where traffic is maintained.

(l) Any earth or surfacing material that may be dropped on the surface where traffic is being maintained shall be removed immediately to avoid creating a slippery or hazardous condition.

(m) The Contractor will be required to designate a traffic manager prior to any work being done. The traffic manager will be responsible for the proper implementation of the TCP and for maintaining a regular surveillance over all aspects of traffic control and safety.

(n) The cost of maintenance of traffic shall be included in the appropriate lump sum and unit prices bid. Where no unit prices or lump sum items are provided, the cost will deemed incidental to the project and is to be provided for in other items in the contract. This would include all costs associated with the maintenance of traffic including, but not limited to, the furnishing, placement, maintenance, removal, related labor, tools, equipment and incidentals such as lights, cones, flags, vests, flaggers, traffic manager, and temporary traffic signs, etc.

(o) Unless otherwise expressly stated within the written provisions of the Contract, the Contractor will be permitted to work with the appropriate traffic control and appurtenances



normal working hours with the following exceptions: there will be no work allowed that requires a traffic lane to be closed between the hours of 7:00 a.m. to 9:00 a.m. and 4:00 p.m. to 6:00 p.m., unless the Engineer grants written permission. Lane closure is strictly prohibited within three days prior to or following a County Holiday. Also, full traffic capacity must be restored at the end of each workday, unless approved by the Engineer. See also GC-1.03 – Holidays.

(p) The County reserves the right to modify or explain the methods of traffic control specified herein and to restrict the working hours if, in the opinion of the Engineer, the Contractor's operations are a detriment to traffic.

(q) Failure to comply with this section will result in an immediate order to stop work at no expense to the County.

#### **GC-7.09 MAINTENANCE OF TRAFFIC FOR PRIVATE AND COMMERCIAL PROPERTIES**

(a) The County has obtained various permits, rights-of-way, and construction easements along the line of work as indicated on the Drawings. The Contractor will schedule his/her work so as to cause the least amount of inconvenience to commercial and private properties. Where such properties have more than one entrance to the establishment, the Contractor may close one entrance to the establishment with the approval of the Engineer. Work on the second entrance shall not proceed until the first closed entrance is fully completed, all trenches are capped with crusher run and two (2) inches of cold patch material, and the entrance is opened to traffic. At locations where only one entrance exists, the Contractor will confine his/her work to not more than one-half (1/2) of the entrance. The Contractor will bring the first half to completion before work continues through the remainder of the entrance. The Contractor will maintain at all times continuous vehicular ingress and egress to commercial properties.

(b) Once work is started through a private driveway or entrance, the Contractor will be required to complete the work before ending operations for the day, unless otherwise approved by the Engineer in writing. Unless the Contractor has submitted to the Engineer written approval from the property owner, private driveways or entrances shall not remain closed overnight. Written approval must be provided to the Engineer prior to commencement of work through the driveway or entrance.

(c) There will not be any measurement and payment for this item; the cost will be included in the unit prices Bid for other appropriate Bid Items and considered incidental to the contract.

## **GC-7.10 ACCESS TO RAILROAD RIGHTS-OF-WAY**

**(a) County's Responsibilities** – Where the contractor is required to perform work within the rights-of-way of any railroad, the County has made arrangements with that railroad authority for written approval.

**(b) Contractor's Responsibilities** – Where the Contractor desires to enter onto railroad property or establish a temporary crossing of the railroad property for his/her own convenience and operation, the Contractor shall make his/her own arrangements with the railroad and provide written approval from the railroad authority for the use of any private crossing.

All work on portions of structures over railroad rights-of-way shall conform to all rules and regulations of the owners of the rights-of-way. The Contractor is hereby made responsible for acquiring full knowledge of these rules and regulations and complying therewith with the satisfaction of the owners of the railroad rights-of-way. Where the County has entered into a license agreement or other written arrangement with the railroad authority pertaining to work within the railroad's right-of-way, the Contractor acknowledges the terms and conditions of the agreement and agrees to be bound by these terms and conditions as if fully set forth herein.

**(c) Coordination of Work** – All work to be performed by the Contractor within the railroad right-of-way shall be done in a manner satisfactory to the railroad company and shall be performed at such times and in such manner as not to unnecessarily interfere with the movement of trains or traffic upon the track of the railroad company. The Contractor shall exercise all care and precaution in order to avoid accidents, damage, unnecessary delay or interference with the railroad company's trains or other property, and the Contractor shall indemnify and hold harmless the County for the Contractor's failure to exercise such care and precaution.

**(d) Insurance Requirements** – Prospective Bidders on contracts crossing railroad rights-of-way are advised that the Contractor will be required to obtain, pay for and have approved by the railroad, certain broad forms of public liability and property damage insurance policies as set forth in the Special Provisions, before entering upon the railroad property. In situations where the Contractor requires access to railroad property for convenience, the Contractor shall communicate directly with the railroad authority for written approval. As a general rule, details of such policies are set forth in the Special Provisions; but in the event of an omission from the Special Provisions, the Contractor shall communicate directly with the railroad authority so as to ascertain type of insurance required, if any, and make provisions for same in the proposal.

Unless otherwise provided in the Proposal, costs of insurance policies whether described in the Special Provisions or ascertained by the Contractor will not be provided for in any special item and the cost shall be considered incidental to the several items set forth in the proposal.

## **GC-7.11      PRESERVATION AND RESTORATION OF PROPERTY**

(a) The Contractor shall not enter upon public or private property (outside of the right-of-way or construction easement) for any purpose without obtaining written permission and he/she shall be responsible for the preservation of all public and private property, trees, monuments, signs and markers and fences thereon, and shall use every precaution necessary to prevent damage or injury thereto.

(b) All County signs and markers that are affected by the Work shall be carefully removed when grading operations begin and delivered to the Engineer or stored and protected on-site. The Contractor shall take suitable precautions to prevent damage to underground or overhead public utility structures; shall protect carefully from disturbances or damages all land monuments and property markers until the Engineer has referenced their location; and shall replace them as directed by the Engineer.

(c) The Contractor shall be responsible for all damage or injury to property of any character during the prosecution of the work, resulting from any act, omission, neglect or misconduct in his/her manner or method of executing the Work, or at any time due to defective work or materials, and the responsibility shall not be released until the Work shall have been completed and accepted. When or where any direct or indirect damage or injury is done to public or private property by or on account of any act, omission, neglect or misconduct in the execution of the Work or in consequence of the non-execution thereof on the part of the Contractor, he/she shall restore, at his/her own expense, such property to a condition similar to, or equal to, that existing before such damage or injury, in an acceptable manner. In case of the failure on the part of the Contractor to restore such property or make good such damage or injury, the Engineer may, upon 48 hours notice, proceed to repair, rebuild or otherwise restore such property as may be deemed necessary and the cost thereof will be deducted from any monies due or which may become due the Contractor under this Contract.

(d) **Protection of Geodetic Control Monuments** – It shall be the Contractor’s responsibility to protect all geodetic monuments within the limits of Work. The Contractor shall carefully protect all geodetic control monuments from disturbance or damage until such time as the Washington County Engineering Department has referenced or relocated the monuments. All geodetic control monuments damaged or disturbed by the Contractor shall be replaced by the County at the Contractor’s expense. The Contractor shall coordinate the preservation of all geodetic control monuments with the Washington County Engineering Department.

(e) **Protection of Property Corners** – All property corners not shown on the drawings that are encountered by the Contractor during the course of construction shall be protected from disturbance or damage until the Engineer has referenced their locations. All property corners shown on the plans that are disturbed or damaged by the Contractor shall be reestablished by a licensed surveyor at the Contractor’s expense. Any property corners found during the course of construction which were not shown on the drawings, shall be replaced by the County if disturbed during construction.

**(f) Discovery of Historical Objects** – Whenever historical objects and burial sites of archaeological or paleontological value are encountered during the course of construction, such objects shall not be disturbed. Work shall be stopped and rescheduled in such a manner as to avoid the objects and the Engineer notified, immediately. The Engineer will arrange for an evaluation by the appropriate authorities and for the ultimate disposition of the objects.

**(g) Protection of Existing Landscape Features** – Special attention shall be given to the landscape features of the Work and special care taken to protect the natural surroundings unless otherwise noted on the Drawings. The Contractor shall not disturb, damage, destroy, remove or cut trees or shrubs without authorization. The roots of trees or shrubbery which are not to be cleared, shall not be cut and no heavy equipment of any type shall be allowed to stand under such trees or shrubbery.

**(h) Removal of Trees, Roots and Stumps** – Selected trees within the right-of-way or construction easement, which in the opinion of the Engineer can be saved, shall be protected by the Contractor with boards or planks so that they will not be defaced, bruised, or damaged by the Contractor's equipment or operations. Unless otherwise indicated in the Contract Documents, all trees may be felled in the rights-of-way, utility or drainage easements and construction easements. Trees marked on the Drawings to be protected in the right-of-way or construction easement shall be protected in the manner described above. Stumps, roots, branches and other debris shall be removed from the site unless otherwise noted or directed by the Engineer.

## **GC-7.12 LAND, AIR AND WATER POLLUTION**

**(a)** The Contractor shall incorporate all permanent sediment and erosion control features into the Work at the earliest practicable time as required by the Contract Documents. Temporary pollution control measures will be used by the Contractor to correct conditions that develop during construction that were not foreseen during design; that are needed prior to installation of permanent pollution control features; or that are needed temporarily to control erosion that develops during normal construction practices, but are not associated with permanent control features on the Project.

**(b)** The Contractor's attention is directed to the fact that temporary pollution control may include control measures outside the right-of-way or project site where such work is necessary as a direct result of project construction. The Engineer shall be kept advised of all such off-site control measures taken by the Contractor. This shall not relieve the Contractor of the basic responsibilities for such work.

**(c)** In case of failure on the part of the Contractor to control erosion, pollution, or siltation, the Engineer reserves the right to employ outside assistance or to use his/her own forces to provide the necessary corrective measures. All expenses incurred by the Engineer or the County in the performances of such duties for the Contractor will be the responsibility of the Contractor and may be withheld from monies due to the Contractor. The Contractor will be liable for fines and penalties imposed on the County as a result of his failure to maintain pollution control as set forth in the Contract Documents.

(d) Contractors and suppliers must submit evidence to the County that the governing Federal, State, and local air pollution criteria will be met. This evidence and related documents will be retained by the County for on-site evaluation.

## **GC-7.13 INDEMNIFICATION AND INSURANCE**

### **(a) Indemnification**

(1) The Contractor shall be responsible for all damage to life and property due to his/her activities or those of his/her subcontractors, agents or employees in connection with the services required under this contract.

Further, to the extent permitted by law, the Contractor shall indemnify, defend and hold harmless the County, its officials, agents, employees, successors and assigns against and with respect to any and all losses, damages, suits, claims, judgments and expenses whatsoever (“losses”), including without limitation cost of investigation, litigation and attorney’s fees, arising directly or indirectly from performance of this contract by the Contractor, his/her officers, employees, agents, or subcontractors, or otherwise arising directly or indirectly from the work, except only when such losses are attributable to and proximately caused by the negligence of the County or its officials, employees or agents with no negligence on the part of the Contractor, his/her officers, employees, agents or subcontractors. The foregoing shall apply, without limitation, to losses of all types including destruction or degradation of the environment and all clean-up costs, fines, penalties and other pollution-related items. This indemnification is not to be deemed as a waiver of any immunity, which may exist in any action against Washington County, MD.

(2) In any and all claims against the County or any of its agents or employees or any employee of the Contractor, or any subcontractor, or anyone directly or indirectly employed by any of them or anyone for whose acts any of them may be liable, the indemnification obligation under subsection 1 above shall not be limited in any way by any limitation on the amount or type of damages, compensation or benefits payable by or for the Contractor or any subcontractor under workers’ compensation laws, disability benefits acts, or other employee benefits.

(3) Unless otherwise stated within this Agreement, any property or work to be provided by the Contractor under this Contract will remain at the Contractor’s risk until written acceptance by the County. Until that time, the Contractor will replace, at Contractor’s expense, all property or work damaged or destroyed by any cause whatsoever.

(4) The Contractor shall not disclose any work product created by the Contractor under this Contract to any other parties except as may be authorized in writing by the County as required or permitted by public law.

(5) The Contractor shall be considered for all purposes of this Agreement as an independent contractor, shall not be an agent of the County and shall have no right or authority to enter into any agreements or otherwise bind the County or create any obligations on behalf of the County with other parties whatsoever.

**(b) Insurance Requirements**

(1) **Certificate(s) of Insurance.** The Contractor shall not commence work under the Contract until satisfactory evidence of all required coverage is received by the County. The Contractor shall provide certificates of insurance requiring a 30 day notice of cancellation to the Board of County Commissioners of Washington County in care of the Risk Management Administrator prior to the start of the applicable project.

Approval of the insurance by the County shall not in any way relieve or decrease the liability of the Contractor. It is expressly understood that the County does not in any way represent that the specified limits of liability or coverage or policy forms are sufficient or adequate to protect the interest or liabilities of the Contractor.

All responsibility for payment of any sums resulting from any deductible provisions, corridor, or self-insured retention conditions of the policy or policies shall remain with the Contractor.

(2) Further, the Contractor shall not reduce or cancel or change any of the required insurance coverage without 30 days notice of such change to the Board of County Commissioners of Washington County in care of the Risk Management. Failure to maintain required insurance shall be viewed as a material breach of the Contract by the Contractor.

**(3) Insurance Coverage Required**

Unless otherwise stated in the Special Provisions, the Contractor shall purchase and maintain, at his/her expense until final acceptance of the work by the County, insurance as hereinafter enumerated in policies written by insurance companies admitted in the State of Maryland, having an A.M. Best rating of 'A' or better or its equivalent, and acceptable to the County:

**(A) Workers' Compensation** – The Contractor agrees to comply with Workers Compensation laws of the State of Maryland and to maintain a Workers Compensation and Employers Liability Policy. Minimum Limits Required:

(1) Workers Compensation – Statutory

(2) Employers Liability – \$100,000 (Each Accident)  
\$150,000 (Disease – Policy Limit)  
\$100,000 (Disease – Each Employee)

**(B) Comprehensive General Liability Insurance** – The Contractor shall provide Comprehensive General Liability including Products and Completed Operations. Minimum Limits Required: \$1,000,000 combined single limit for Bodily Injury and Property Damage.

Such insurance shall protect the County, its agents, elected and appointed officials, commission members and employees, and name Washington County on the policy as additional insured against liability, loss or expense due to damaged property (including loss of use), injury or death of any person or persons and for care and loss of services arising in any way, out of, or in connection with or resulting from the work or services performed on behalf of Washington County.

The Contractor is ultimately responsible that Subcontractors, if subcontracting is authorized, procure and maintain, at their sole expense and until final acceptance of the work by the County, insurance as hereinafter enumerated in policies written by insurance companies admitted in the State of Maryland, having an A.M. Best rating of ‘A’ or better or its equivalent, and acceptable to the County.

**(C) Business Automobile Liability** – The Contractor shall provide Business Auto Liability including coverage for all leased, owned, non-owned and hired vehicles. Minimum Limits Required: \$1,000,000 combined single limit for Bodily Injury or Property Damage.

**(D) General Indemnity** – The Contractor shall indemnify, defend and save harmless the Board of County Commissioners of Washington County, its appointed or elected officials, commission members, employees and agents for any and all suits, legal actions, administrative proceedings, claims, demands, damages, liabilities, interest, attorneys fees, costs and expenses of whatsoever kind of nature, whether arising before or after final acceptance and in any manner directly or indirectly caused, occasioned or contributed to in whole or in part by reason of any act, error or omission, fault or negligence whether active or passive by the Contractor, or any one acting under his/her direction, control or on his/her behalf in connection with or incident to his/her performance of the Contract.

**(E) Builder’s Risk Insurance** – The Contractor shall provide Builder’s Risk Insurance with a limit of coverage equal to the construction cost on a replacement cost basis and written on an all-risk policy form. Insurance shall be maintained until the entire project is fully and finally accepted by the County. The Builder’s Risk Policy shall include the County as an additional insured.

- (1) The County is not responsible for any damage or loss of materials stored on or within County-owned facilities. The Contractor shall provide necessary insurance coverage for such losses or shall assume full risk for replacement cost for his/her own materials and those of all subcontractors.
- (2) If the Contract includes the installation of a boiler or heating, ventilating or air conditional equipment, the Contractor shall purchase and maintain from the point of delivery of such equipment onto the site until the project is accepted by the County, a Boiler and Machinery Insurance policy at a limit of not less than the purchase price of such equipment, covering all equipment not covered by the Builders' Risk Insurance described in 'E' before.

**(4) Professional Liability Insurance.** IF ANY ARCHITECTURAL, ENGINEERING, DESIGN, INSPECTION OR PLANNING SERVICES ARE RENDERED, INCLUDING APPROVAL OF SUCH ACTIVITIES OF OTHERS, the following insurance is also required: Professional Liability/Errors and Omissions coverage appropriate to the profession with limits of at least \$1,000,000.00 per occurrence. Such coverage shall contain a retroactive date not later than the effective date of the Consultant's services in relation to this Agreement and shall contain, an agreement to maintain identical insurance, covering incidents occurring or claims made, for a period of three (3) years after substantial completion of the project.

#### **GC-7.14 USE AND POSSESSION PRIOR TO COMPLETION**

(a) The County shall have the right to take possession of or use any completed or partially completed part of the Work. Such possession of or use shall not be deemed an acceptance of any work not completed in accordance with the Contract. While the County is in possession, the Contractor shall be relieved of the responsibility for loss or damage to that portion of the work in possession of the County, other than that resulting from the Contractor's fault or negligence. If such prior possession or use by the County will delay the progress of the work or causes additional expense to the Contractor, the Contractor shall proceed in accordance with GC-4.06 for an equitable adjustment.

(b) At the option of the Engineer, certain completed sections of the work may be opened to traffic or made available for use. In such cases, the completed section will be inspected, tentatively accepted in writing, and the same turned over to the County for maintenance. Such action shall not in any way be construed as Final Acceptance of the Work, or any part of it. No such action shall be construed as a waiver of any of the provisions of these Specifications or the Contract. Upon written authorization by the Engineer, the Contractor may open the Road to traffic and will be relieved of further maintenance of barriers and lights on that portion of the Road.



(c) In the event that the Contractor, with written authorization from the Engineer, suspends work for prolonged periods of time, as a result of winter weather or other reasons, the County, upon written notification by the Engineer, may open a section or sections of a Road in advance of completion or in advance of the Contractor turning the section or sections over to the County for maintenance. Such actions may be taken either for the convenience of the traveling public, or during the winter season, while the work is suspended. The Contractor shall restore the shoulder areas, surfacing, or any portion of the Work which might be disturbed or damaged by use. The restoration work shall be performed at the respective contract unit prices for the items involved. Where unit prices have not been provided for, the work shall be performed in accordance with GC-4.06.

(d) **Builder's Risk Insurance** – The Contractor shall provide “All Risks” Builder's Risk Insurance on the Project, as provided in GC-7.13.

#### **GC-7.15 CONTRACTOR'S RESPONSIBILITY FOR WORK**

(a) Except as otherwise provided in the Contract Documents, until Final Acceptance, the Contractor shall have the charge and care of the Work and shall take every reasonable precaution against injury or damage to any part of the Work or other property by the action of the elements, or from any other cause, whether rising from the execution or from the non-execution of the Work. The Contractor, except as herein elsewhere provided, shall rebuild, repair, restore, and make good all injuries or damages to any portion of the Work or other property occasioned by any of the above causes before Final Acceptance and shall bear the expense thereof. Material lost or structures damaged as a result of faulty temporary drainage during construction or the action of the elements shall be replaced or repaired by the Contractor at no cost to the County. The Contractor shall make good or replace at his/her own expense and as required any County furnished material which may be broken, lost through fire, theft or otherwise damaged, or in any way made useless for the purpose and use intended subsequent to delivery to the Contractor by the County and prior to Final Acceptance of the Work even though such breakage, damage, loss, or uselessness may result from causes beyond the control of the Contractor.

(b) In case of suspension of the Work for any cause whatever, the Contractor shall be responsible for the Project and shall take such precautions as may be necessary to prevent damage to the Work, provide for normal drainage and shall erect any necessary temporary structures, signs, or other facilities at his/her expense. During such period of suspension of Work, the Contractor shall properly and continuously maintain in an acceptable growing condition all living material in newly established plantings, seeding and sodding furnished under this Contract, and shall take adequate precautions to protect new growth and other important vegetative growth against injury.

(c) The Contractor shall be responsible to the County for the acts and omissions of all his/her employees and all Subcontractors, their agents and employees and all other persons performing any of the Work under a contract with the Contractor.

(d) The Contractor shall supervise and direct the Work, using his/her best skill and attention. It shall be solely responsible for all construction means, methods, techniques, sequences and procedures and for coordinating all portions of the Work under the Contract Documents.

#### **GC-7.16 CONTRACTOR'S RESPONSIBILITY FOR UTILITY PROPERTY AND SERVICES**

(a) At points where the Contractor's operations are adjacent to properties of railway, telegraph, telephone and power companies, public/private utilities, or are adjacent to other property, damage to which might result in expense, loss or inconvenience, the Contractor shall not commence work until he/she has made all arrangements necessary for the protection thereof.

(b) The Contractor shall cooperate with the owners of any underground or overhead utility lines in their removal and rearrangement operations in order that these operations may progress in a reasonable manner, that duplication or rearrangement work may be reduced to a minimum and that services rendered by those parties will not be unnecessarily interrupted.

(c) In the event of interruption to utility services as a result of accidental breakage or as a result of being exposed or unsupported, the Contractor shall promptly notify the proper authority and shall cooperate with the said authority in the restoration of service. No work shall be undertaken around fire hydrants until provisions for continued service have been approved by the Washington County Division of Emergency Services and the utility owner.

#### **GC-7.17 PERSONAL LIABILITY OF PUBLIC OFFICIALS**

In carrying out any of the provisions of the Contract Documents, or in exercising any power or authority granted by the County to the Engineer and other authorized representatives by or within the scope of the Contract Documents, there shall be no liability upon the County's authorized representatives either personally or as officials of the County, it being understood that in all such matters they act solely as agents and representatives of the County.

#### **GC-7.18 NOTICES AND WAIVER OF LEGAL RIGHTS**

(a) The County shall not be precluded or stopped by any measurement, estimate, or certificate made either before or after completion and acceptance of the Work payment therefore, from showing the true amount and character of the Work, nor from showing that any such measurement, estimate, or certificate is untrue or is incorrectly made, nor from showing that the Work does not in fact conform to the Contract Documents. The County shall not be precluded or stopped, notwithstanding any such measurement, estimate or certificate and payment in accordance therewith, from recovering from the Contractor or the surety, or both, such damage as it may sustain by reason of the Contractor's failure to comply with the terms of the Contract Documents. Neither the acceptance by the County, or any representative of the County, nor any

payment for or acceptance of the whole or any part of the Work, nor any extension of time, nor any possession taken by the County, shall operate as a waiver of any portion of the Contract Documents or of any power herein reserved, or of any right to damages.

(b) A failure to provide a required notice or to submit a claim or appeal within the time prescribed in the Contract Documents shall operate as a waiver of any such claim regardless of whether the County incurred or demonstrates any prejudice by the failure to give such notice or to submit such claim or appeal.

(c) The waiver of any breach of the Contract Documents shall not be held to be a waiver of any other or subsequent breach. Any waiver by the County of a requirement of the Contract Documents, including without limitation a requirement that a notice be made in writing or a submission be made within a certain time, shall not operate as a waiver of the same or any other requirement of the Contract Documents in any other circumstance or at any other time. The County need not incur or demonstrate prejudice in order to assert that a waiver of the Contractor's rights or claims results from the Contractor's failure to comply with any provision of the Contract Documents when the Contract Documents provide for such waiver of any right or claim.

#### **GC-7.19 CHOICE OF LAW, FORUM**

**The Parties hereby agree that:**

(a) This Contract was made and entered into in Maryland, and under the laws of Maryland.

(b) The law of Maryland (exclusive of its choice of laws rules) shall govern the resolution of any issue arising in connection with this Contract, including, but not limited to, all questions concerning the validity of this Contract, the capacity of the parties to enter therein; any modification or amendment thereto; and the rights and obligations of the parties hereunder.

(c) The exclusive venue and jurisdiction for any litigation arising out of or related to the Contract Documents is the Circuit Court for Washington County, Maryland. Prior to commencing litigation, the Contractor must exhaust all remedies and appeals applicable to the claim or dispute as provided in the Contract Documents as a condition precedent to proceeding with litigation. The Contractor's failure to exhaust all remedies and appeals applicable to the claim or dispute will operate as a waiver of said claim or dispute and will forever bar said claim or dispute, regardless of whether the County incurred or demonstrates any prejudice by the failure to exhaust the remedies and appeals.

(d) Notwithstanding anything in these General Conditions to the contrary, all appeals or litigation arising out of or related to the Contract Documents must be commenced within fourteen (14) calendar days after the County's final decision giving rise to the Contractor's claim. The failure of the Contractor to timely file any appeal or litigation shall forever bar and waive the claim regardless of whether the County incurred or demonstrates any prejudice resulting from the Contractor's failure to timely file the appeal or litigation.

## **GC-7.20      AUDIT AND RETENTION OF RECORDS**

(a) The Contractor and his/her subcontractors and suppliers at any tier shall retain and maintain all records and documents relating to this Contract, including, but not limited to, estimates, cost or pricing data, payrolls, reports and inspections, relating to this Contract for three years after Final Acceptance, and shall make such documents available for inspection and audit by authorized representatives of the County, including the Engineer or his/her designee, at all reasonable times, including during the time of performance of the Contract as may be necessary for any purpose including pricing and cost verification of any Contractor claim.

(b) In the event the County or the Contractor initiates a claim, Contractor and his/her subcontractors or suppliers at any tier shall retain the records set forth in (a) above until the expiration of the aforesaid three-year period or until final, non-appealable resolution of the claim, which ever is later.

(c) The Contractor shall include the provisions of paragraph (a) in every subcontract for the Work.

(d) If Contractor, or his/her subcontractors or suppliers, fail to retain the records set forth herein for the period of time required by this Section, Contractor shall not be entitled to any damages, compensation or equitable adjustment (including time extensions) for any claims based upon information available from or which might be verified by records that have not been retained.

## **GC-7.21      USE OF EXPLOSIVES**

(a) The use of explosives will not be permitted adjacent to or on any existing structures unless authorized in writing by the Engineer. When the use of explosives is permitted, the Contractor shall use the utmost care so as not to endanger life or property. He/she shall exercise extreme caution with the number and size of the charges. The Contractor shall provide for the safeguarding of the traveling public and adjacent properties while using explosives. Such precautions shall include, but not be limited to, a sufficient number of watchpersons, flag persons, signs, etc., to warn motorists during periods of blasting. All explosives shall be stored in a secure manner, and all such storage places shall be marked clearly – “Dangerous Explosives”- and shall be in care of competent watchpersons at all times. Explosives shall be stored and handled in conformity with the provisions of the statutes of the State of Maryland and local laws and ordinances.

(b) **Notifications** – The Contractor shall notify each public utility company having structures in proximity to the site of the Work of his/her intention to use explosives, and such notice shall be given sufficiently in advance to enable the companies to take such steps as they may deem necessary to protect their property from damage. Such notice shall not relieve the Contractor of his/her responsibility for any damage resulting from his/her blasting operations. The Contractor shall notify the Engineer of his/her intention to use explosives, in sufficient time for that agency to schedule its operations.

(c) **Licensed Employees** – Expert powder men licensed by the State Fire Marshall or authority having jurisdiction shall be employed by the Contractor for the handling and use of explosives, and all their work shall conform to the requirements of the State Fire Marshall. The authorization by the Engineer for the use of explosives shall not relieve the Contractor of his/her full responsibility for damages that may occur.

## **GC-SECTION 8 PROSECUTION AND PROGRESS**

### **GC-8.01 SUBCONTRACTING**

(a) All subcontractors are subject to the County's written approval as specified in Section GC-2.19 BID EVALUATION AND AWARD.

(b) The Contractor shall incorporate by reference or otherwise include these General Conditions in every subcontract issued pursuant to or under the Contract.

(c) The Subcontractors who are named by the Contractor subsequent to the Bid opening and approved by the County and those approved when subsequently submitted shall perform the portions of the Work for which approval has been given by the County. Requests for permission to sublet, assign or otherwise dispose of any portion of the Contract shall be in writing and include the item number or numbers, the dollar value, and the percentage of the original contract value. Each request for permission to sublet, assign or otherwise dispose of any portion of the Contract must be accompanied by written consent from the Contractor's Surety. The Contractor shall give assurance that the minimum wage for labor, as stated in his/her Bid, shall apply to labor performed on all work sublet, assigned or otherwise disposed of in any way.

(d) The County will not approve subletting portions of items except in the case of specialty items such as the erection of structural steel, painting, or such portions of items that are distinct and identifiable and that have been approved by the Engineer.

(e) Once a Subcontractor has been approved by the County and Surety for the performance of certain contract items of Work, the Contractor shall not substitute another Subcontractor, unless the Contractor requests a change in writing giving the reasons the change is sought and the substitute proposed. If a Subcontractor does not perform to the satisfaction of the Contractor, the Contractor may perform the Work with his/her own forces or request that another Subcontractor, mentioned by name, be substituted. The County will approve the change if the County determines that the change is in the best interest of the County.

(f) Roadside production of materials shall be considered as "subcontracting", unless performed by the Contractor. This is construed to include the production of crushed stone, gravel and/or other materials by means of portable or semi-portable crushing, screening or

washing plants, established or reopened in the vicinity of the Work, for the purpose of supplying materials to be incorporated into the Work on a designated project or projects.

**(g) Anti-Kickback Regulations**

(1) The Anti-Kickback Regulations issued by any department, agency, or branch of the federal, state or local government are applicable to this Contract. The Contractor shall comply with these regulations, and any amendments or modifications thereof and shall cause appropriate provisions to be inserted in subcontracts to ensure compliance therewith by all Subcontractors, and shall be responsible thereunder, except as the applicable department, agency, or branch may specifically provide for reasonable limitations, variations, tolerances and exemptions from the requirements thereof. In lieu of mailing affidavits required by the Anti-Kickback Regulations to the department, agency, or branch furnishing financial aid on this Project, the Contractor shall submit all such affidavits promptly, as specified, to the County or to a representative designated by the County.

(2) The County, or its representative, may withhold or cause to be withheld from the Contractor so much of the accrued payments or advance as may be considered necessary to pay laborers and mechanics employed by the Contractor or any Subcontractor on the work the full amount of wages to which they are entitled under their contracts of employment. In the event of failure to pay any laborer or mechanic employed or working on the site of the Work, all or part of the wage to which he/she is entitled under this contract of employment, the County, or its representative, may, after written notice to the Contractor, take such action as may be necessary to cause the suspension of any further payment, advance, or guarantee of funds until such violations have ceased.

(3) Payroll records shall contain the information and be preserved as required by the Anti-Kickback Regulations. The Contractor shall make his/her employment records available for inspection by authorized representatives of any federal, state, or local government and shall permit such representatives to interview employees during working hours on the job.

(4) The Contractor shall insert in each of his/her subcontracts the provisions set forth in the foregoing clauses and such other stipulations as any federal, state, or local government may require by appropriate instructions.

(5) A breach of stipulations (1) through (4) may be grounds for termination of the Contract.

(h) The Contractor shall not require as a condition to any executed agreement to provide labor and/or materials to the Project, that a Subcontractor waive the right to sue on or collect from the Payment Bond. The Contractor shall prohibit his/her Subcontractor from requiring, as a condition to any executed agreement to provide labor and/or materials to the Project, that any lower tier Subcontractor waive the right to sue on or collect from any Subcontractor's bond and/or the Payment Bond. The parties expressly intend for all Subcontractors to be third party beneficiaries of this subsection and all Subcontractors can enforce this provision in any appropriate proceedings.

## **GC-8.02 NOTICE TO PROCEED**

After the Contract has been executed, the County will issue to the Contractor a “Notice to Proceed,” which will stipulate when the Contractor is expected to begin work. The specified Contract Time shall begin on the date stipulated in the Notice to Proceed or, if an earlier start is authorized in the Notice to Proceed, on the day work (other than the erection of the inspection office, construction stakeouts, and/or mobilization) actually starts. Work done prior to receipt of the Notice to Proceed, including erection of traffic control, is unauthorized and may not be measured, inspected, or paid for.

## **GC-8.03 PROSECUTION OF THE WORK – COMMENCEMENT – TIME**

(a) The Contractor shall begin work promptly within the time specified by the Engineer and shall notify the Engineer at least five (5) days before starting work.

(b) After commencing work, the Contractor shall prosecute the Work continuously on all acceptable days without stoppage until Final Acceptance.

(c) Should the prosecution of the Work for any reason be discontinued, the Contractor shall notify the Engineer of his/her intention to stop and shall also notify the Engineer at least 24 hours in advance of resuming operations. Said notification shall be confirmed in writing.

(d) The Contractor shall do all the work and furnish all the labor, materials, tools and appliances necessary or proper for performing the Work, in the manner called for by the Contract Documents within the Contract Time; except such as are hereinafter specified as being furnished by the County. He/she shall complete the entire Work, including any work included in Change Orders, at the prices established therefore, to the satisfaction of the Engineer, in accordance with the Contract Documents.

(e) The Contractor shall complete the Work contracted for in an acceptable manner within the number of working days or calendar days as stated in the Contract Documents.

(f) In the unusual event that a Contract is based on Working Days, the Engineer will make available each week to the Contractor a record showing the number of days charged to the Contract for the preceding week and the number of days specified for completion of the Contract. The Contractor will be allowed one week in which to protest and thirty (30) days in which to file a written statement, setting forth in what respects the time charged by the Engineer is incorrect for the week in question. Otherwise, the record will be deemed to have been accepted by the Contractor.

(g) The number of days for performance allowed in the Contract as awarded is based on the Bid quantities. If satisfactory fulfillment of the Contract with extensions and increases authorized under the Contract Documents shall require the performance of work in greater quantities than those set forth in the Bid, the Contract Time allowed for performance shall be

adjusted in an equitable manner based on the quantities, costs and the nature of the work involved pursuant to the procedures in GC-4.06.

**(h)** Under certain conditions, the Contractor may be granted permission or ordered to suspend operations as noted in Section GC-8.08. During such periods, if the Contractor elects and is permitted to do any work, the time charged shall bear the same ratio to the total time allowed for the completion of the Work, as the value of the work done during such time bears to the total value of the original Contract value. However, the resultant number of days to be charged for any particular month will not exceed the number of calendar days for that month, excluding Saturdays, Sundays or official holidays on which no work was performed by the Contractor.

**(i)** Time used in performing work of an emergency nature ordered by the Engineer for the convenience of the traveling public or for the production or delivery of materials for storage, if performed during the period of suspension, will not be charged as working days against the Contract Time.

**(j)** An exception to GC-8.10(b) will be those landscaping items on which work is restricted to specified seasons. When Final Acceptance is being deferred pending completion of those landscaping items on which work is not permissible at the time because such work is currently out of season, and for no other reason, no time will be charged against the Contractor until such time as he/she is again permissible to proceed with such work.

#### **GC-8.04      PROGRESS SCHEDULE**

**(a)** Within fifteen (15) days after Notice to Proceed, the Contractor shall furnish a "Progress Schedule" for the Engineer's review and acceptance in the form required by the Contract Documents showing the proposed order of work and indicating the time required for the completion of the Work. The progress schedule shall be used to establish major construction operations and to check on the progress of the Work. The Engineer's acceptance of any schedule shall not be deemed to modify any time requirements in the Contract Documents. The Contractor shall submit revised progress schedules on a monthly basis thereafter with each the request for payment. If the Engineer does not accept the submitted progress schedule, the Contractor, within ten (10) days of receipt of written notice of non-acceptance, shall submit a revised progress schedule for review and acceptance.

**(b)** If the Contractor fails to submit the progress schedule or revised progress schedule within the required time or if the progress schedule is not accepted, the Engineer may withhold approval of progress payment estimates until such time as the Contractor submits the required progress schedules or may recommend termination of the Contract for default.

**(c)** If, in the opinion of the Engineer, the Contractor falls significantly behind the approved progress schedule, the Contractor shall take any and all steps necessary to improve his/her progress. This may require the Contractor to increase the number of shifts, initiate or increase overtime operations, increase days of work in the work week, or increase the amount of



construction plants, or all of them. The Engineer may also require the Contractor to submit for approval supplemental progress schedules detailing the specific operational changes to be instituted to regain the approved schedule, all without additional cost to the County.

(d) Failure of the Contractor to comply with the requirements of the Engineer under this provision shall be grounds for determination by the County that the Contractor is not prosecuting the Work with such diligence as will insure completion within the time specified. Upon such determination, the Director may terminate the Contractor's right to proceed with the Work, or any separable part thereof, in accordance with GC-8.09.

(e) Acceptance by the County of a progress schedule showing completion of the Work on an accelerated basis shall not be construed as a waiver of the Contract time specified in the Contract Documents. Any accelerated progress schedule accepted by the County shall not form the basis of a delay or acceleration claim by the Contractor.

#### **GC-8.05 LIMITATIONS OF OPERATION**

(a) **Sequence of Work** – The Contractor shall conduct the Work at all times in such a manner and in such sequence as will assure the least interference with the public. The Contractor shall begin work at such points as may be specified in the Contract Documents and shall thereafter prosecute the Work at such points and in such order as may be prescribed therein.

(b) **No Work Without Inspection** – No work requiring the presence of an Inspector will be permitted on Sunday or on legal holidays, except in cases of emergency, without written permission of the Engineer.

(c) **Work On Legal Holidays** – If the Contractor desires to work upon any Sunday or legal holiday he/she shall provide written notification to the Engineer at least two (2) week days in advance. He/she shall indicate the nature of the work and the location where the work will be conducted.

(d) **Emergency Work** – In the event of an emergency, the Contractor may work provided verbal consent is obtained from the Engineer prior to performing the work.

#### **GC-8.06 CHARACTER OF WORKMEN, METHODS AND EQUIPMENT**

(a) The Contractor shall employ personnel with sufficient command of the English language to comprehend spoken instructions and communicate with all parties involved.

(b) The Contractor shall employ sufficient labor and equipment for prosecuting the several classes of Work to full completion in the manner and time required by the Contract.

(c) Workmen must have sufficient skill and experience to perform properly the work assigned to them. All workmen engaged in special work or skilled work shall have sufficient

experience in such work and in the operation of the equipment required to perform all work properly and satisfactorily.

(d) Any person employed by the Contractor or by any Subcontractor who, in the opinion of the Engineer, does not perform his/her work in a proper manner or is intemperate or disorderly shall, at the written direction of the Engineer, be removed forthwith by the Contractor or Subcontractor employing such person, and shall not be employed again in any portion of the Work without the written approval of the Engineer.

(e) Should the Contractor fail to remove such person or persons as required above, or fail to furnish suitable and sufficient personnel for the proper prosecution of the Work, the Engineer may withhold requests for payment that are or may become due on the Contract until a satisfactory understanding has been reached.

(f) Equipment to be used on the Work shall meet the requirements of the Work and produce a satisfactory product in conformity with the Contract Documents. The Engineer may order the removal and require replacement of any unsatisfactory equipment.

(g) When the methods and equipment to be used by the Contractor in accomplishing the Work are not prescribed in the Contract Documents, the Contractor is free to use any methods or equipment that he/she demonstrates to the satisfaction of the Engineer will accomplish the Work in conformity with the Contract Documents.

(h) When the Contract Documents specify that the construction be performed by the use of certain methods and equipment, such methods and equipment shall be used unless others are authorized by the Engineer in writing. If the Contractor desires to use a method or type of equipment other than those specified in the Contract, he/she may request authorization from the Engineer to do so. The request shall be in writing and shall include a full description of the methods and equipment proposed to be used and an explanation of the reasons for desiring to make the change. If approval is given, it will be on the condition that the Contractor will be fully responsible for producing construction work in conformity with the Contract Documents. If, after trial use of the substituted methods or equipment, the Engineer determines that the Work produced does not meet Contract Documents, the Contractor shall discontinue the use of the substituted method or equipment and shall complete the remaining construction with the specified methods and equipment. The Contractor shall remove all deficient Work and replace it with Work of specified quality, or take such other corrective action as the Engineer may direct. Unless approved under GC-4.11, no equitable adjustment to the Contract will be made as the result of authorizing a change in methods or equipment under these provisions.

#### **GC-8.07 ILLEGAL IMMIGRANTS**

(a) The Contractor shall comply with the Immigration and Nationality Act (INA) which includes provisions addressing employment eligibility, employment verification, and nondiscrimination. Under the INA, the Contractor may hire only persons who may legally work in the United States (i.e., citizens and nationals of the U.S.) and aliens authorized to work in the

U.S. The Contractor shall verify the identity and employment eligibility of anyone employed or to be employed, including completion of the Employment Eligibility Verification Form (I-9). The Contractor shall establish appropriate procedures and controls to insure that no services under this Contract will be performed by any worker who is not legally eligible to perform such services or for employment.

(b) Failure by the Contractor or his/her Sub-Contractors to comply with the provisions of GC-8.07 (a) will be grounds for termination of the Contract.

#### **GC-8.08      SUSPENSION OF WORK**

(a) The Engineer may unilaterally order the Contractor in writing to suspend, delay, or interrupt all or any part of the Work for a period of time as he/she may determine to be appropriate for the convenience of the County.

(b) If the performance of all or any part of the Work is suspended, delayed, or interrupted for an unreasonable period of time by an act of the Engineer or the County, or by a failure of the Engineer or County to act within the time specified in this Contract (or if not time is specified, within a reasonable time), subject to the provisions of GC-4.06 and 4.07 an adjustment shall be made for any increase in the cost of performance of this Contract necessarily caused by an unreasonable suspension, delay, or interruption. However, no adjustment shall be made under this provision for any suspension, delay or interruption to the extent that performance would have been so suspended, delayed, or interrupted by any other cause, including the fault or negligence of the Contractor.

(c) By issuance of a written notice of suspension of work, the Engineer may order the Contractor to suspend, delay, or interrupt any part of the Work as a result of code violations or deviation from the Contract Documents. Should the violation or deviation persist, the Engineer may extend the suspension to all Work. The Engineer will enforce the suspension until such time as the Contractor completes the necessary correction. No equitable adjustment in the Contract Documents will be allowed for actions by the Engineer under this provision.

(d) If it should become necessary to suspend, delay, or interrupt all or part of the Work for an indefinite period, the Contractor shall store all materials in such manner that they will not obstruct or impede the traveling public unnecessarily nor become damaged in anyway. The Contractor shall take every precaution to prevent damage or deterioration of the work performed, provide suitable drainage by opening ditches, shoulder drain, etc. and erect temporary structures where necessary.

#### **GC-8.09      TERMINATION FOR DEFAULT-DAMAGES FOR DELAY – TIME EXTENSIONS**

(a) If the Contractor refuses or fails to prosecute the Work, or any separable part thereof, with such diligence as shall ensure its completion within the Contract Time, or any

extension thereof, or if the Contractor fails to complete said Work within the Contract Time, persistently fails to comply with laws, ordinances, rules, regulations, or orders of any public authority having jurisdiction, or otherwise materially breaches any of his/her obligations under the Contract Documents, the County may, in its sole discretion and without prejudice to any right or remedy against the Contractor and the Surety, by written notice to the Contractor, terminate for default the Contractor's right to proceed with the Work, or the part of the Work as to which there has been delay. In this event the County may take over the Work and prosecute the same to completion, by Contract or otherwise, and may take possession of and utilize the materials, appliances, and plant as may be on the site of the Work and necessary therefore in completing the Work.

**(b)** Liquidated damages as set forth in GC-8.10 are not intended to compensate the County after the Contractor's default for any additional expenses to complete the Work in accordance with the Contract Documents. If the County terminates the Contractor's right to proceed for default, the Contractor and the Surety are liable to the County and will pay within 30 days after demand by the County all additional costs incurred in completing the Work in excess of the Contract Sum (as modified by approved Change Orders) together with liquidated damages assessed in accordance with GC-8.10.

**(c)** If liquidated damages are provided in the Contract and if the County does not so terminate the Contractor's right to proceed under subsection (a) above, the resulting damage shall consist of the liquidated damages as outlines elsewhere in the Contract Documents.

**(d)** The Contractor's right to proceed may not be terminated nor the Contractor charged with resulting damages if:

**(1)** The delay in the completion of the Work arises from unforeseeable causes beyond the control and without the fault or negligence of the Contractor, including but not restricted to, acts of God, acts of the public enemy, acts of the County in either its sovereign or contractual capacity, fires, floods, epidemics, quarantine, restrictions, strikes, freight embargoes, unusually severe weather, or delays of subcontractors or suppliers arising from unforeseeable causes beyond the control and without the fault or negligence in whole or in part of either the Contractor or the subcontractors or suppliers; and

**(2)** The Contractor, within ten (10) days from the beginning of any such delay (unless the Engineer grants in writing a further period of time before the date of final payment under the Contract), notifies the Engineer in writing of the causes of delay. The Engineer shall ascertain the facts and the extent of the delay and extend the time for completing the Work when, in his/her judgment, the findings of fact justify such an extension, and his/her findings of fact shall be final and conclusive on the parties, subject only to appeal as provided in GC-5.13.

**(e)** If, after notice of termination for default, it is determined for any reason that the Contractor was not in default, or that the delay was excusable, the rights and obligations of the parties shall be the same as if the notice of termination had been issued pursuant to GC-8.11

(f) The rights and remedies of the County provided in this provision are in addition to any other rights and remedies provided by law or under this Contract.

(g) As used in paragraph (d) (1) of this provision, the term “subcontractors or suppliers” means subcontractors or suppliers at any tier.

#### **GC-8.10 LIQUIDATED DAMAGES**

(a) Time is an essential element of the Contract and it is important that the Work be vigorously prosecuted until Final Acceptance. The Contractor understands and agrees that the County and the general public will suffer financial loss and/or inconvenience if the Project is not substantially complete on the date set forth in the Contract Documents. The County and the Contractor agree that the amount of financial loss and/or inconvenience is not subject to accurate estimation and the actual damages are not easily ascertained. Therefore, the County and the Contractor agree that the amount of liquidated damages set forth in the Contract Documents is a reasonable forecast of the just and fair compensation for the harm that would result from the Contractor’s failure to timely complete the Work.

(b) For each calendar day that the Work shall remain uncompleted beyond the Contract Time, the Contractor and/or the Surety shall be liable for liquidated damages in the amount provided for in the Contract Documents, provided, however, that due account shall be taken of any adjustment of the Contract time for completion of work as granted by approved equitable adjustments.

#### **GC-8.11 TERMINATION FOR THE CONVENIENCE OF THE COUNTY**

(a) The performance of Work may be terminated by the County in accordance with this provision in whole, or from time to time in part, whenever the Director shall determine that such termination is in the best interest of the County. Any such termination shall be effected by delivery to the Contractor of a Notice of Termination specifying the extent to which performance of the Work is terminated, and the date upon which such termination becomes effective.

(b) After receipt of Notice of Termination, and except as otherwise directed by the Engineer, the Contractor shall:

(1) Stop the Work on the date and to the extent specified in the Notice of Termination;

(2) Place no further orders or subcontracts for materials, services or facilities, except as may be necessary for completion of the portion of the Work as is not terminated;

(3) Terminate all orders and subcontracts to the extent that they relate to the performance of the Portion of the Work terminated by Notice of Termination;

(4) Assign to the County in the manner, at the times, and to the extent directed by the Engineer, all of the right, title, and interest of the Contractor under the orders and subcontracts so terminated, in which case the County shall have the right, in its discretion, to settle or pay any or all claims arising out of the termination of such orders and subcontracts;

(5) Settle all outstanding liabilities and all claims arising out of the termination of orders and subcontracts, with the approval or ratification of the Engineer, to the extent he/she may require, which approval or ratification shall be final for all the purposes of this provision;

(6) Transfer title and deliver to the County, in the manner, at the times and to the extent, if any, directed by the Engineer, (a) the fabricated or non-fabricated parts, work in process, completed work, supplies, and other material produced as a part of, or acquired in connection with the performance of the Work terminated by the Notice of Termination, and (b) the completed or partially completed, drawings, information, warranties, and other property which, if the Contract had been completed, would have been required to be furnished to the County;

(7) Use his/her best effort to sell, in the manner, at the times, to the extent, and at the price or prices directed or authorized by the Engineer, any property of the types referred to in (6) above; provided, however, that the Contractor (a) may not be required to extend credit to any purchaser, and (b) may acquire any such property under the conditions prescribed by and at a price or prices approved by the Engineer; and provided further that the proceeds of any such transfer or disposition shall be applied in reduction of any payments to be made by the County to the Contractor under this Contract or shall otherwise be credited to the price or cost of the Work covered by this Contract or paid in such other manner as the Engineer may direct;

(8) Complete performance of such part of the Work as may not have been terminated by the Notice of Termination; and

(9) Take any action that may be necessary, or as the Engineer may direct, for the protection and preservation of the property related to this Contract that is in the possession of the Contractor and in which the County has or may acquire an interest. The Contractor shall submit to the Engineer a list, certified as to quantity and quality, of any or all items of termination inventory not previously disposed of, exclusive of items the disposition of which has been directed or authorized by the Engineer, and may request the County to remove such items or enter into a storage agreement covering them. Not later than fifteen (15) calendar days thereafter, the County shall accept title to such items and remove them or enter into a storage agreement covering the same; provided, that the list submitted shall be subject to verification by the Engineer upon removal of the items, or if the items are stored, within 45 days from the date of submission of the list, and any necessary adjustment to correct the list as submitted shall be made prior to final settlement.

(c) After receipt of a Notice of Termination, the Contractor shall submit to the Engineer his/her termination claim, in the form and with the certification required under GC-4.06 and GC-5.13 or as otherwise prescribed by the Engineer. This claim shall be submitted promptly

but in no event later than ninety (90) calendar days from the effective date of termination, unless one or more extensions in writing are granted by the Engineer, upon request of the Contractor made in writing within the ninety (90) calendar-day period or authorized extension thereof. Failure to submit the claim within the time specified herein shall operate as a waiver of claim regardless of whether the County incurred or demonstrates any prejudice by the failure to timely submit the claim. However, if the Engineer determines that the facts justify such action, he/she may receive and act upon any such termination claim at any time after the ninety (90) calendar-day period or any extension thereof. Upon failure of the Contractor to submit his/her termination claim within the time allowed or any extension thereof, the Engineer may determine, on the basis of information available to him/her, the amount, if any, due to the Contractor by reason of the termination and shall thereupon pay to the Contractor the amount, if any, so determined.

**(d)** Subject to the provisions of paragraph (C), the Contractor and the Engineer may agree upon the whole or any part of the amount or amounts to be paid to the Contractor by reason of the total or partial termination of the Work pursuant to this provision, which amount or amounts may include a reasonable allowance for profit on work done; provided, that such agreed amount or amounts, exclusive of settlement costs; shall not exceed the total Contract price as reduced by the amount of payments otherwise made and as further reduced by the price of work not terminated. The Contract shall be amended accordingly pursuant to GC-4.06. Nothing in paragraph (e) of this provision, prescribing the amount to be paid to the Contractor in the event of failure of the Contractor and the Engineer to agree upon the whole amount to be paid to the Contractor by reason of the termination of work pursuant to this provision, shall be deemed to limit, restrict, or otherwise determine or affect the amount or amounts that may be agreed upon to be paid to the Contractor pursuant to this paragraph.

**(e)** In the event of the failure of the Contractor and the Engineer to agree as provided in paragraph (d), upon the whole amount to be paid to the Contractor by reason of the termination of work pursuant to this provision, the Engineer shall pay to the Contractor the amounts determined by the Engineer as follows, but without duplication of any amounts agreed upon in accordance with paragraph (d):

**(1)** For completed supplies or services accepted by the County (or sold or acquired as provided in paragraph (b)(7) above) and for which payment has not theretofore been made, a sum equivalent to the aggregate price for the supplies or services computed in accordance with the price or prices specified in the Contract, appropriately adjusted for any saving of freight or other charges;

**(2)** The total of:

**(A)** The costs incurred in the performance of the terminated portion of the Work, including initial costs and preparatory expense allocable thereto, but exclusive of any costs attributable to supplies or services paid or to be paid for under paragraph (e)(1) hereof;

**(B)** The cost of settling and paying claims arising out of the termination of work under subcontracts or orders, as provided in

paragraph (b)(5) above, which are properly chargeable to the termination portion of the Contract (exclusive of amounts paid or payable on account of supplies or materials delivered or services furnished by subcontractors or vendors before the effective date of the Notice of Termination, which amounts shall be included in the costs payable under (a) above); and

**(C)** A sum, as profit on (a) above, determined by the Engineer to be fair and reasonable; provided, however, that if it appears that the Contractor would have sustained a loss on the entire Contract had it been completed, no profit shall be included or allowed under this subdivision (c) and an appropriate adjustment shall be made reducing the amount of the settlement to reflect the indicated rate of loss; and

**(D)** The reasonable cost of settlement accounting, legal, clerical, and other expenses reasonably necessary for the preparation of settlement claims and supporting data with respect to the terminated portion of the Work and for the termination and settlement of subcontracts thereunder, together with reasonable storage, transportation, and other costs incurred in connection with the protection or disposition of property allocable to the Contract; but

**(E)** No payment shall be allowed for any anticipated profit or overhead on work not performed.

**(3)** The total sum to be paid to the Contractor under (1) and (2) of this paragraph shall not exceed the total Contract price as reduced by the amount of payments otherwise made and as further reduced by the Contract price of work not terminated. Except for normal spoilage, and except to the extent that the County shall have otherwise expressly assumed the risk of loss, there shall be excluded from the amounts payable to the Contractor as provided in (e) (1) and (a) above, the fair value, as determined by the Engineer, of property that is destroyed, lost, stolen, or damaged so as to become undeliverable to the County or to a buyer pursuant to paragraph (b) (7).

**(f)** Costs claimed, agreed to, or determined pursuant to this provision must also be allowable, reasonable, lawful, and allocable to the Work and accounted for in accordance with generally accepted accounting principles. Guidance for any determination of whether the costs are allowable, reasonable, lawful, and allocable, will be provided by the “Contract Cost Principles and Procedures”, Title 21, Subtitle 09 of the Code of Maryland Regulations (COMAR 21.09.01), as may be amended from time to time.

**(g)** The Contractor shall have the right of appeal under GC-5.13 from any determination made by the Engineer under paragraph (c), (e), or (i) hereof, except that if the Contractor has failed to submit his/her claim within the time provided in paragraph (c) or (i) hereof, and has failed to request extension of such time, he/she shall have no such right of appeal. In any case where the Engineer has made a determination of the amount due under paragraph (d), (e), or (i) hereof, the County shall pay to the Contractor the following:



(1) If there is no right of appeal hereunder or if no timely appeal has been taken, the amount so determined by the Engineer; or,

(2) If an appeal has been taken, the amount finally determined on such appeal

(h) In arriving at the amount due the Contractor under this provision there shall be deducted:

(1) All non-liquidated advance or other payments on account theretofore made to the Contractor, applicable to the terminated portion of this Contract;

(2) Any claim that the County may have against the Contractor in connection with this Contract; and

(3) The agreed price for, or the proceeds of sale of, any materials, supplies, or other things acquired by the Contractor or sold, pursuant to this provisions, and not otherwise recovered by or credited to the County.

(i) If the termination hereunder is partial, the Contractor may file a claim with the Engineer for an equitable adjustment of the price or prices specified in the Contract relating to the continued portion of the Contract (the portion not terminated by the Notice of Termination), within the time limits and under the procedures set forth in GC-4.06 and GC-5.13.

(j) The County may, from time to time, under such terms and conditions as it may prescribe, make partial payments and payments on account against costs incurred by the Contractor in connection with the terminated portion of this Contract whenever, in the opinion of the Engineer, the aggregate of such payments shall be within the amount to which the Contractor shall be entitled hereunder. If the total of such payments is in excess of the amount finally agreed or determined to be due under this provision, such excess shall be payable by the Contractor to the County upon demand, together with interest computed at the prime rate established by the County Budget and Finance Office for the period of the date such excess payment is received by the Contractor to the date on which the excess is repaid to the County; provided, however, that no interest shall be charged with respect to any such excess payment attributable to a reduction in the Contractor's claim by reason of retention or other disposition of termination inventory until ten (10) days after the date of the retention or disposition, or a later date as determined by the Engineer by reason of the circumstance.

(k) Unless otherwise provided for in this Contract, or by applicable statute, the Contractor shall, from the effective date of termination until the expiration of three (3) years after final settlement (including the expiration and conclusion of all appeals and rights of appeal) under this Contract, preserve and make available to the County at all reasonable times at the office of the Contractor but without direct charge to the County, all his/her books, records, documents and other evidence bearing on the costs and expenses of the Contractor under this Contract and relating to the Work terminated hereunder, or, to the extent approved by the Engineer, photographs, microphotographs, or other authentic reproductions thereof.

## **GC-8.12 SUCCESSFUL TERMINATION OF CONTRACTOR'S RESPONSIBILITY**

(a) A contract will be considered as successfully fulfilled when all of the following conditions have occurred: (1) the Work has been completed in accordance with the terms of the Contract; (2) final Acceptance by the County has occurred; (3) the County authorizes Final payment; (4) the Contractor and the Surety have complied with all of their obligations; and (5) final payment has been made. Nothing herein will relieve the Contractor and the Surety from any future obligation such as a warranty, guarantee, guarantee bond, or indemnity obligation, or from responsibility for repair of latent defects discovered or appearing after final payment.

## **GC-SECTION 9 PAYMENT**

### **GC-9.01 SCOPE OF PAYMENT**

(a) If so identified in the Contract, payment to the Contractor will be made for the actual quantities of Contract items performed in accordance with the Contract Documents and if, upon completion of the work, these actual quantities show either an increase or decrease from the quantities given in the Bid form, the Contract unit prices will still prevail, except as provided in GC-4.04 Variations in Estimated Quantities.

(b) The payment of any partial estimate or of any retained percentage, except by and under the approved final estimate and voucher, in no way shall affect the obligation of the Contractor and the Surety to repair or renew any defective parts of the construction or to be responsible for all damages due to such defects.

(c) When requested in writing by the Contractor and approved by the Engineer, payment allowance will be made for nonperishable material to be incorporated in the Work delivered and stockpiled at the work site or other approved site. The Contractor must submit with the request a list of all such materials and their location. The Contractor shall submit back-up invoices, bills of lading, title documents, or such other documentation, satisfactory to the County, as will establish the County's title to the materials upon payment to the Contractor under the request. The Contractor must submit with the request proof of insurance in the amount of the payment requested to be maintained on the materials until such time as the materials are incorporated into the Work. Only those materials for which the Contractor can transfer clear title to the County will be qualified for payment. Payment for stored materials will be made in accordance with paragraph (f) below.

(d) When the Contractor requests payment allowance for stored materials under (c) above, the following terms and conditions will apply:

(1) For superstructure members delivered on the Project site, an allowance of one hundred (100) percent of the material cost plus freight charges as invoiced may be made

provided, however, that all such material will have been tested by the County and found to have met the Specifications or have been accepted under an approved certification program prior to such an allowance. The allowance will be based upon validated invoices or bills for such material including freight charges, and a copy thereof shall be made a part of the documented records for the Project.

(2) For reinforcing steel, piling, pipe, traffic barriers, signs and sign assemblies, and other nonperishable material in storage on the Project, but excluding aggregates, cement, seed, plants, fertilizer or other perishable items, an allowance of one hundred (100) percent of the invoiced cost of the material plus freight charges to the Contractor may be made when such material is delivered and stockpiled at the Project site, provided, however, that all such material will have been tested by the County and found to have met the Specifications or have been accepted under an approved certification program prior to such an allowance.

(3) No allowance will be made for fuels, form lumber, falsework, temporary structures or other materials of any kind, which will not become an integral part of the finished construction.

(4) Material for which an allowance is requested shall be stored in an approved manner in areas where damage is not likely to occur. If any of the stored materials are lost, stolen, or become damaged in any manner, the Contractor shall be responsible for repairing or replacing of such damaged materials. The Contractor expressly agrees to assume and bear the risk of all loss, theft, or damage to the materials. The value of the lost, stolen or damaged material will be deducted from the Contractor's subsequent requests for payment until replacement has been accomplished.

(5) When it is considered impractical to store materials on the actual project, the Engineer may approve storage areas in the vicinity of the actual project that will be considered at the Project site.

(6) When storage of the materials within Washington County is not practical, written approval must be obtained from the Engineer for storage elsewhere. Storage of materials outside of Washington County will be subject to the conditions set forth in this provision and, limited to materials exceeding twenty-five thousand dollars (\$25,000), which are designed and fabricated exclusively for use on a specific project.

(7) The request for allowances for any materials stored on property outside of Washington County shall be accompanied by a release and waiver from the owner and/or tenant of such property agreeing to permit verification by the Inspector that the material is stored at the approved location, to allow the removal of the material from the property without cost to Washington County, and waiving to the fullest extent possible any lien in favor of the owner and/or tenant for payment of any fees for access, storage, care, handling, or the like.

(8) Material, for which payment has been made, either wholly or partially, shall not be removed from the approved location until such time that it is to be incorporated into the Work, unless authorized by the Engineer.

payment: (9) The following prerequisites must also accompany the written request for

(A) Consent of Surety specifying the material type and the Item(s) in which the material is to be used;

(B) Validated invoices showing that payment for the material has been made by the Contractor;

(C) A notarized statement from the Contractor attesting that the invoices, as submitted do not include charges and/or fees for placing, handling, erecting or any other charges and/or markups other than the actual material cost, sales tax(s), if applicable, and freight charges;

(D) Bills of lading showing delivery of the material; and

(E) Inspection test reports, certifications and/or a written statement from the Inspector attesting to the inspection and approval of the material.

(10) Upon receipt of the above by the Engineer and verification by the Inspector that the material is stored at the approved location, the Engineer may authorize payment by a unit of measure based upon the receipted invoices under the appropriate existing items of the Contract. A ratio will be established by the Engineer between the dollar amount of the material as invoiced and the quantity the material represents from the appropriate Bid Items.

(11) Copies of all pertinent data shall be made and distributed to the Inspector for retention as part of the documented records for the Project.

(12) No payment will be made for stored materials when it is anticipated they will be incorporated into the Work within thirty (30) days of receipt by the Engineer of the written request.

(13) Unless otherwise stated by the Engineer in writing, payment on account of a request for payment for stored materials transfers title to the County but does not constitute an acceptance by the Engineer or the County of the materials nor does it constitute an agreement that the materials conform to the Contract Documents. Notwithstanding the fact that payment has been made on account of the request for payment for stored materials, the Contractor and the Surety continue to be responsible to ensure at all times that the materials are in full conformance with the Contract Documents and are free from defect. Moreover, payment on account of a request for payment for stored materials does not begin the running of any applicable warranty or guaranty.

(14) Final payment shall be made only for materials actually incorporated in the Work and, upon final acceptance, title to all materials remaining for which advanced payment have been made shall revert to the Contractor, unless otherwise agreed, and the

payments made for these items shall be deducted from the final payment due to the Contractor for the Work.

(15) The Contractor agrees to indemnify and save harmless the County and all of its representatives from all suits, actions, or claims of any character brought on account of or arising out of the storage of materials for which the County has made payment on account of a request for payment for stored materials, including any claims of a warehouseman's or garageman's lien for cost of storage of the equipment and for claims arising out of damage or injury caused by the materials and their shipping and handling.

(e) Contractor shall indicate his/her Federal Taxpayer Identification Number on the face of each invoice billed to the County. The Contractor may also be required to provide additional information as determined by federal and/or state funding agencies.

(f) Along with each request for payment, the Contractor shall furnish the following certification signed by an officer or principal of the Contractor, or payment shall not be made:

I hereby certify, to the best of my knowledge and belief, that –

(1) The amounts requested are only for performance in accordance with the Specifications, terms and conditions of the Contract Documents;

(2) Payments to all subcontractors and suppliers have been made from previous payments received under the Contract, and timely payments will be made from the proceeds of the payment covered by this certification; and

(3) This request for progress payments does not include any amounts that the Contractor intends to withhold or retain from a subcontractor or supplier in accordance with the terms and conditions of the subcontract.

\_\_\_\_\_  
(Name)

\_\_\_\_\_  
(Title)

\_\_\_\_\_  
(Date)

**GC-9.02 FORCE ACCOUNT WORK**

When the Contractor is required to perform work as a result of additions or changes to the Contract for which there are no applicable unit prices in the Contract, the County and Contractor shall make every effort to come to an agreed upon price for the performance of such work. If an

agreement cannot be reached, the County may require the Contractor to do such work on a force account basis to be compensated in accordance with the following:

**(a) Labor** – For all labor and for foremen in direct charge of the specific operations, the Contractor shall receive the actual wages for each and every hour that labor and foremen are actually engaged in the force account work.

In addition, an amount equal to sixty-five (65) percent of the wages will also be paid the Contractor which shall include, but not limited to the following as full compensation for all cost paid to, or in behalf of, workman by reason of subsistence and travel allowances, health and welfare benefits, pension fund benefits, or other benefits that may be required by collective bargaining agreement or other employment contract generally applicable to property damage, liability and workmen's compensation insurance premiums, unemployment insurance contributions, and Social Security taxes on the force account work.

To substantiate labor cost for the force account, the Contractor shall submit copies of certified payrolls showing name, classification, date, daily hours, total hours, rate, and extension for each laborer and foreman.

**(b) Materials** – For materials accepted by the Engineer and used, the Contractor shall receive the actual cost of such materials delivered on the force account work, including transportation charges paid by him (exclusive of machinery rentals as hereinafter set forth).

In addition to the actual cost of materials and transportation charges, the Contractor may charge a fee of twenty (20) percent of the actual costs. To substantiate materials and transportation costs, the Contractor shall submit original receipted invoices. The County reserves the right to furnish materials as it deems appropriate and the Contractor shall have no claim for any costs, overhead, or profit on these materials.

**(c) Equipment.**

**(1)** For any machinery or special equipment (other than small tools, whether rented or owned), the use of which has been authorized by the Engineer, the Contractor shall receive the rates agreed upon in writing before such work is begun, or the Contractor shall receive those rates which may be specified elsewhere in the Contract Documents. For the purpose of definition, equipment with a new cost of \$500 or less will be considered small tools.

**(2)** In the event no agreement is reached and if the Contract Documents do not indicate the applicable rate(s), the Contractor shall use the current rental rates recommended in the Rental Rate Blue Book for Construction Equipment published by Data Quest, Inc. using the applicable Blue Book rate adjustment tables in effect at the time of the authorization of the force account work for the use of any machinery or special equipment authorized by the Engineer. Rental rates must be agreed upon in writing before work is begun, except in those cases where the Engineer finds that an emergency exists. Payment will be made for the actual number of hours the equipment is required to work at the site. The maximum number of hours allowed for each working day will be eight (8) or the number of hours in operation, whichever is greater. The

rate to be paid per hour will be computed by dividing the monthly rate by one hundred and seventy-six (176). Premium rates shall not be allowed.

(3) Approved transportation charges will be paid from and to the nearest source if the equipment is brought to the Project specifically for use on the force account work and is not used on any other work.

(4) The rental rate will consist of the sum of the following:

(A) the rate for the basic piece of equipment;

(B) the rate for attachments (where applicable); and

(C) the estimated hourly operating cost (where applicable).

(5) These component parts of the rate are to be obtained from the Rental Rate Blue Book when listed in that book. If a piece of equipment is not listed in the Rental Rate Blue Book, then the rate will be the prevailing rate being paid in the area where the force account work is being performed. When equipment is used in excess of eight hours per day or forty (40) hours per week, the excess time will be considered as overtime. The rental rates for this overtime will be the sum of (A), fifty (50) percent of (B) and one hundred (100) percent of (C) above.

(6) Whenever equipment is ordered by the Engineer to be held on the Project on a standby basis, or when the County is obligated for other reasons to pay for idle equipment, then the rate will be 75 percent of the monthly rental rate with no allowance for operating costs calculated as set forth in Paragraph (c)(2) above. Standby or idle time cannot exceed eight (8) hours per day and will not be allowed for Saturday and Sunday. Non-operating time for equipment required for force account work is not considered standby or idle time if the equipment is operated and used at least once during each working day.

(d) **Materials and Supplies Not Incorporated in the Work** – For materials and supplies expended in the performance of the force account work (excluding those required for rented equipment) and approved by the Engineer, the Contractor shall receive the actual cost of such materials and supplies used. The Contractor shall receive a reasonable allowance for materials used but not expended in the performance of the force account work.

(e) **Subcontractors** – The Contractor shall receive the actual cost of the force account work performed by a subcontractor. Subcontractor's cost is to be determined as in (a), (b), (c), and (d) above, plus the fixed fee for overhead and profit allowance computed as in (g), below.

(f) **Superintendence** – No additional allowance shall be made for general superintendence, the use of small tools, or other costs for which no specific allowance is herein provided.

**(g) Compensation** – The compensation as set forth above shall be received by the Contractor as payment in full for change order work done on a force account basis. At the end of each day, the Supervisor and the Engineer shall compare records of the cost of work as ordered on a force account basis.

**(h) Statements** – No payment will be made for work performed on a force account basis until the Contractor furnishes the Engineer duplicate itemized statements of the cost of such force account work detailed as to the following:

**(1)** Name, classification, date, daily hours, total hours, rate, and extension for such laborer or foreman.

**(2)** Designation, dates, daily hours, total hours, rental rate, and extension for each unit of machinery and equipment.

**(3)** Quantities of materials, prices and extensions.

**(4)** Transportation of materials.

**(5)** Payments of items under (h) (1) shall be accomplished by copies of certified payrolls. Under (h) (2) original receipted invoices for rentals must be provided if requested by the Engineer. Paragraphs (h) (3) and (h) (4) shall be accompanied by original receipted invoices for materials used and transportation charges. If, however, the materials used in the force account work are not specifically purchased for such work but are taken from the Contractor's stock, then in lieu of the original invoices the statements shall contain or be accompanied by an affidavit of the Contractor which shall certify that such materials were taken from his/her stock, that the quantity claimed was actually used and that the price and transportation of the material as claimed represent actual cost. Any request for payment under this provision shall be submitted in the order outlined by the above.

**(i)** Costs claimed, agreed to, or determined pursuant to this provision must also be allowable, reasonable, lawful, and allocable to the Work and accounted for in accordance with generally accepted accounting principles. Guidance for any determination of whether the costs are allowable, reasonable, lawful, and allocable, will be provided by the "Contract Cost Principles and Procedures", Title 21, Subtitle 09 of the Code of Maryland Regulations (COMAR 21.09.01) or as may be amended from time to time.

### **GC-9.03 PROGRESS PAYMENTS**

**(a)** Within ten (10) calendar days after the date of the Notice to Proceed and prior to commencing work, the Contractor shall submit a breakdown of all lump sum items (a "Schedule of Values") within the Bid for review and approval as may be required by the Engineer. No partial payments will be made for lump sum items if the Contractor fails to provide a Schedule of Values. If the Engineer does not approve the Schedule of Values submitted by the Contractor, within ten (10) days of receipt of written notice of disapproval, the Contractor shall submit a revised breakdown for review and approval.



**(b) Monthly Estimates** – Each month the County will pay the Contractor for the Contract value of the work satisfactorily performed as determined from the approved Schedule of Values during the preceding calendar month, including authorized extras and additions less ten percent (10%), if the Contractor submits a request for payment on the form approved by the County. Unless otherwise reduced in the discretion of the Engineer and approved by the Director, the ten (10) percent of the total Contract value retained by the County will not be released until final payment (unless partially released in a semi-final payment), except as described in (d), below. Current estimates will be based upon the Engineer’s estimate of quantity (including materials and equipment complete in place) satisfactorily performed for each item contained in the Contractor’s approved Schedule of Values. In the instance of lump sum items, the Engineer’s estimate shall be the proper fraction of the lump sum items satisfactorily performed during the preceding month. All quantities, estimates and fractions will be reasonably accurate approximations and are subject to correction (a) in subsequent current estimates, (b) in any semi-final estimate and, (c) in final payment. Should either the Engineer or the Contractor be of the opinion that any estimates, quantities and/or fractions (either as to an individual current estimate or accumulations thereof) do not represent a reasonably accurate approximation of actual work, then details questioned shall be reviewed and then any corrections adjusted for in the next current estimate.

**(c)** The Engineer may decline to approve a monthly request for payment and may withhold his/her semi-final approval in whole or in part, to the extent reasonably necessary to protect the County, from loss because of:

- (1)** Defective work not remedied;
- (2)** Third party claims filed or reasonable evidence indicating the probability of filing of such claims;
- (3)** Failure of the Contractor to make payments properly to Subcontractors or for labor, materials or equipment;
- (4)** Reasonable doubt that the Work can be completed for the unpaid balance of the Contract Sum;
- (5)** Damage to another contractor;
- (6)** Reasonable indication that the Work will not be completed within the Contract Time; or
- (7)** Unsatisfactory prosecution of the Work by the Contractor.

**(d)** Upon completion of fifty percent (50%) of the Contract value, the Contractor may request reduction in the monthly retainage to no less than five percent (5%) if, in the opinion of the Director, the following conditions apply:

(1) The Contractor has diligently pursued the work and is on-time or ahead of the approved schedule,

(2) Work completed to date is satisfactory and acceptable to the County,

(3) The Contractor has made reasonable payment and compensation to all subcontractors and suppliers,

(4) There are no outstanding claims against the County precipitated by the Contractor's work or that of his subcontractors and suppliers,

(5) There are no conditions imposed by grant funding agencies that preclude such reductions,

(6) The Contractor's surety provides written consent to the reduction.

If the Contractor is granted a reduction in retainage, it is to be expressly understood that the Director reserves the right to reconsider the reduction in retainage.

(e) Progress payments requesting more than seventy-five percent (75%) of scheduled values in Mechanical and Electrical Trades will be reduced to include only seventy-five percent (75%) on the Mechanical and Electrical line items if the Contractor fails to submit preliminary Maintenance Manuals with contents specified by Contract Documents and of quality acceptable to the County.

(f) Within seven (7) calendar days of the receipt of a progress payment, the Contractor shall make payment to all Subcontractors in the amount for which payment has been received by the Contractor for the portion of the Work performed by the Subcontractor as reflected on the Request for Payment. The Contractor shall require all Subcontractors to make payment to any further Subcontractors within seven (7) calendar days of the Subcontractor's receipt of payment from the Contractor for the portion of the Work performed by the lower tier Subcontractor. The parties expressly intend for all Subcontractors to be third party beneficiaries of this provision and all Subcontractors can enforce this provision in any appropriate proceedings.

#### **GC-9.04 SUBSTANTIAL COMPLETION AND FINAL PAYMENT**

##### **(a) Verification of Final Quantities**

(1) When the Contractor has completed the Work, and it has been accepted as substantially complete, the Engineer will proceed:

(A) To make any necessary final surveys;

**(B)** To complete any necessary computation of quantities; and

**(C)** To submit a tabulation of the proposed final quantities to the Contractor for his/her consideration, within thirty (30) calendar days after final completion and acceptance of the Work by the Engineer for maintenance. This tabulation shall be accompanied by a statement setting forth: **(a)** the additional work performed under change orders and/or supplemental agreements; **(b)** the authorized extension of time; **(c)** the number of days that have been charged against the Contractor as having been used to complete the Contract, and **(d)** any deductions, charges or liquidated damages that have been made or imposed.

**(2)** The Contractor shall then have a period of ten (10) calendar days, dating from the date upon which he/she received the aforementioned tabulation from the County, in which:

**(A)** To decide whether or not it will accept final payment upon such a basis; and

**(B)** To notify the County, in writing, of its decision. The Contract may request an additional period up to ten (10) calendar days in which to notify the County of its decision. In the event the Contractor notifies the County that he protests final payment on such a basis, that notification shall outline the reason(s) for said protest.

**(3)** Upon receipt of a notification of acceptance as provided for in paragraph (a) (2) above, the Contractor shall prepare the final estimate and final payment forms and submit them to the County for execution and payment. These forms shall show all data noted in paragraph (a) (1) above, together with deductions for all prior payments. Such action by the County shall be deemed to constitute acceptance and final payment.

**(4)** In the event the Contractor does not accept the data submitted to him as described in paragraph (a)(1) above and/or has outstanding a claim filed in accordance with GC-5.13, the Engineer and the Contractor shall confer at mutually convenient times and endeavor to expeditiously reconcile all points of disagreement. If such reconciliation is accomplished, the County will promptly proceed with acceptance and final payment on the reconciled basis and in accordance with the provisions of paragraph (a) (3), above. If reconciliation is not accomplished within thirty (30) calendar days, the decision of the Engineer is deemed to be the final action. The Engineer shall promptly furnish a copy of the final decision to the Contractor by certified mail, return receipt requested. The decision may be appealed by the Contractor as set forth in GC-5.13.

**(5)** All prior partial estimates and payments shall be subject to correction at the time of acceptance and final payment and if the Contractor has been previously overpaid, the amount of such overpayment shall be set forth in the Final Payment forms and the Contractor

hereby agrees that he/she will reimburse the County for such overpayment within thirty (30) calendar days of receipt of such advice.

(6) Payment for the full apparent value of the Contract shall become due and payable to the Contractor within ninety (90) calendar days after determination of final quantities under this section. As a condition precedent to final payment, the Contractor shall be required to execute a general release of all claims against the County arising out of, or in any way connected with, this Contract.

**(b) Substantial Completion**

(1) Substantial completion is the stage in the progress of the Work when the Work or designated portion thereof is sufficiently complete in accordance with the Contract Documents so the County can occupy or utilize the Work for its intended use.

(2) When the Contractor considers that the Work, or a portion thereof which the County agrees to accept separately, is substantially complete, the Engineer shall prepare and submit to the Contractor a comprehensive list of items to be completed or corrected. The Contractor shall proceed promptly to complete and correct items on the list. Failure to include an item on such list does not alter the responsibility of the Contractor to complete all Work in accordance with the Contract Documents. Upon receipt of the Contractor's list, the Engineer will make an inspection to determine whether the Work or designated portion thereof is substantially complete. If the Engineer's inspection discloses any item, whether or not included on the Contractor's list, which is not in accordance with the requirements of the Contract Documents, the Contractor shall, before issuance of the Certificate of Substantial Completion, complete or correct such item upon notification by the Engineer. The Contractor shall then submit a request for another inspection by the Engineer to determine Substantial Completion. When the Work or designated portion thereof is substantially complete, the Engineer will prepare a Certificate of Substantial Completion which shall establish the date of Substantial Completion, shall establish responsibilities of the County and Contractor for security, maintenance, heat, utilities, damage to the Work and insurance, and shall fix the time within which the Contractor shall finish all items on the list accompanying the Certificate.

(3) Upon issuance of the Certificate of Substantial Completion, the Engineer shall determine a reasonable sum of money for completion of the items on the list accompanying the Certificate. The County, upon application by the Contractor for a substantial completion payment for the apparent estimated final value of the Contract deducting the total of all amounts previously paid to the Contractor as current estimates and sums deemed chargeable against the Contractor properly deductible, including liquidated damages and the amount determined by the Engineer as a reasonable cost of completing the items on the list accompanying the Certificate of Substantial Completion and as a retainage a sum not less than five percent (5%) of the total value of the Contract.

(4) **Partial Acceptance for Maintenance.** If at any time during the performance of the Work the Contractor substantially completes a unit or portion of the Work, he/she may request the Engineer to make final inspection of that unit. If the Engineer finds upon

inspection that the unit has been satisfactorily completed in compliance with the Contract, he/she may accept that unit as being completed and the Contractor may be relieved of further maintenance responsibility for that unit. Generally, partial acceptance for maintenance will only be considered when the County feels that such action is in the public interest. Such partial acceptance for maintenance shall in no way void or alter any of the terms of the Contract.

**(c) Final Completion, Final Acceptance and Final Payment.**

(1) Upon receipt of written notice that the Work is ready for final inspection and acceptance and upon receipt of a final Application for Payment, the Engineer will promptly make such inspection and, when the Engineer finds the Work acceptable under the Contract Documents and the Contract fully performed, the Engineer will promptly issue a Certificate of Final completion stating that to the best of the Engineer's knowledge, information and belief, the Work has been completed in accordance with terms and conditions of the Contract Documents. After the Certificate of Final Completion has been issued by the Engineer, the County will assume responsibility for maintenance of the Work except as expressly provided elsewhere in the Contract Documents. The Contractor shall then submit a final payment requisition to the Engineer, along with the items set forth in subparagraph (c) (2).

(2) Neither final payment nor any remaining retained percentage shall become due until the Contractor submits to the Engineer (1) an affidavit that payrolls, bills for materials and equipment, and other indebtedness connected with the Work have been paid or otherwise satisfied, (2) a certificate evidencing that insurance required by the Contract Documents to remain in force after final payment is currently in effect and will not be canceled or allowed to expire until at least 30 days' prior written notice has been given to the County, (3) a written statement that the Contractor knows of no substantial reason that the insurance will not be renewable to cover the period required by the Contract Documents, (4) consent of Surety, if any to final payment and (5), if required by the County, other data establishing payment or satisfaction of obligations, such as receipts, releases and waivers of liens, claims, security interests or encumbrances arising out of the Contract, to the extent and in such form as may be designated by the County.

(3) If, after Substantial Completion of the Work, final completion thereof is materially delayed through no fault of the Contractor or by issuance of Change Orders affecting final completion, and the Engineer so confirms, the County shall, upon application by the Contractor and certification by the Engineer, and without terminating the Contract, make payment of the balance due for that portion of the Work fully completed and accepted. If the remaining balance for Work not fully completed or corrected is less than retainage stipulated in the Contract Documents, and if bonds have been furnished, the written consent of Surety to payment of the balance due for that portion of the Work fully completed and accepted shall be submitted by the Contractor to the Engineer prior to certification of such payment. Such payment shall be made under terms and conditions governing final payment, except that it shall not constitute a waiver of claims.

(d) The making of final payment shall constitute a waiver of all claims by the County except those arising from:

- (1) Any indemnity obligations of the Contractor;
  - (2) Faulty or defective Work appearing after Substantial Completion
  - (3) Failure of the Work to comply with the requirements of the Contract Documents;
  - (4) Terms of any special guarantees required by the Contract Documents; or
  - (5) Failure of the Contractor to procure or maintain any insurance required by the Contract Documents.
- (e) The acceptance of final payment shall constitute a waiver of all claims by the Contractor.

#### **GC-9.05 MEASUREMENTS OF QUANTITIES**

(a) **Measurements of Quantities By The Engineer** – With the exception of those items of work to be paid by lump sum, after the Work is completed and before final payment is made therefore, the Engineer will make final measurements to determine the quantities of various items of work performed as the basis for final settlement for all items of work. In the case of unit price items, the Contractor will be paid for the actual amount of work performed and for the actual amount of materials in place, in accordance with the Specifications as shown by the Engineer's final measurement. All work completed under the Contract will be measured by the Engineer according to the standards of weights and measures recognized by the National Bureau of Standards.

(b) **Longitudinal/Transverse Measurements** – All longitudinal measurements for area will be made along the actual surface and not horizontally, and no deductions will be made for individual fixtures in the payment having an area of nine (9) square feet or less. For all transverse measurements for area of base course and pavements, the dimensions to be used in calculating the pay area will be the neat dimensions shown on the as-built Plans or ordered in writing by the Engineer.

(c) **Structures** – Structures will be measured according to neat lines shown on the Plans or as ordered in writing, unless otherwise provided for elsewhere in the Contract Documents.

(d) **Measurements by Volume** – Volumes of excavation, tamped fill, and borrow pits will be calculated from cross sections and the use of average end area formulae. Volumes of other work such as masonry, removal of masonry, etc. will be calculated by using arithmetic formulae. Where the volume is bounded by varying dimensions and there are no simple volumetric formulae applicable, frequent cross sections will be taken and the volume computed from average end area formulae.

(e) **Cement** – Cement will be measured by weight in hundredweight (cwt) units.

(f) **Measurements By The Linear Foot** – All items which are measured by the linear foot, such as pipe culverts, traffic barriers, underdrains, etc., will be measured parallel to the base or foundation centerline upon which such structures are placed, face of manhole to face of manholes, unless otherwise shown on the Plans.

(g) **Measurements By Gage** – The term “gage” when used in connection with the measurement of uncoated steel sheet and light plates shall mean the U.S. Standard Gage, except that when reference is made to the measurements of galvanized or aluminum sheets used in the manufacture of corrugated metal pipe, metal plate pipe culverts and arches, and metal cribbing, the term gage shall mean that specified in AASHTO M 36, M 167, M 196, or M 197. When the term gage refers to the measurement of wire, it shall mean the wire gage specified in AASHTO M 32.

(h) **Measurements By The Ton** – The term “ton” shall mean the short ton consisting of 2,000 pounds avoirdupois. All materials that are specified for measurement by the ton shall be weighed on accurate, approved scales meeting the requirements of National Bureau of standards Handbook 44. A digital recorder and printout shall be required on all truck scales. The digital recorder shall produce a printed record of the gross, tare, net weights, the time, date, truck identification and project number. Provisions shall be made so that the scales may not be manually manipulated during the printing process. The system shall be interlocked so as to allow printing only when the scale has come to rest. Except for computer-operated scales, all weights shall be certified by a bonded weigh person supplied by the Contractor, producer, or supplier. The security bond shall be one hundred thousand dollars (\$100,000). If material is shipped by rail, the car weight may be accepted but the payment will be limited to the actual weight of material. Car weights will not be acceptable for material to be passed through mixing plants.

(i) **Measurements By The Cubic Yard** – All materials for which measurements are obtained by the cubic yard, loose measurement or measured in the vehicle shall be hauled in approved vehicles and measured therein at the point of delivery. No allowance will be made for the settlement of material in transit. Approved vehicles for this purpose shall be of any size or type acceptable to the Engineer, provided that the body is of such shape that the actual contents may be readily and accurately determined. Unless all approved vehicles are of uniform capacity, each approved vehicle must bear a plainly legible identification mark indicating the specific approved capacity. All vehicles shall be loaded to at least their water level capacity, and all loads shall be leveled when the vehicles arrive at the point of delivery.

When requested by the Contractor and approved by the Engineer in writing, material specified to be measured by the cubic yard may be weighed, and such weights will be converted to cubic yards for payment purposes. Factors for conversion from weight measurement to volume measurement will be determined by the laboratory and shall be agreed to by the Contractor before such method of measurement of pay quantities will be approved by the Engineer.

(j) **Bituminous Material** – Bituminous material will be measured by volume in the railroad tank car, tank truck, distributor tank or drums in which it is delivered. Each railroad tank car, tank truck, drum or distributor tank of bituminous material delivered for the Project will be measured. The measurements will be taken when the bituminous material is of a uniform temperature and free from air bubbles, and the temperature of the material will be recorded. The volumetric measurement of the bituminous material for these Specifications will be based upon temperature of 60° F. Reference is made to ASTM D1250, Petroleum Measurement Tables, and ASTM D633, Volume correction Table for Tars. Only the quantity of bituminous material actually placed in the Work and accepted will be considered in determining the amount due the Contractor.

(k) **Timber** – Timber will be measured by the thousand feet board measure (MBM) actually incorporated in the structure. Measurement will be based on nominal widths and thickness and the extreme length of each piece.

(l) **Lump sum** – The term “lump sum” when used as an item of payment will mean complete payment for the unit of work described. When a complete element, structure of structural unit (in effect, lump sum work) is specified as the unit measurement, the unit will be construed to include all necessary fittings and accessories.

(m) **Equipment Rental** – Rental of equipment will be measured by time in hours of actual working time, moving in and moving out costs, if any, and necessary traveling time of the equipment within the limits of the project except when special conditions make some other method of measurement desirable.

(n) **Sanitary Sewer and Water Mains And Accessories** – Measurement of sanitary sewer and water mains and their accessories shall be as noted elsewhere in the Contract Documents.